

# Mémoires

de la SOCIÉTÉ MATHÉMATIQUE DE FRANCE

**Numéro 121**  
**Nouvelle série**

**A FUNDAMENTAL DOMAIN FOR  $V_3$**

Mary REES

**2 0 1 0**

**SOCIÉTÉ MATHÉMATIQUE DE FRANCE**

Publié avec le concours du Centre National de la Recherche Scientifique

---

*Comité de rédaction*

Jean BARGE	Charles FAVRE
Emmanuel BREUILLARD	Daniel HUYBRECHTS
Gérard BESSON	Yves LE JAN
Antoine CHAMBERT-LOIR	Laure SAINT-RAYMOND
Jean-François DAT	Wilhem SCHLAG
Raphaël KRIKORIAN (dir.)	

*Diffusion*

Maison de la SMF	Hindustan Book Agency	AMS
Case 916 - Luminy	O-131, The Shopping Mall	P.O. Box 6248
13288 Marseille Cedex 9	Arjun Marg, DLF Phase 1	Providence RI 02940
France	Gurgaon 122002, Haryana	USA
smf@smf.univ-mrs.fr	Inde	www.ams.org

*Tarifs*

*Vente au numéro* : 28 € (\$42)  
*Abonnement* Europe : 255 €, hors Europe : 290 € (\$435)  
Des conditions spéciales sont accordées aux membres de la SMF.

*Secrétariat : Nathalie Christiaën*

Mémoires de la SMF  
Société Mathématique de France  
Institut Henri Poincaré, 11, rue Pierre et Marie Curie  
75231 Paris Cedex 05, France  
Tél : (33) 01 44 27 67 99 • Fax : (33) 01 40 46 90 96  
revues@smf.ens.fr • <http://smf.emath.fr/>

© Société Mathématique de France 2010

*Tous droits réservés (article L 122-4 du Code de la propriété intellectuelle). Toute représentation ou reproduction intégrale ou partielle faite sans le consentement de l'éditeur est illicite. Cette représentation ou reproduction par quelque procédé que ce soit constituerait une contrefaçon sanctionnée par les articles L 335-2 et suivants du CPI.*

ISSN 0249-633-X  
ISBN 978-85629-301-0

Directrice de la publication : Aline BONAMI

---

A FUNDAMENTAL DOMAIN FOR  $V_3$

Mary Rees

*Mary Rees*

Department of Mathematical Sciences, University of Liverpool, Peach St., Liverpool  
L69 7ZL, U.K.

*E-mail* : [maryrees@liv.ac.uk](mailto:maryrees@liv.ac.uk)

*Url* : <http://www.liv.ac.uk/~maryrees/maryrees.homepage.html>

# A FUNDAMENTAL DOMAIN FOR $V_3$

Mary Rees

**Abstract.** – We describe a fundamental domain for the punctured Riemann surface  $V_{3,m}$  which parametrises (up to Möbius conjugacy) the set of quadratic rational maps with numbered critical points, such that the first critical point has period three, and such that the second critical point is not mapped in  $m$  iterates or less to the periodic orbit of the first. This gives, in turn, a description, up to topological conjugacy, of all dynamics in all type III hyperbolic components in  $V_3$ , and gives indications of a topological model for  $V_3$ , together with the hyperbolic components contained in it.

**Résumé (Un domaine fondamental pour  $V_3$ ).** – Nous décrivons un domaine fondamental pour la surface de Riemann  $V_{3,m}$  qui paramétrise (à conjugaison près) l'ensemble des fonctions rationnelles par le biais des points critiques énumérés, de manière à ce que le premier point critique ait une période de 3, et que le deuxième point critique ne soit pas envoyé sur le premier après  $m$  itérations ou moins. Cela nous fournit une description, à conjugaison topologique près, des dynamiques de toutes les composantes de type III en  $V_3$ , et nous donne des indications sur un modèle topologique de  $V_3$ , au même temps que l'ensemble des composantes hyperboliques qui y sont contenues.



# CONTENTS

<b>1. Introduction</b> .....	1
<b>2. The space <math>V_3</math></b> .....	7
2.1. About $V_n$ .....	7
2.2. Polynomials and Type II components in $V_3$ .....	8
2.3. Lamination maps .....	11
2.4. Thurston equivalence .....	12
2.5. Some notation .....	14
2.6. Captures and Matings .....	14
2.7. Captures in $V_3$ .....	16
2.8. Trivial Thurston equivalences between captures in $V_3$ .....	16
2.9. Symbolic Dynamics .....	19
2.10. The Main Theorem (first version) .....	22
<b>3. Captures and Counting</b> .....	25
3.1. Some nontrivial equivalences between captures .....	25
3.3. Equivalences between captures $\sigma_p \circ s_{3/7}$ , for $p \in (\frac{2}{7}, \frac{1}{3}) \cup (\frac{2}{3}, \frac{5}{7})$ .....	30
3.4. Numbers of type III components .....	33
3.5. Check on the numbers in Theorem 2.10 .....	43
<b>4. The Resident's View</b> .....	47
4.1. ....	47
4.2. The maps $\Phi_1, \Phi_2, \rho$ .....	48
4.3. The Resident's View of Rational Maps Space .....	51
4.4. Identifying $D'$ .....	52
4.5. The arc set $\Omega_0$ and the image under $\rho$ .....	54
<b>5. Fundamental Domains</b> .....	59
5.1. Fundamental domains: a restricted class .....	59
5.2. Fundamental Domains: construction from graphs and from matching pairs of adjacent path pairs .....	59
5.3. Examples of Fundamental domains: the graph from a Julia set .....	61
5.4. Fundamental domain for the whole group .....	62
5.5. Fundamental domains for increasing numbers of punctures .....	63

5.6. Specifying to $V_{3,m}$ .....	64
5.7. ....	66
5.8. Checking vertex group elements .....	67
<b>6. Easy cases of the Main Theorem</b> .....	69
6.1. Restatement of the Main Theorem in the easy cases .....	69
6.2. Derivation of the first version of the Main Theorem from the second ....	70
6.3. Proofs in the easy cases .....	71
<b>7. The hard case:</b>	
<b>final statement and examples</b> .....	73
7.1. ....	73
7.2. Some conjugacy tracks .....	73
7.3. Another sequence of homeomorphisms .....	80
7.4. Hard part of the fundamental domain: the first few cases .....	83
7.5. Definition of $w_i(w, 0)$ and $w'_i(w, 0)$ .....	97
7.6. Definition of $U^x$ and $w_i(w, x, 0)$ and $w'_i(w, x, 0)$ .....	100
7.7. Properties with prefixes .....	102
7.8. Definition of the paths $\beta(w, x, 0)$ .....	103
7.9. Path-crossings and adjacency: preservation under inverse images .....	104
7.10. Notes on the definition of paths in $R_{m,p}$ for $p > 0$ .....	105
7.11. Final statement in the hard and interesting case .....	106
<b>8. Proof of the hard and interesting case</b> .....	109
8.1. The inductive construction .....	109
8.4. Adjacent elements in $R_{m,0}$ : how many $S^1$ -crossings are the same? .....	112
8.5. Definition of $\xi_{m,0}$ and $\xi_{m,1}$ .....	114
8.6. Comparing $\xi_n$ and $\xi_{n,0}$ and $\xi_{n,1}$ .....	115
8.7. Definition of $U(\beta_1, \beta_2)$ .....	117
8.9. Preservation of $U(\beta_1, \beta_2)$ under local inverses .....	120
8.10. Definition of $V(\beta_1, \beta_2, n)$ .....	121
8.12. Unsatisfying the Inadmissibility Criterion of 4.4 .....	127
<b>9. Open Questions</b> .....	129
9.1. Continuity of the Model .....	129
9.2. Some nontrivial equivalences between captures .....	134
<b>Bibliography</b> .....	137



# CHAPTER 1

## INTRODUCTION

In this paper, we give a complete description of half the hyperbolic components in a certain parameter space of quadratic rational maps. The parameter space is known as  $V_3$ , and consists of all maps

$$h_a : z \mapsto \frac{(z-a)(z-1)}{z^2}, \quad a \in \mathbb{C}, a \neq 0.$$

This map has two critical points,

$$c_1 = 0, \quad c_2 = c_2(a) = \frac{2a}{a+1},$$

and  $c_1$  is periodic of period 3, with orbit

$$0 \mapsto \infty \mapsto 1 \mapsto 0.$$

There is thus one free critical point,  $c_2$ . Describing the hyperbolic components in  $V_3$  — and in fact only half, or in numerical terms, two thirds of them — might seem rather a modest project, but has, in fact, been ongoing for some twenty years, and has generated an extensive theory, which will be summarized, as far as it concerns us here, in Section 4. It is essentially because of technical difficulties in the development of the theory that only half the hyperbolic components in  $V_3$  are described. A conjectural picture for the remaining half is not too hard to obtain. Remarks are made on this at various points, but no explicit description is given.

One can obviously ask why  $V_3$  has been chosen. The space  $V_n$  is the space of quadratic rational maps with one critical point of period  $n$ , quotiented by Möbius conjugacy. A quadratic rational map with one fixed critical point is Möbius conjugate to a quadratic polynomial. Any quadratic polynomial is affinely conjugate to one of the form

$$f_c : z \mapsto z^2 + c$$

for some  $c \in \mathbb{C}$ , and this, thus, is the space  $V_1$ . This parameter space must be one of the most studied in all dynamics. There are several reasons for this. One is that dynamics within this parameter space is rich and varied. Another is that there is

a pretty full description of the variation of dynamics within this parameter space, at least up to topological conjugacy, and at least conjecturally. Another is that this conjectural description of the dynamics, which is very detailed, but not fully complete, and which includes a conjecture on the topology of the Mandelbrot set, is still not proved, although there has been very interesting progress recently. The missing piece has analogues in the theory of Kleinian groups — where the corresponding problem has been solved [3, 4, 5, 8, 9, 26, 33] — not to mention other, less well-understood, parameter spaces of holomorphic maps. So there are attractively simple questions one can ask, even in this case, which have very detailed, but not complete, answers, and one hopes that this case will shed some light on other parameter spaces of holomorphic maps.

Actually, the parameter space of quadratic polynomials differs from most other parameter spaces in one very fundamental respect. There is a natural “base” map in the space of quadratic polynomials, namely, the map  $f_0 : z \mapsto z^2$ , and for any hyperbolic map  $f$  (and hopefully some nonhyperbolic also) in the connectedness locus — also called the Mandelbrot set — there is an essentially unique description of the dynamics of  $f$  in terms of  $f_0$ . This is because the complement of the Mandelbrot set is simply connected, and the Mandelbrot set itself has a natural tree-like structure. There appears to be essentially one natural path from  $f_0$  to  $f$  within the Mandelbrot set. This is very far from being the case in other parameter spaces of quadratic rational maps, although the structure of  $V_2$  is quite simple, as we shall indicate — but not prove — in Section 2.

For  $n \geq 3$ ,  $V_n$  identifies with the family of quadratic rational maps

$$f_{c,d} : z \mapsto 1 + \frac{c}{z} + \frac{d}{z^2}$$

( $d \neq 0$ ) for which the critical point 0 is constrained to have period  $n$ . If  $n \geq 3$ , then the maps  $f_{c,d} \in V_n$  are in one-to-one correspondence with Möbius conjugacy classes of quadratic rational maps  $f$  with named critical point  $c_1(f)$  of period  $n$ , where we use only conjugacies which map  $c_1(f)$  to 0. These parameter spaces were the main objects of study in [29, 30, 31]. The main point of [29, 30] was that it is possible to describe dynamics of hyperbolic maps  $f_{c,d}$  in  $V_n$  in terms of a path from some fixed base map  $g_0$  - and, of course, in terms of that base map  $g_0$ . In [29] we used a polynomial (up to Möbius conjugacy) as base, and the resulting theorem was called the *Polynomial-and-Path Theorem*. It was shown that a path in parameter space from  $g_0$  to  $f_{c,d}$  gave rise to a path in the dynamical plane of  $g_0$ . So the theorem showed how to define  $f_{c,d}$  in terms of  $g_0$  and the path in the dynamical plane of  $g_0$ . The main problems with such a result were, firstly, identifying which paths in the dynamical plane of  $g_0$  were associated with paths in  $V_n$ , and therefore, with hyperbolic maps in  $V_n$ , and secondly, to determine when two paths gave rise to a description of the

same map in  $V_n$ . Some progress was made in [30] in restricting the set of paths in the dynamical plane of  $g_0$  to a smaller set, which still described all hyperbolic maps in  $V_n$ . Further progress along these lines looked difficult.

In [31] there was a fundamental change of policy. The underlying idea in [29, 30] had been to attempt a conjectural description of parameter space  $V_n$ , with its hyperbolic components, as a quotient of a subset of some sort of universal cover of the dynamical plane of some suitable base map  $g_0$ . This “universal cover” was an artificial construct. Basically, the idea was to remove all points in the full orbit of the period  $n$  critical point of  $g_0$ , but it was not clear what was the right way to do this.

In 1990 I decided to stop guessing on this, and just attempt to describe finitely many - but arbitrarily finitely many - hyperbolic components at a time, by looking at the universal cover of the complement, in the dynamical plane of a base map  $g_0$ , of just finitely many points in the full orbit of the period  $n$  critical point. There was at least no problem about what this universal cover was. Immediately, a whole lot of structure became clear. Nevertheless, the proofs of the structure took a little over 10 years to write down correctly. Moreover, this was just a start. This was basically a topological result, describing the topology of parameter space minus finitely many hyperbolic components in terms of the complement of finitely many points in the dynamical plane of  $g_0$ . So there was no comprehensive view of the whole of parameter space. In fact, technical difficulties meant that about half of all hyperbolic components — those of type IV — were omitted from consideration.

Hyperbolic components of quadratic rational maps come in four types. There is only one *type I* component, for which both critical points are attracted to the same attractive fixed point. This hyperbolic component intersects  $V_n$  only for  $n = 1$ , and contains  $z \mapsto z^2 + c$  for all large  $c$ . So it can be omitted from consideration if we are considering  $V_n$  only for any  $n \geq 2$ . A *type II component of period  $n$*  is one in which both critical points are in periodic components of the attractive basin of an attractive periodic point of period  $n$ . In this case, the critical points must be in different components of the attractive periodic basin. For any fixed period  $n$ , there are only finitely many type II hyperbolic components for attractive periodic basins of period  $n$ . A *type III component of preperiod  $m$*  is one in which both critical points are in the full attractive basin of a single attractive periodic point, with one critical point in a periodic component (there must be at least one such), and the other in a nonperiodic component whose  $m + 1$ 'st forward iterate is periodic.

A *type IV* hyperbolic component is one in which the critical points are in periodic components of attractive periodic points in distinct orbits. The intersection of a type IV component with  $V_n$  has *period  $m$*  if the period of the immediate attractive basin containing  $c_2$  is  $m$ . There are finitely many type III (or type IV) components of preperiod (or period)  $m$  intersecting  $V_n$ , for any integer  $m$ , but infinitely many altogether.

We shall see that the number of type III components in  $V_3$  of preperiod  $m$  can be computed exactly, and is  $(1 + \frac{2}{21}) \cdot 2^{m+1} + O(1)$ . This is also the number of type IV components of period  $m + 1$  in  $V_3$ .

The description of the hyperbolic components in  $V_1$ , the space of quadratic polynomials, is part of a description which conjecturally gives much more information, not just combinatorial, but topological and possibly geometric. Exactly one hyperbolic component in  $V_1$  — the type I component mentioned above — is unbounded, and was shown by Douady and Hubbard [10] in the 1980's to be simply connected, once  $\infty$  is added. The complement is a closed set known as the *Mandelbrot set*. Hyperbolic components in  $V_1$  are in 1-1 correspondence with subsets in the *combinatorial Mandelbrot set*. The Mandelbrot set  $M$  is conjecturally homeomorphic to the combinatorial Mandelbrot set  $M_c$ . There is a natural monotone map  $\Phi : M \rightarrow M_c$ , which is rather easily shown to be continuous, in the same way as a monotone map defined on a subset of  $\mathbb{R}$ , with dense image in  $\mathbb{R}$ , can be shown to extend continuously. The question, therefore, is whether  $\Phi$  is injective. Injectivity at parabolic points is relatively easy, though far from trivial. Much deeper results derive from use of the *Yoccoz parapuzzle*. It is known, for example, that  $\Phi$  is injective at all points of  $M$  that are not infinitely renormalisable. (This is equivalent to the more usual statement that the Mandelbrot set is locally connected at all points that are not infinitely renormalisable.) Recently, some 15 years after Yoccoz first demonstrated his methods, these techniques have been used by Kahn and Lyubich and collaborators [2, 13, 14, 15, 16, 17] to prove similar results about unicritical polynomials, and to extend the results to some infinitely renormalisable quadratic polynomials.

Given the history of these techniques, it is over-optimistic to expect imminent application in other examples of parameter spaces, but there are certain features of the Yoccoz parapuzzle, and the Branner-Hubbard parapuzzle ([6, 7]) for the complement of the connectedness locus for cubic polynomials, which it is certainly worth noticing and trying to emulate. These parapuzzles are decompositions of parameter spaces, arise from Markov partitions of maps in the parameter space, Markov partitions which persist at least locally in parameter space. Such parapuzzles arising from Markov partitions have also been used by Kiwi [21] to describe other families of cubic polynomials and to describe polynomials and rational maps on a certain non-Archimedean field. In the case of quadratic polynomials, Yoccoz uses a different Markov partition in each limb. In summary, persistent Markov partitions can give rise to parapuzzles and can be used to extract topological information about parameter spaces. So it seems interesting that the description of hyperbolic components in  $V_3$  does involve the use of Markov partitions, three simple finite partitions and one countably infinite partition. They do give a topological model for the parameter space  $(V_3, H)$ , where  $H$  is the union of type III hyperbolic components, together with dynamical information

about the components. The model essentially identifies the parameter space locally with a subset of a fixed dynamical plane. But there is a difference from other models of parameter spaces, which may be significant. The identification of parameter space with dynamical plane is not one-to-one, but unboundedly-finite-to-one, on the part of parameter space associated with the countably infinite Markov partition mentioned above. The topological picture is purely conjectural, and in fact no conjecture is being formalized at this stage, but it is a start. Countable Markov partitions have not arisen as parapuzzles before, to my knowledge, and they are not likely to be easy to use. Nevertheless, the way this one arises, and its nature, is perhaps the most striking aspect of the current work. See Section 9 for some very preliminary remarks on how this might develop.

The organisation of this paper is as follows. In Section 2 we collect together essentially elementary information about  $V_3$ , and recall some of the key concepts to be used, such as Thurston equivalence, captures and matings. Most of this material has, at least, been around for some considerable time. This section ends with a first statement of the main theorem. In Section 3, we describe some less trivial equivalences between captures. This section ends with some straightforward counting, which might seem rather basic, but counting provides a very important check. In Section 4 we summarize theory from earlier papers as it will be needed, in particular the Resident's View of [31]. In Section 5 we consider the simple question of how fundamental domains are found in general, and specialize to our context. We give a second, rather vague, statement of the main theorem. In Section 6, we give the final statement of the main theorem in the three "easy" cases, and prove these. Section 7 is largely given up to examples, showing how to calculate the fundamental domain for the first few preperiods in the "hard" region, and illustrating factors that have to be taken into account as the preperiod increases. The final statement of the "hard" case of the main theorem is given at the end of the section. The proof is given in Section 8. In Section 9 we give some questions arising from this work.

I am greatly indebted to Vladlen Timorin, who read an earlier version of this paper, who made very perceptive suggestions on how to improve the presentation of the work, both on general strategy and on the level of detail. I have tried to respond to his suggestions as best I can. His suggestions and comments were concentrated on the first half of the work. During revision, quite substantial errors were found in the "hard" case of the theorem, necessitating a restatement, and, of course, new details of proof. This version of the paper is therefore quite significantly different from the 2005 version.

I should like to thank the referee of this paper for some very helpful comments, undoubtedly produced after a lot of hard work.



## CHAPTER 2

### THE SPACE $V_3$

#### 2.1. About $V_n$

The map

$$f_{c,d}(z) = 1 + \frac{c}{z} + \frac{d}{z^2}$$

has critical points

$$0, \quad \frac{-2d}{c},$$

and critical values

$$f_{c,d}(0) = \infty, \quad f_{c,d}(-2d/c) = 1 - \frac{c^2}{4d}.$$

Also  $f_{c,d}(\infty) = 1$ . So if  $n \geq 3$ , the set of maps  $f_{c,d}$  for which 0 is of period  $n$  is an algebraic curve minus finitely many punctures, defined by a polynomial in  $(c, d)$ . For example,  $V_3$  identifies with the plane  $1 + c + d = 0$  ( $d \neq 0$ ). It is shown in Stimson's thesis [37], and also in Chapter 7 of [31], that  $V_n$  is nonsingular, that is, the only singularities on the algebraic curve containing it occur at points with  $d = 0$  or with both  $c, d \rightarrow \infty$ . See also [24, 25].

We shall sometimes refer to 0 as the *first critical point*  $c_1$ , and its image  $\infty$  under  $f_{c,d}$  as the *first critical value*  $v_1$ , to  $-2d/c$  as the *second critical point*  $c_2$  or, more precisely,  $c_2(f_{c,d})$ , and the image  $1 - (c^2/4d)$  under  $f_{c,d}$  as the *second critical value*  $v_2$  or  $v_2(f_{c,d})$ . For  $m \geq 0$ , we define  $V_{n,m}$  to be the set of  $f_{c,d}$  for which the  $m$ 'th image of  $v_2$  is not in the periodic orbit of  $0 = c_1$ , that is,  $f_{c,d}^{m+1}(-2d/c) \neq f_{c,d}^j(0)$  for any  $j \geq 0$ , equivalently, for any  $0 \leq j < n$ . This is the complement in  $V_n$  of finitely many points. If  $n = 3$  and  $m = 0$ , then this identifies with the set of  $d$  in  $\mathbb{C} \setminus \{0, \pm 1\}$  with  $1 + c + d = 0$ . The set  $V_{n,0}$  is the complement in  $V_n$  of the centres of the type II components. For  $m \geq 1$ , the set  $V_{n,m}$  is the complement in  $V_{n,0}$  of the centres of type III components of preperiod  $\leq m$ . So  $V_{n,m+1} \subset V_{n,m}$  for all  $m$ . For all  $n \geq 3$ , the universal cover of  $V_{n,m}$ , for any  $m \geq 0$ , is conformally the unit disc  $D$ . We write  $P_{n,m}$  for the set of punctures of  $V_{n,m}$ , that is, the union of the sets of singularities of  $V_n$ , of centres of type II components, and of centres of type III components of

preperiod  $\leq m$ . In the case  $n = 3$ , we have  $0, \infty, \pm 1 \in P_{3,m}$  for all  $m \geq 0$ . The other punctures are the centres of the type III hyperbolic components of preperiod  $\leq m$ . The space  $V_{n,m}$  identifies naturally with a subspace of a larger space  $B_{n,m}$ . The structure of  $B_{n,m}$  was the main subject of [32]: it is a countable union of geometric pieces connected by handles. One of the geometric pieces is  $V_{n,m}$ . For a degree two branched covering  $g$ , we number the two critical values  $v_1 = v_1(g)$  and  $v_2 = v_2(g)$ . Suppose that  $v_1$  is periodic, of period  $n$ . Write

$$Z_m(g) = g^{-m}(\{g^j(v_1) : j \geq 0\}), \quad Y_m(g) = Z_m(g) \cup \{v_2\}.$$

Then  $B_{n,m}$  is defined to be the space of all triples  $[g, Z_m(g), v_2(g)]$ , such that  $v_1(g)$  is of period  $m$  and  $v_2(g) \notin Z_m(g)$ , where  $[\cdot]$  denotes the quotient by Möbius conjugation preserving the numbering of critical values. Hence,  $[g, Z_m(g), v_2(g)] = [h, Z_m(h), v_2(h)]$  if and only if there is a Möbius transformation  $\sigma$  such that  $\sigma \circ g \circ \sigma^{-1} = h$ , and  $\sigma(v_i(g)) = v_i(h)$  for  $i = 1, 2$ . This automatically implies that  $\sigma(Z_m(g)) = Z_m(h)$ . We write  $N_{n,m}$  for the set of topological (Freudenthal) ends of  $B_{n,m}$ . Then  $P_{n,m}$  identifies with the set of ends of  $V_{n,m}$ , and with a subset of  $N_{n,m}$ . Overall, it turns out that many of the ends of  $B_{n,m}$  identify naturally with spaces of critically finite branched coverings with  $v_2$  of preperiod  $\leq m$  [31].

For the remainder of this paper, we restrict to the study of the case  $n = 3$ , with some reference to the case of  $n = 1$ , that is, the space  $V_1$  of quadratic polynomials, and a few references to the case  $n = 2$ . Note that  $V_{3,m}$  is a punctured sphere for all  $m \geq 0$ . Also, we can dispense with Möbius conjugation in the definition of  $B_{3,m}$  if we take all branched coverings  $g$  in  $B_{3,m}$  to have  $c_1 = 0$ ,  $v_1 = \infty$  and  $g(v_1) = 1$ , as is true for  $V_{3,m}$ , which identifies with a subset of  $B_{3,m}$ . In Chapter 1 of [31] it is shown that  $(V_{3,0}, P_{3,0})$  is homotopy equivalent, under inclusion, to  $(B_{3,0}, N_{3,0})$ . But for all  $m > 0$  inclusion of  $(V_{3,m}, P_{3,m})$  in  $(B_{3,m}, N_{3,m})$  is injective, but not surjective, on  $\pi_1$ . That is a long story.

## 2.2. Polynomials and Type II components in $V_3$

We start with a picture of  $V_3$ , in which polynomials (up to Möbius conjugacy) and type II hyperbolic components are marked.



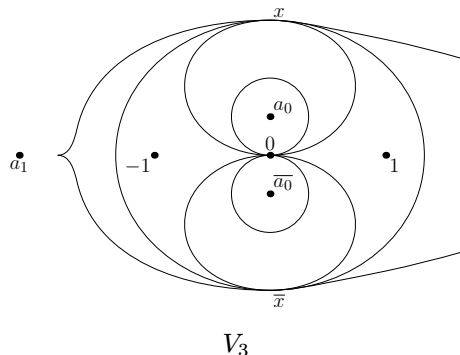

We write

$$h_a(z) = \frac{(z - 1)(z - a)}{z^2}.$$

The critical points are  $0 = c_1$  and

$$c_2 = c_2(a) = \frac{2a}{a + 1}.$$

The critical values are  $\infty = v_1$  and

$$v_2 = v_2(a) = -\frac{(a - 1)^2}{4a}.$$

There are three polynomials up to Möbius conjugacy in  $V_3$ , represented by the conjugate parameter values  $a = a_0$  or  $\bar{a}_0$  and the real value  $a = a_1 < -1$ . There are two type II hyperbolic components, containing  $\pm 1$  respectively, and  $h_{\pm 1}$  is the unique critically finite map in its hyperbolic component. For  $h_1$ , the critical points are 0 and 1 and the critical values are  $\infty$  and 0. For  $h_{-1}$ , the critical points are 0 and  $\infty$ , and the critical values are  $\infty$  and 1. The hyperbolic components  $H_{\pm 1}$  are drawn, identifying them with subsets of  $\mathbb{C}$  and, as the very rough sketch indicates, their boundaries meet in three accessible points: 0,  $x$  and  $\bar{x}$ , where  $x \in \mathbb{C}$  satisfies  $\text{Im}(x) > 0$ . The points  $a_0$ ,  $\bar{a}_0$  and  $a_1$  are then contained in distinct components of the complement of  $H_1 \cup H_{-1}$ . The points  $a_0$  and  $\bar{a}_0$  are contained in bounded components of  $\mathbb{C} \setminus (H_1 \cup H_{-1})$ , and hence their hyperbolic components  $H_{a_0}$  and  $H_{\bar{a}_0}$  are also contained in these bounded sets. The point  $a_1$  and its hyperbolic component are contained in the unique unbounded component of  $\mathbb{C} \setminus (H_1 \cup H_{-1})$ . This hyperbolic component is also drawn, and, as indicated, it also has as accessible boundary points  $x$  and  $\bar{x}$ . Proof of accessibility of  $x$  and  $\bar{x}$  is very similar to case 4b) of the Theorem of [28]. There is a natural parametrisation of  $H_1$  (or  $H_{-1}$ ) by the unit disc, using the Böttcher coordinate of the second critical value. Write  $\varphi_a$  for the map such that

$$\varphi_a(z^2) = h_a^3 \circ \varphi_a(z), \quad \varphi_a(0) = 1, \quad \varphi'_a(0) = 1.$$

Then  $|\varphi_a^{-1}(v_2(a))| < 1$  and

$$\Phi_1 : a \mapsto \varphi_a^{-1}(v_2(a))$$

is a degree three branched covering map from  $H_1$  to the open unit disc, with 0 as the unique branch point. The result of 4b) of [28] says that each of the three components of  $\Phi_1^{-1}(\{r\zeta : r \in [0, 1]\})$  has a unique limit point as  $r \rightarrow 1$ , if  $\zeta$  is a root of unity,  $\zeta \neq 1$ . The limit point is a parabolic parameter value, also in the closure of a type IV hyperbolic component. The Thurston equivalence class of the centre of this type IV hyperbolic component can be computed from the centre of the type II hyperbolic component — in the current case, the hyperbolic component is  $H_1$ , with centre  $h_1$  — and the choice of  $\zeta$  and component of  $\Phi_1^{-1}(\{r\zeta : r \in [0, 1]\})$ . The result also holds for  $\zeta = 1$ , and a particular component of  $\Phi_1^{-1}(\{r : r \in [0, 1]\})$  if the associated critically finite branched covering is known to be Thurston equivalent to a rational map. (This is proved in exactly the same way as the result in [28].) In the case of  $H_1$ , the branched coverings associated to two of the components of  $\Phi_1^{-1}(\{r : r \in [0, 1]\})$  are indeed equivalent to rational maps. The branched covering associated to the third component is not equivalent to a rational map, but in that case the component has  $a = 0$  as a unique accumulation point. It is not possible to be more precise without pre-empting the definition of mating in Section 2.6, and the subsequent results.

Now we fix some notation which will be used later. For any  $a$  such that  $h_a$  is hyperbolic, we write  $H_a$  for the intersection with  $V_3$  of the hyperbolic component of  $h_a$ . We write  $V_3(a)$  for the component of  $V_3 \setminus (H_1 \cup H_{-1})$  containing  $a$ ,  $a = a_0$  or  $\bar{a}_0$ , respectively. Write  $V_3(a_1, -)$  for the bounded component of  $V_3 \setminus (H_1 \cup H_{-1} \cup H_{a_1})$  — which intersects only the negative real axis — and  $V_3(a_1, +)$  for the unbounded component of  $V_3 \setminus (H_1 \cup H_{-1} \cup H_{a_1})$  — which intersects only the positive real axis. We write  $V_{3,m}(a) = V_3(a) \cap V_{3,m}$ ,  $P_{3,m}(a) = P_{3,m} \cap V_3(a)$ , and so on.

The polynomial represented by  $a_0$  is often known as the rabbit polynomial, because of the shape of its Julia set. The Julia set for  $\bar{a}_0$  is the conjugate of that for  $a_0$ . The rabbit polynomial for  $a = a_0$  has the critical attractive basin rotated anticlockwise to the critical value attractive basin, the next one round. To check this, it suffices to show that for  $a$  near 0 in the upper half plane in the hyperbolic component of  $a_0$ , the multiplier at the fixed point in the common boundary of the attractive basins is near  $e^{2\pi i/3}$ . Now this has to be a repelling fixed point, and, since  $a$  is in the hyperbolic component of a polynomial, there also has to be an attractive fixed point, and the multiplier there has to be near  $e^{-2\pi i/3}$ . Now this is easily checked. The fixed points of  $h_a$  are the roots of

$$F(z, a) = 1 - \frac{a+1}{z} + \frac{a}{z^2} - z = 0,$$

which for  $a$  near 0 are near the roots of

$$F(z, 0) = 1 - \frac{1}{z} - z = 0,$$

that is

$$z - 1 - z^2 = 0$$

or  $z = e^{\pm\pi i/3}$ . The multiplier at a fixed point is

$$\frac{a+1}{z^2} - \frac{2a}{z^3}.$$

Fix  $\zeta$  with  $F(\zeta, 0) = 0$ . Thus,  $\zeta = e^{\pm i\pi/3}$ . Let  $z(a)$  be continuous in  $a$  near  $a = 0$  with  $z(0) = \zeta$  and  $F(z(a), a) = 0$ . Then the Taylor expansion of  $z(a)$  in  $a$  near 0 is  $z = \zeta(1 + ca) + o(a)$  with  $c\zeta = -(\partial F/\partial a)(\zeta, 0)/(\partial F/\partial z)(\zeta, 0)$ . So

$$c = \frac{\bar{\zeta} - \zeta}{|1 + \zeta|^2} = -2i \frac{\text{Im}(\zeta)}{|1 + \zeta|^2},$$

which is purely imaginary, and the derivative is

$$-\zeta(a+1)(1-2ca) + 2a + o(a) = -\zeta(1+a(1+2\zeta^2) - 2ca).$$

So the modulus is  $< 1$  if and only if

$$\text{Re}(1 + a(1 + 2\zeta^2) - 2ca) < 0.$$

Since  $1 + 2\zeta^2$  is purely imaginary and equal to  $2\text{Im}(\zeta)$ , the modulus is  $< 1$  if and only if

$$2\text{Im}(\zeta)\text{Im}(a) + 4 \frac{\text{Im}(\zeta)}{|1 + \zeta|^2} \text{Im}(a) > 0.$$

If the multiplier at  $\zeta$  is near  $e^{-2\pi i/3}$ , then since the derivative is approximately  $\zeta^{-2}$ , we must have  $\zeta = e^{i\pi/3}$  and  $\text{Im}(a) > 0$ , as claimed.

The immediate disc regions containing  $a_0$  and  $\bar{a}_0$  indicate the sets  $H_{a_0}$  and  $H_{\bar{a}_0}$ . The next largest regions in parameter space are the regions  $V_3(a_0)$  and  $V_3(\bar{a}_0)$ . It is known that all hyperbolic components in these regions are matings or captures with  $h_{a_0}$  or  $h_{\bar{a}_0}$ . These include a mating with the polynomial represented by  $a_1$  in each case. These hyperbolic components are adjacent to the points  $x$  and  $\bar{x}$  respectively. The points  $x$  and  $\bar{x}$  are also common boundary points of the sets  $H_1$  and  $H_{-1}$ , and in the boundary of the set  $H_{a_1}$ , which is unbounded. There are two other regions of  $V_3$  which contain infinitely many hyperbolic components. One is the region  $V_3(a_1, -)$  bounded by  $H_{-1}$  and  $H_{a_1}$ , and the other is the region  $V_3(a_1, +)$  bounded by  $H_1$  and  $H_{a_1}$ .

### 2.3. Lamination maps

Invariant laminations were introduced by Thurston [39] to describe the dynamics of polynomials with locally connected Julia sets. The theory is most developed for quadratic polynomials, but a number of people have worked on developing the theory for higher degree polynomials, e.g. [18], [19], [20]. See also [29] (and [31]) for a slightly more detailed summary in the quadratic case than is given here. The *leaves* of

a lamination  $L$  are straight line segments in  $\{z : |z| \leq 1\}$ . Invariance of a lamination means that if there is a leaf with endpoints  $z_1$  and  $z_2$  then there is also a leaf with endpoints  $z_1^2$  and  $z_2^2$ , a leaf with endpoints  $-z_1$  and  $-z_2$ , and a leaf with endpoints  $w_1$  and  $w_2$  where  $w_1^2 = z_1$  and  $w_2^2 = z_2$ . A leaf with endpoints  $e^{2\pi i a_1}$  and  $e^{2\pi i a_2}$  for  $0 \leq a_1 < a_2 < 1$ , is then said to have *length*  $\min(a_2 - a_1, a_1 + 1 - a_2)$ . *Gaps* of the lamination are components of  $\{z : |z| < 1\} \setminus (\cup L)$ . If the longest leaf of  $L$  has length  $< \frac{1}{2}$  then there are exactly two with the same image which is called the *minor leaf*. A lamination is *clean* if finite-sided gaps are never adjacent. Minor leaves of clean laminations are either equal or have disjoint interiors. For a clean lamination, the lamination equivalence relation  $\sim_L$  is closed, where the nontrivial equivalence classes are the leaves of  $L$  and closures of finite-sided gaps of  $L$ . The quotient space  $\overline{\mathbb{C}}/\sim_L$  is a topological sphere. A partial order on minor leaves is therefore defined by:  $\mu_1 \leq \mu_2$  if  $\mu_1$  separates  $\mu_2$  from 0. For any minor leaf  $\mu$ , the set  $\{\mu' : \mu' \leq \mu\}$  is totally ordered, and has a unique minimal element. If the gap containing 0 has infinitely many sides, then it is periodic, and one can define a *lamination map*  $s = s_L$  which maps  $L$  to  $L$ ,  $s(z) = z^2$  for  $|z| \geq 1$ , and maps gaps to gaps. Such a lamination is uniquely determined by its minor leaf. The laminations with this property are precisely those with minor leaf with endpoints  $e^{2\pi i a_1}$  and  $e^{2\pi i a_2}$ , where  $a_1$  and  $a_2$  are odd denominator rationals, of the same period under the map  $x \mapsto 2x \pmod{1}$ . We can then choose  $s$  so that 0 is critical and periodic under  $s$ , of the same period as the gap containing 0, and as the endpoints of the minor leaf, which bounds the gap containing  $s(0)$ . Since a lamination map  $s_L$  preserves  $L$ , it descends to a map  $[s_L] : \overline{\mathbb{C}}/\sim_L \rightarrow \overline{\mathbb{C}}/\sim_L$ . Any quadratic polynomial  $f_c : z \mapsto z^2 + c$ , for which 0 is periodic, is *Thurston equivalent* (to be defined in the next section) to exactly one such lamination map  $s$ , and topologically conjugate to the quotient lamination map  $[s]$ , and conversely.

Let  $p$  be any odd denominator rational. We write  $L_p$  for the invariant lamination with minor leaf with endpoint at  $e^{2\pi i p}$ , and  $\mu_p$  for this minor leaf. Thus,  $L_p = L_q$  if and only if either  $p = q$  or  $e^{2\pi i p}$  and  $e^{2\pi i q}$  are at opposite ends of the minor leaf of  $L_p = L_q$ . We write  $s_p$  for  $s_{L_p}$ . The maps  $h_a$  for  $a = a_0, \overline{a_0}$  and  $a_1$  are conjugate to quotient lamination maps  $[s_{1/7}]$ ,  $[s_{6/7}]$  and  $[s_{3/7}]$  respectively. These will feature large in our description of the type III hyperbolic components in  $V_3$ .

## 2.4. Thurston equivalence

Thurston's notion of equivalence of critically finite branched coverings, and Thurston's Theorem which characterizes those critically finite branched coverings which are equivalent to rational maps, underpins this work. A topological branched covering  $f : \overline{\mathbb{C}} \rightarrow \overline{\mathbb{C}}$  is *critically finite* if

$$X(f) = \{f^n(c) : n > 0, c \text{ critical}\}$$

is a finite set. In the current work the definition of  $f$  also includes a fixed identification of  $X(f)$  with a finite set  $X_0$  with dynamics such that the identification preserves dynamics. Two critically finite maps  $f_0$  and  $f_1$  are (*Thurston*) *equivalent* if there is a homotopy  $f_t$  from  $f_0$  to  $f_1$  such that  $\#(X(f_t))$  is constant in  $t$ , and thus the finite set  $X(f_t)$  varies isotopically with  $t$ , and the isotopy between  $X(f_0)$  and  $X(f_1)$  preserves identification with  $X_0$ . If  $\#(X(f_t)) \geq 3$ , this is equivalent to the existence of homeomorphisms  $\varphi$  and  $\psi : \overline{\mathbb{C}} \rightarrow \overline{\mathbb{C}}$  with  $\varphi$  and  $\psi$  isotopic via an isotopy mapping  $X(f_0)$  to  $X(f_1)$ , preserving the identifications of  $X(f_0)$  and  $X(f_1)$  with  $X_0$ , and such that

$$\varphi \circ f_0 \circ \psi^{-1} = f_1.$$

Thurston's theorem gives a characterization of those critically finite branched coverings which are equivalent to rational maps. For this characterization the reader is referred, for example, to 1.8 and 2.4 of [31], or to [11]. But it is worth noting that, if  $f_0$  and  $f_1$  are equivalent to a hyperbolic rational map, then Thurston's Theorem says that the rational map is unique up to Möbius conjugacy, and its Thurston equivalence class in the space of branched coverings is simply connected if  $\#(X(f_0)) \geq 3$ . This depends on our definition of Thurston equivalence as being via isotopies preserving identification with  $X_0$ . It follows that  $\varphi$  and  $\psi$  are unique up to isotopy constant on  $X(f_0)$ , and  $\psi$  is actually unique up to isotopy constant on  $f_0^{-1}(X(f_0))$ . In the situation described here, we write

$$f_0 \simeq_{\varphi} f_1,$$

which is slightly dubious notation as  $\simeq_{\psi}$  is not an equivalence relation, although Thurston equivalence certainly is. We shall sometimes write

$$(f_0, X(f_0)) \simeq_{\varphi} (f_1, X(f_1)),$$

meaning that conjugacy by  $\varphi$  is followed by an isotopy constant on  $X(f_1)$ . Note that since  $\varphi$  and  $\psi$  are isotopic via an isotopy constant on  $X(f_0)$ , there is a homeomorphism  $\psi_2 : \mathbb{C} \rightarrow \mathbb{C}$  which maps  $f_0^{-1}(X(f_0))$  to  $f_1^{-1}(X(f_1))$  defined by the relation

$$f_0 \circ \psi_2 = \psi \circ f_0.$$

We thus have

$$f_0 \simeq_{\psi} f_1,$$

or more precisely

$$(f_0, f_0^{-1}(X(f_0))) \simeq_{\psi} (f_1, f_1^{-1}(X(f_1))).$$

Similarly we have

$$(f_0, f_0^{-2}(X(f_0))) \simeq_{\psi_2} (f_1, f_1^{-2}(X(f_1))).$$

We can similarly define  $\psi_n$  for all  $n$  with

$$(f_0, f_0^{-n}(X(f_0))) \simeq_{\psi_n} (f_1, f_1^{-n}(X(f_1))).$$

See also 1.7 of [31] and 1.3 of [29].

## 2.5. Some notation

Throughout this paper we shall use the notation  $\sigma_\beta$  to denote a certain type of homeomorphism associated to a path  $\beta$  in  $\overline{\mathbb{C}}$ . If  $\beta : [0, 1] \rightarrow \overline{\mathbb{C}}$  is an arc, then  $\sigma_\beta$  is the identity outside a small disc neighborhood of  $\beta$ , and  $\sigma(\beta(0)) = \beta(1)$ . More generally, if  $*$  denotes the usual multiplication on paths, and  $\beta = \beta_1 * \cdots * \beta_r$  where each  $\beta_i$  is an arc, then

$$\sigma_\beta = \sigma_{\beta_r} \circ \cdots \circ \sigma_{\beta_1}.$$

This does not of course define  $\sigma_\beta$  pointwise, but if we take a sufficiently small neighborhood of  $\beta$ , then  $\sigma_\beta$  will be defined up to isotopy constant on any finite set which intersects  $\beta$  at most in the endpoints  $\beta(0)$ ,  $\beta(1)$ . In this paper  $\beta$  will always (as it turns out) be either an arc, or a simple closed loop, and we shall describe maps up to Thurston equivalence by compositions of the form  $\sigma_\beta \circ f$  for various  $\beta$  and various  $f$ .

Throughout this paper, if  $\beta : [a, b] \rightarrow \mathbb{C}$  is a path then  $\overline{\beta} : [a, b] \rightarrow \mathbb{C}$  is the reverse path defined by  $\overline{\beta}(t) = \beta(a + b - t)$ .

## 2.6. Captures and Matings

In this paper, a *capture* is a critically finite branched covering of a particular type, up to Thurston equivalence. This appears to be what is meant by “capture” in Wittner’s 1988 thesis [42]. Some authors take the word to mean any type III component, but the use made of the term in this paper coincides with the use made in [29, 30, 31], the reason being that captures in this sense are the most natural (type III) analogue of the matings which are also discussed by Wittner. These were introduced by Douady and Hubbard and have been very important examples since their introduction. Presumably because of the connection with the concept of mating, Wittner actually suggests the concept of capture is already known, but does not give any earlier written reference, and from recent conversation it seems likely that his thesis gives the first written reference to captures.

Let  $s = s_L$  be a lamination map which is Thurston equivalent to a polynomial preserving the corresponding invariant lamination  $L$ . The second critical point  $c_2(s)$  is fixed, coincides with  $v_2(s)$ , and is  $\infty$  in the standard model. Fix any gap  $G$  of  $L$  which contains some point  $x$  in the backward orbit of 0 under  $s$ . Then  $x$  is eventually periodic under  $s$ . Let  $\beta$  be an arc from  $c_2(s) = v_2(s)$  to  $x$  which crosses the unit circle exactly once, at a point of  $\partial G$ , such that, apart from this one point, all of  $\beta$  is in the union of  $G$  and  $\{z : |z| > 1\}$ . If  $x$  is periodic under  $s$  then let  $\zeta$  be the arc in  $s^{-1}(\beta)$

from  $c_2(s)$  to the periodic point in  $s^{-1}(x)$ . Then the associated capture, a critically finite branched covering defined up to Thurston equivalence, is

$$\sigma_\beta \circ s \text{ or } \sigma_\zeta^{-1} \circ \sigma_\beta \circ s$$

depending on whether  $x$  is strictly preperiodic or periodic under  $s$ . These can be distinguished as *type III captures* and *type II captures*.

The similar definition of a mating  $s_p \amalg s_q$  is defined for any odd denominator rationals  $p$  and  $q$ , and satisfies

$$s_p \amalg s_q(z) = \begin{cases} s_p(z) & \text{if } |z| \leq 1, \\ (s_q(z^{-1}))^{-1} & \text{if } |z| \geq 1. \end{cases}$$

A rational map which is Thurston equivalent to a mating  $s_p \amalg s_q$  must be the centre of a type IV hyperbolic component. So in this paper we concentrate on the captures.

There is a simple characterization of the captures which are Thurston equivalent to rational maps, which was proved by Tan Lei: see [38]. Actually that work concentrates on matings, but the modifications needed to consider captures are straightforward. The map  $\sigma_\beta \circ s$  (or  $\sigma_\zeta^{-1} \circ \sigma_\beta \circ s$  in the case of type II captures) is Thurston-equivalent to a rational map if and only if the  $S^1$ -crossing point of  $\beta$  is not strictly inside the smaller region of the circle bounded by  $\mu_0$ , where  $\mu_0$  is the minimal minor leaf with  $\mu_0 \leq \mu_L$ , and, if  $\beta$  crosses the circle precisely at an endpoint of  $\mu_0$ , then the second endpoint of  $\beta$  is not  $v_1$ . This last case, when the  $S^1$ -crossing point is an endpoint of  $\mu_0$ , perhaps needs a bit more adapting from Tan Lei's results than the others, but it is in fact a very special case, implying that  $\mu_0 = \mu_L$  and that the associated capture is a type II capture of a very special type. So these few cases can be dealt with separately and quite easily. A more general result was proved in the Non-Rational Lamination Map Theorem of [30].

In any case, the dynamics of a rational map equivalent to a capture defined by  $s = s_L$  and  $\beta$  is easily described in terms of the dynamics of  $s$ , and its Julia set is easily described in terms of  $L$ . The description is proved in a more general setting in the Lamination Map Conjugacy Theorem of [29]. We shall say that the hyperbolic component of a rational map which is a capture, up to Thurston equivalence is a *capture hyperbolic component*, or simply a capture.

## 2.7. Captures in $V_3$

As a consequence of Tan Lei's theorem, or a slight generalization of it, in the family  $V_3$ , there are three families of type III captures. The first is

$$\sigma_\beta \circ s_{1/7},$$

where  $\beta$  is any path with single  $S^1$ -crossing into a nonperiodic gap  $G$  in the full orbit of the critical gap of  $s_{1/7}$ , where  $G$  is in the larger region of the disc bounded by the minor leaf of  $L_{1/7}$ , which has endpoints at  $e^{2\pi i(1/7)}$  and  $e^{2\pi i(2/7)}$ . The second family is similar:

$$\sigma_\beta \circ s_{6/7},$$

where the single  $S^1$ -crossing by  $\beta$  is in the boundary of a preperiodic gap in the full orbit of the critical gap of  $L_{6/7}$ , in the larger region of the disc bounded by the minor leaf of  $L_{6/7}$ . The third family is

$$\sigma_\beta \circ s_{3/7},$$

where the single  $S^1$ -crossing by  $\beta$  is in the boundary of a preperiodic gap in the full orbit of the critical gap of  $L_{3/7}$ , in the larger region of the disc bounded by the leaf of  $L_{3/7}$  with endpoints at  $e^{2\pi i(1/3)}$  and  $e^{2\pi i(2/3)}$ . This time the boundaries of all gaps are disjoint, so one can describe  $\beta$  (up to homotopy keeping endpoints fixed) simply by its  $S^1$ -crossing. The  $S^1$ -crossing must be a nonperiodic point in the backward orbit under  $z \mapsto z^2$  of  $e^{2\pi i(2/7)}$  or  $e^{2\pi i(5/7)}$ , since every leaf in the boundary of a gap is in the backward orbit of the leaf with these endpoints in the boundary of the critical gap. If  $\beta$  has just one  $S^1$ -crossing at  $e^{2\pi ip}$ , we shall simply write  $\beta = \beta_p$  and  $\sigma_\beta = \sigma_{\beta_p} = \sigma_p$ . Strictly speaking, such maps are only equal up to a suitable homotopy, but this uniquely defines  $\sigma_p \circ s_{3/7}$  up to Thurston equivalence. It should be pointed out that this notation could be confusing, because it is somewhat at odds with the notation used for matings. The mating  $s_q \amalg s_p$  preserves the lamination  $L_q \cup L_p^{-1}$ , and the minor leaf of  $L_p^{-1}$  has an endpoint at  $e^{-2\pi ip}$ , not at  $e^{2\pi ip}$ . But the notation does seem rather natural and hopefully will not cause much confusion, since matings are somewhat in the background of this paper.

We shall use a similar notation for type II captures. If  $e^{2\pi ip}$  is periodic under  $z \mapsto z^2$ , and  $\beta_p$  is a capture path for  $s$ , where  $s = s_{3/7}$  or  $s_{1/7}$  or  $s_{6/7}$ , then we write  $\zeta_p$  for the path with periodic endpoint which is mapped homeomorphically to  $\beta_p$  by  $s$ , and define  $\sigma_p = \sigma_{\zeta_p}^{-1} \circ \sigma_{\beta_p}$ . Then  $\sigma_p \circ s$  is a type II capture.

## 2.8. Trivial Thurston equivalences between captures in $V_3$

It is in general a nontrivial question as to whether two captures,  $\sigma_\beta \circ s$  and  $\sigma_{\beta'} \circ s$  are Thurston equivalent. But there are some rather trivial equivalences within the families above which can be seen immediately. Suppose that  $\beta_1$  and  $\beta_2$  are two paths giving captures in the first family above, with  $\beta_1$  and  $\beta_2$  having the same endpoint  $x$ . Then  $\beta_1 * \bar{\beta}_2$  is a closed path which bounds a disc  $D$  disjoint from the forward orbit of  $x$ . It follows that  $\sigma_{\beta_1}$  and  $\sigma_{\beta_2}$  are isotopic via an isotopy constant on  $\{s_{1/7}^n x : n \geq 0\} \cup \{\infty\}$ , and hence

$$\sigma_{\beta_1} \circ s_{1/7} \simeq \sigma_{\beta_2} \circ s.$$



Thus, type III captures  $\sigma_\beta \circ s_{1/7}$  in the first family are uniquely determined, up to Thurston equivalence, by the second endpoint of  $\beta$ . In fact, the same is true for type II captures, by the same argument, because if we take two captures  $\sigma_{\zeta_1}^{-1} \circ \sigma_{\beta_1} \circ s$  and  $\sigma_{\zeta_2}^{-1} \circ \sigma_{\beta_2} \circ s$ , then the paths  $\zeta_1$  and  $\zeta_2$  are also homotopic via an isotopy constant on  $\{s_{1/7}^n x : n \geq 0\} \cup \{\infty\}$ , noting that in this case  $x$  is periodic and the common endpoint of  $\zeta_1$  and  $\zeta_2$  is in the periodic orbit of  $x$ . Exactly similar statements hold for the second family of type III captures  $\sigma_\beta \circ s_{6/7}$ , and for type II captures  $\sigma_\zeta^{-1} \circ \sigma_\beta \circ s_{6/7}$ .

It is not too hard to show directly that the Thurston equivalence classes in these two families are in one-to-one correspondence with the endpoints  $x(\beta)$  of the corresponding paths  $\beta$ . The idea is basically that if one takes the tree formed by joining points in the forward orbit of  $x(\beta)$  to the centres of adjacent triangle gaps, then the ambient isotopy class of this tree, with some vertices marked by a point in the forward orbit of  $x(\beta)$ , is fairly easily shown to be an invariant of the Thurston equivalence class, essentially because any Thurston equivalence between  $\sigma_\beta \circ s_q$ , for  $q = \frac{1}{7}$  or  $\frac{6}{7}$ , and the corresponding polynomial  $g$ , must isotope the tree to a tree joining up the full orbit of the finite critical point, which is entirely in the Fatou set, apart from common boundary points between Fatou components. We omit the details because the main theorems of this paper subsume this, and use different methods.

Somewhat more restricted statements are true for the third family of type III captures  $\sigma_\beta \circ s_{3/7}$ , and type II captures  $\sigma_\zeta^{-1} \circ \sigma_\beta \circ s_{3/7}$ . It is no longer generally true that  $\beta_1$  and  $\beta_2$  are homotopic via an isotopy constant on  $\{s_{3/7}^n x : n \geq 0\} \cup \{\infty\}$ , if  $\beta_1$  and  $\beta_2$  have the same endpoint  $x$ . But it is true if, in addition:

- the  $S^1$ -crossing points of  $\beta_1$  and  $\beta_2$  are both in the upper half-plane;
- or both in the lower half-plane;
- or both in the clockwise unit circle arc from  $e^{2\pi i(1/7)}$  to  $e^{2\pi i(6/7)}$ ;
- or both in the anticlockwise circle arc from  $e^{2\pi i(1/7)}$  to  $e^{2\pi i(2/7)}$ ;
- or both in the anticlockwise circle arc from  $e^{2\pi i(5/7)}$  to  $e^{2\pi i(6/7)}$ .

These all follow from a basic property of invariant laminations established by Thurston [39], that a leaf  $\ell'$  in the forward orbit of a leaf  $\ell$  can only be shorter than  $\ell$  if  $\ell$  is longer than the minor leaf. The minor leaf of  $L_{3/7}$  joins  $e^{2\pi i(3/7)}$  and  $e^{2\pi i(4/7)}$  and any leaf in the region bounded by  $\beta_1 * \overline{\beta_2}$ , under our hypotheses, has length less than this. So the disc bounded by  $\beta_1 * \overline{\beta_2}$  is again disjoint from the set  $\{s_{3/7}^n x : n \geq 0\} \cup \{\infty\}$ , and it is again true that  $\sigma_{\beta_1}$  and  $\sigma_{\beta_2}$  are isotopic via an isotopy constant on  $\{s_{3/7}^n x : n \geq 0\} \cup \{\infty\}$  and similarly for type II captures. So, this time, if we restrict to lamination maps which are Thurston equivalent to rational maps, there is at most one Thurston equivalence classes of type III captures  $\sigma_\beta \circ s_{3/7}$ , for each choice of endpoint of  $\beta$ , except when  $\beta$  ends at a gap  $G$  of  $L_{3/7}$ , in the smaller region of the disc bounded by the leaf with endpoints at  $e^{2\pi i(2/7)}$  and  $e^{2\pi i(5/7)}$  and the leaf with endpoints at

$e^{2\pi i(1/3)}$  and  $e^{2\pi i(2/3)}$ , and  $\partial G$  intersects the unit circle in both the upper and lower half plane. In this case, there are still at most two different Thurston equivalence classes, depending on whether the  $S^1$ -crossing of  $\beta$  is in the lower or upper half-plane. Similar statements hold for type II captures.

From the statements above it follows that any type II capture  $\sigma_\zeta^{-1} \circ \sigma_\beta \circ s_{3/7}$  must be Thurston equivalent to one where  $\beta$  has its only  $S^1$ -crossing at  $e^{2\pi i(2/7)}$ ,  $e^{2\pi i(5/7)}$  or  $e^{2\pi i(1/7)}$ . We shall see later, in 3.3, that there is a simple Thurston equivalence between the type II captures corresponding to  $S^1$ -crossings at  $e^{2\pi i(2/7)}$  and  $e^{2\pi i(5/7)}$ , where the homeomorphism  $\varphi$  realizing the equivalence fixes 0 and  $\infty$ .

The number of gaps of  $s_{3/7}$  in the full orbit of the critical gap and of preperiod  $n$  is  $2^n$ . The number of these in the large region of the disc bounded by the leaves with endpoints  $e^{\pm 2\pi i(1/3)}$  and  $e^{\pm 2\pi i(2/7)}$  is  $\frac{1}{21}2^n(1 + o(1))$ . A gap whose boundary intersects the circle in both upper and lower half-planes must have its entire forward orbit in between the leaves with endpoints at  $e^{\pm 2\pi i(3/7)}$  and  $e^{\pm 2\pi i(1/7)}$ . The number of such gaps whose boundaries intersect the unit circle in both the upper and lower half planes can be shown to be

$$\frac{1}{21} \cdot \left(\frac{3}{2}\right)^n + O(1).$$

This is  $o(2^n)$ . So, asymptotically, we can bound the number of captures up to Thurston equivalence by the number of endpoints of the paths  $\beta$ .

Regions of parameter space such as  $V_3(a_0)$  and  $V_3(\bar{a}_0)$ , that is, parts of quadratic rational parameter space with a natural association to some polynomial with star-like Julia set, were studied by the Hubbard school in the early 1990's. In particular, J. Luo [22] wrote his thesis on this subject, concentrating on the space  $V_2$ . He claimed a number of results, including the following: all type III and type IV hyperbolic components in  $V_2$  have centres which are Thurston equivalent to matings or captures. This is true, as is an analogue for  $V_3(a_0)$  and  $V_3(\bar{a}_0)$ . All type III hyperbolic components in  $V_3(a_0)$  or  $V_3(\bar{a}_0)$  have centres which are Thurston equivalent to captures  $\sigma_\beta \circ s_{1/7}$  or  $\sigma_\beta \circ s_{6/7}$ , and that all such captures are in this region, and similarly for type IV hyperbolic components in this region and matings. Luo formulated and stated much stronger results: an analogue, for  $V_2$ , of the Yoccoz puzzle and parapuzzle for quadratic polynomials [12], and associated results about local connectivity of Julia sets of nonrenormalisable polynomials, and uniqueness of quadratic rational maps for any specified nonrenormalisable combinatorics. The proofs in the thesis were not complete, although it seems very likely that they were completely known to the Hubbard school. But these, and similar results, have recently been reproved and written by Aspenberg and Yampolsky [1]. Another, different exposition is given by Timorin,

[40], which concentrates on the boundary of the type II hyperbolic component in  $V_2$ , where, rather surprisingly, only nonrenormalisable combinatorics occur.

As regards the simple result about all components in  $V_3(a_0)$  and  $V_3(\bar{a}_0)$  being represented by captures and matings, a simple analytical argument is available. (The argument in the case of  $V_2$ , as explained by Timorin [40], is even simpler.) Basically, the idea is to consider the point  $z_1(h)$  for all  $h$  in the region bounded by  $H_1$  and  $H_{-1}$ , where  $z_1(h)$  is the common boundary point of the three periodic attractive basins. It can be shown that  $z_1(h)$  exists throughout this region, essentially because the set where it exists is an open neighborhood of any point where  $z_1(h)$  is a repelling fixed point. So  $z_1(h)$  only disappears when one passes through a parabolic fixed point or if  $h \mapsto z_1(h)$  is a multivalued map, remembering that the set of fixed points of  $h$  is a multivalued map in general. But  $h \mapsto z_1(h)$  is single-valued in the region under consideration. Simple computer graphics do show clearly the rabbit-like connections between the different capture hyperbolic components in this part of parameter space, the part between  $H_1$  and  $H_{-1}$ . They also show the truncated Mandelbrot sets, each with a period three limb removed, one in the upper half-plane between  $H_{\pm 1}$  and the other in the lower half-plane.

Part of the statement of the main theorem (2.10, 6.1) is that all centres of type III hyperbolic components in  $V_3(a_1, -)$  are Thurston equivalent to captures  $\sigma_\beta \circ s_{3/7}$ , where  $\beta$  has  $S^1$ -crossing at  $e^{2\pi ip}$  with  $p \in (-\frac{1}{7}, \frac{1}{7})$ , and in fact one can restrict to  $p \in (0, \frac{1}{7})$ . I do not know a simple analytical argument, like the one above, to prove this, and, so far as I know, this result is new.

## 2.9. Symbolic Dynamics

Let  $p$  be an odd denominator rational. It is natural to make a Markov partition for the lamination map  $s_p$  using preperiodic leaves of  $L_p$  as boundaries of sets of the partition. In this paper, we are especially interested in doing this for  $p = \frac{1}{7}, \frac{3}{7}, \frac{6}{7}$ . For the case  $p = \frac{3}{7}$ , we look at the partition of  $\{z : |z| \leq 1\}$  by the leaves in  $L_{3/7}$  with endpoints at  $e^{2\pi ia}, e^{2\pi ib}$  where  $(a, b)$  is one of the following:

$$\left(\frac{2}{7}, \frac{5}{7}\right), \left(\frac{3}{7}, \frac{4}{7}\right), \left(\frac{1}{7}, \frac{6}{7}\right), \left(\frac{5}{14}, \frac{9}{14}\right), \left(\frac{3}{14}, \frac{11}{14}\right), \left(\frac{1}{14}, \frac{13}{14}\right).$$

In the case of  $p = \frac{1}{7}$  we take a similar partition where  $(a, b)$  is one of the following:

$$\left(\frac{1}{7}, \frac{2}{7}\right), \left(\frac{2}{7}, \frac{4}{7}\right), \left(\frac{4}{7}, \frac{1}{7}\right), \left(\frac{9}{14}, \frac{11}{14}\right), \left(\frac{11}{14}, \frac{1}{14}\right), \left(\frac{9}{14}, \frac{1}{14}\right).$$

The partition for  $s_{6/7}$  is obtained from this partition by conjugation. Here are the Markov partitions for  $s_{3/7}$  and  $s_{1/7}$ , with the different sets of the partition labelled. We use  $C$  for the ‘‘central’’ or ‘‘critical’’ region, which contains the critical gap of  $L_p$ .

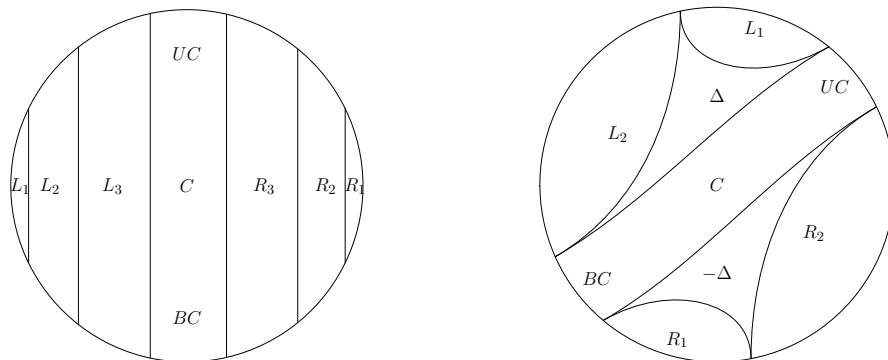
Symbolic dynamics for  $s_{3/7}$  and  $s_{1/7}$ 

We denote by  $BC$  and  $UC$  with intersection with the upper and lower half-planes respectively of the complement in  $C$  of the critical gap. Thus, the intersection of each of  $BC$  and  $UC$  with the open unit disc has countably many components. The letters  $B$  and  $U$  are for “below” and “upper”. The sets  $BC$  and  $UC$  are not part of the Markov partition, but nevertheless we can, and shall, use them in the symbolic dynamics. For  $s_{1/7}$  we also have triangular regions labelled  $\Delta$  and  $-\Delta$ . The labels  $L_j$  are for “left”, and  $R_j$  for “right”. This obviously makes more sense for  $s_{3/7}$ , when the sets certainly do run from left to right, than for  $s_{1/7}$ , when the “left” regions are on average only slightly left of the “right” regions, and more above than to the left of the “right” regions.

In the case of  $s_{3/7}$ , a more common partition might be that generated by the leaf  $\mu_{1/3}$  with endpoints  $e^{\pm 2\pi i(1/3)}$ . This translates to the Yoccoz partition for the polynomial which is Thurston equivalent to  $s_{3/7}$ . An important feature of the Yoccoz partition is that, although the partition varies with the polynomial, all the partitions for polynomials in a fixed limb have the same generator. Our choice of partition for  $s_{3/7}$  is made for similar reasons. The same generator gives a partition which is valid in part of parameter space. The part of parameter space which motivates the choice of partition is  $V_3(a_1)$ , rather than a limb of the Mandelbrot set. The leaf  $\mu_{3/7}$  with endpoints  $e^{\pm 2\pi i(3/7)}$  generates a smaller number of partitions than  $\mu_{1/3}$ , and is more closely adapted to  $V_3(a_1)$ .

The regions in the Markov partition for  $s_{3/7}$  are mapped as follows by  $s_{3/7}$ :

$$\begin{aligned} L_1, R_1 &\rightarrow R_1 \cup R_2, \\ L_2, R_2 &\rightarrow R_3 \cup C, \\ L_3, R_3 &\rightarrow L_2 \cup L_3, \\ C &\rightarrow L_1. \end{aligned}$$

The regions in the Markov partition for  $s_{1/7}$  are mapped as follows by  $s_{1/7}$ :

$$\begin{aligned} L_1, R_1 &\rightarrow L_2, \\ L_2, R_2 &\rightarrow R_1 \cup R_2 \cup -\Delta \cup C, \\ \Delta, -\Delta &\rightarrow \Delta. \end{aligned}$$

We now consider the case of  $L_{3/7}$  and  $s_{3/7}$ . Infinite words in the letters  $L_i, R_j$  and  $BC, UC, C$  label points of the circle, leaves of  $L_{3/7}$  and gaps of  $L_{3/7}$ . The labels determine gaps uniquely. Points and leaves also have unique labels except when they map forward to boundaries of sets in the Markov partition. Any gap of  $L_{3/7}$  is labelled by an infinite word which ends with the infinite word  $(CL_1R_2)^\infty$ . The preperiod of  $w$  is the length of  $w'$  where  $w = w'w''$  and either  $w'' = (CL_1R_2)^\infty$  with  $w'$  ending with  $L_2$ , or  $w'' = (R_2CL_1)^\infty$  with  $w'$  ending with  $R_1$ . Occurrences of  $BC$  or  $UC$  are allowed in  $w'$ , always followed by  $L_1$  and preceded by  $L_2$  or  $R_2$ . In fact, in  $w'$ , we never use the letter  $C$ , but always  $BC$  or  $UC$ , whichever is appropriate. A gap  $G$  of preperiod  $m$  contains a point  $x$  of  $Z_m(s_{3/7})$ , and is therefore labelled by the same word  $w(G) = w(x)$  as  $x$ . Points of  $Z_m(s)$  are uniquely determined by the prefix of  $w(x)$  of length  $m$ , which ends in  $R_1$  or  $L_2$ . In fact, we shall usually use the prefix of  $w(x)$  of length  $m + 2$  if the length  $m$  prefix ends in  $R_1$ , and of length  $m + 1$  if the length  $m$  prefix ends in  $L_2$ , so that points in  $Z_m(s)$ , and the gaps containing them, are represented by nonempty words ending in  $C$ . Thus, if  $x$  is of preperiod  $\geq 1$ ,  $w(x)$  ends in  $R_1R_2C$  or  $L_2C$ . The gaps between the leaves with endpoints  $(1/3, 2/3)$  and  $(2/7, 5/7)$  have words starting  $L_3^k L_2$  where  $k$  is odd. The gaps between the leaves with endpoints  $(2/7, 5/7)$  and  $(9/28, 19/28)$  have words starting  $L_3 L_2$ . Gaps which cross the real axis have words  $w'w''$ , where  $w'$  is the preperiodic part as above, with no occurrence of  $L_1$  in  $w'$ , equivalently no occurrence of  $C$  or  $R_1$  or  $R_2$  in  $w'$ .

In future, for a finite word  $w$ , we shall use the notation  $D(w)$  to denote the subset of the disc of points  $z$  labelled by  $w$ , that is with  $s^{i-1}(z) \in X_i$  if  $X_i$  is the  $i$ 'th letter of  $w$ . If  $w$  does not end with a string containing only the letters  $BC, UC, L_1$  and  $R_2$  then  $D(w)$  is bounded by one or two leaves of  $L_{3/7}$ . If  $w$  does end with such a string, then  $D(w)$  is a countable union of components of the complement of a gap.

## 2.10. The Main Theorem (first version)

We are now ready to state the first version of our main theorem. The description of  $V_{3,m}$  starts from the four subsets  $V_{3,m}(a_0)$ ,  $V_{3,m}(\overline{a_0})$  and  $V_{3,m}(a_1, \pm)$  defined in 2.2, together with the corresponding sets  $P_m(a_0)$ , and so on. The cases of  $V_{3,m}(a_0)$  and  $V_{3,m}(\overline{a_0})$  are described in item 1 below and  $V_{3,m}(a_1, -)$  in item 2. These descriptions are quite simple: all the type III hyperbolic components in these regions are captures, essentially described in exactly one way. The description for  $V_{3,m}(a_1, +)$  is not so

simple. The later versions of this theorem will be given in 5.7, 6.1 and 7.11. It is not claimed that the results about  $V_{3,m}(a_0)$  and  $V_{3,m}(\overline{a_0})$  are new, but the statement in the case of  $V_{3,m}(a_1, -)$  probably is.

We define

$$q_p = \frac{1}{3} - 2^{-p} \frac{1}{21},$$

so that  $q_0 = \frac{2}{7}$ ,  $q_1 = \frac{9}{28}$ , and so on. In terms of the symbolic dynamics introduced in 2.9, the code of the leaf of  $L_{3/7}$  with endpoints  $e^{2\pi i q_p}$  is  $L_3^{2p+1}(L_2 R_3 L_3)^\infty$ .

**Main Theorem (first version)** *There are injective maps*

$$a \mapsto \beta(a) : P_m(a_0) \rightarrow \pi_1(\overline{\mathbb{C}} \setminus Z_m(s_{1/7}), Z_m(s_{1/7}), v_2),$$

$$a \mapsto \beta(a) : P_m(\overline{a_0}) \rightarrow \pi_1(\overline{\mathbb{C}} \setminus Z_m(s_{6/7}), Z_m(s_{6/7}), v_2),$$

$$a \mapsto \beta(a) : P_m(a_1) \rightarrow \pi_1(\overline{\mathbb{C}} \setminus Z_m(s_{3/7}), Z_m(s_{3/7}), v_2),$$

such that  $h_a$  is Thurston equivalent to  $\sigma_{\beta(a)} \circ s$ , for  $s = s_{1/7}$ ,  $s_{6/7}$ ,  $s_{3/7}$  respectively. Moreover, we have the following additional information.

1. For  $a \in P_{3,m}(a_0)$ , the path  $\beta(a)$  is a capture path, intersecting  $S^1$  exactly once, in the boundary of the gap of  $L_{1/7}$  containing the endpoint of  $\beta$ , and the possible endpoints of such paths  $\beta$  are all points of  $Z_m(s)$  in the larger region of the unit disc bounded by the leaf with endpoints at  $e^{2\pi i(1/7)}$ ,  $e^{2\pi i(2/7)}$ . Thus  $h_a$  is Thurston equivalent to the capture  $\sigma_\beta \circ s_{1/7}$ . A similar statement holds with  $a_0$  replaced by  $\overline{a_0}$ , and with  $1/7$  and  $2/7$  replaced by  $6/7$  and  $5/7$ .
  2. For  $a \in P_{3,m}(a_1, -)$ , the path  $\beta(a)$  is again a capture path intersecting  $S^1$  exactly once, in the boundary of the gap of  $L_{3/7}$  containing the endpoint of  $\beta$ , and the possible endpoints of such paths  $\beta$  are all points of  $Z_m(s)$  in the smaller region of the unit disc bounded by the leaf with endpoints at  $e^{2\pi i(1/7)}$  and  $e^{2\pi i(6/7)}$ .
- In cases 1 and 2, the path  $\beta(a)$  is completely determined by its second endpoint. There is thus a natural one-to-one correspondence between the set  $P_m(a_0)$ ,  $P_m(\overline{a_0})$ ,  $P_m(a_1, -)$  and the set of points of  $Z_m(s)$  in the corresponding region of the dynamical plane of  $s$ , for  $s = s_{1/7}$ ,  $s_{6/7}$  and  $s_{3/7}$  respectively.
3. For  $a \in P_m(a_1, +)$ , the set of paths  $\beta(a)$  includes the capture paths crossing  $S^1$  at the points  $e^{\pm 2\pi i q_p}$  into the gap of preperiod  $2p$ . There is a bijection between  $P_{3,m}(a_1, +)$  and a set

$$\bigcup_{p=0}^{\infty} (U^p \cap Z_m) \times \{p\}.$$

Although the bijection does not send  $a$  to the endpoint of  $\beta(a)$ , the image of  $a$  under the bijection does determine the path  $\beta(a)$  algorithmically. The set  $U^p$  is

defined as follows:

$$U^0 = \begin{aligned} & D(L_3 L_2) \cup D(BC) \\ & \cup \bigcup_{k=1}^{\infty} (D(L_3^{3k+1} L_2) \cup D(L_3^{3k-1} L_2 BC)) \\ & \setminus (\bigcup_{k \geq 1} D(L_3 L_2 (UCL_1 R_2)^k BC)), \end{aligned}$$

and if  $p \geq 1$ , and  $S_{1,p,k}$  and  $S_{2,p,k}$  denote the local inverses corresponding to the words  $L_3^{2p+1+k(2p+3)}$  and  $L_3^{2p-1+k(2p+3)}$ , then

$$U^p = \begin{aligned} & \bigcup_{k=0}^{\infty} (S_{1,p,k} D(L_2) \cup \bigcup_{k=0}^{\infty} (S_{2,p,k} D(u_n) \cup (\bigcup_{1 \leq t \leq p} S_{2,p,k} D(v_{t,n})))) \\ & \cup \bigcup_{n=0}^{\infty} S_{1,p,k} D((L_2 R_3)^2 L_3^{2p-1} u_n) \\ & \setminus (\bigcup_{k=0}^{\infty} \bigcup_{n=0}^{\infty} (S_{1,p,k} D(u_n) \cup S_{2,p,k} D((L_2 R_3)^2 L_3^{2p-1} u_n) \cup \bigcup_{t=1}^p S_{1,p,k} D(v_{t,n}))), \end{aligned}$$

where  $v_{t,n} = L_2 (UCL_1 R_2)^n R_3 L_2 R_3 L_3^{2t-1} L_2$  and  $u_n = L_2 (UCL_1 R_2)^n BC$ .





## CHAPTER 3

### CAPTURES AND COUNTING

#### 3.1. Some nontrivial equivalences between captures

There is a more nontrivial Thurston equivalence between captures  $\sigma_\beta \circ s_{3/7}$  and a subset of the captures  $\sigma_{\beta'} \circ s_{1/7}$  which has, nevertheless, been known since the 1980's. Its mating analogue, known as “shared mating” is somewhat better known and plays a role in Adam Epstein's (unpublished) proof of noncontinuity of mating. These nontrivial equivalences arise from a rather simple fact: the existence of two isotopically distinct circles  $\gamma_1$  and  $\gamma_2$  such that  $\gamma_j = (s_{1/7} \amalg s_{3/7})^{-1}(\gamma_j)$ , for both  $j = 1, 2$ , modulo isotopy fixing  $X(s_{1/7} \amalg s_{3/7})$ .

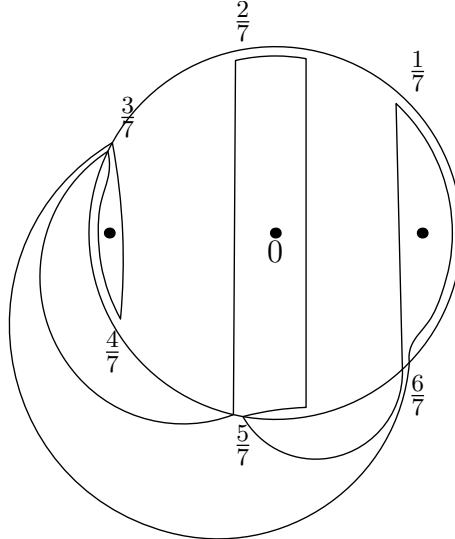

The two invariant circles

An isotopically invariant disc for a critically periodic branched covering  $f$  gives rise to a description of  $f$  as a mating up to Thurston equivalence. This is because we can then make a new branched covering, keeping  $f$  in the invariant disc and putting

a single fixed critical point in its complement. It can then be shown quite easily that there is no Thurston obstruction for this new branched covering, which is therefore, by Thurston's theorem, equivalent to a polynomial. Applying this argument to the invariant disc and its complement, which is also an invariant disc, we see that  $f$  is Thurston equivalent to a mating of the two polynomials.

Note that the two circles  $\gamma_1$  and  $\gamma_2$  intersect in an approximate triangle, but that the points of  $X(s_{1/7} \amalg s_{3/7})$  on the same side of  $\gamma_j$  as the triangle are different for  $\gamma_1, \gamma_2$ . We shall call this approximate triangle  $ET$ . It follows that

$$s_{3/7} \amalg s_{1/7} \simeq_{\varphi} s_{1/7} \amalg s_{3/7}$$

for a homeomorphism  $\varphi$  which maps the non-round circle  $\gamma_2$  to the round circle  $\gamma_1$  and maps  $Y_0(s_{3/7})$  to  $Y_0(s_{1/7})$ . This construction can be generalized. If we replace  $1/7$  by any odd denominator rational  $p$  with  $\mu_p \geq \mu_{1/7}$ , then, similarly to the above, we obtain an second non-round invariant circle for  $s_{3/7} \amalg s_p$  which separates the two periodic orbits, and hence gives rise to an equivalence

$$s_{3/7} \amalg s_p \simeq s_{1/7} \amalg s_q$$

for some  $q$ . This construction occurs in Wittner's thesis.

There is similar construction for captures. Take any type III capture  $\sigma_p \circ s_{3/7}$  for  $p \in (5/7, 6/7)$ . We are going to show that this is Thurston equivalent to a capture  $\sigma_q \circ s_{1/7}$  for some  $q$ . The idea is to find a tree which connects up the points of  $Z_n(s_{3/7})$ , if  $e^{2\pi ip}$  is in the boundary of a gap of  $L_{3/7}$  of preperiod  $n$ , and such that this tree is naturally isomorphic to the  $n$ 'th preimage of the Hubbard tree of  $s_{1/7}$ . Once we have this, the Thurston equivalence to a capture  $\sigma_q \circ s_{1/7}$  is automatic. Let  $T_0$  be the union of  $ET$  and the points of  $Y_0(s_{3/7})$ , joined to the triangle by arcs which do not intersect  $\gamma_2$ . Then  $T_0 \subset (\sigma_p \circ s_{3/7})^{-1}(T_0) = T_1$  up to isotopy preserving  $Y_1(s_{3/7})$ .

Let  $\Delta_0$  be a small tubular neighborhood in the unit disc of the triangular region  $\Delta$  which features in the symbolic dynamics for  $s_{1/7}$  in 2.9, so that  $Z_0(z_{1/7}) \cap \Delta_0 = \emptyset$ . Write  $\Delta_n = s_{1/7}^{-n}(\Delta_0)$ . Then there is a homeomorphism  $\varphi_1$  which maps  $T_1$  to a subset of the unit disc, consisting of  $\Delta_1$  and arcs joining the two components of  $\Delta_1$  to the five points of  $Y_1(s_{1/7})$ , and mapping  $Y_1(s_{3/7})$  to  $Y_1(s_{1/7})$ . Similarly, for each  $1 < m \leq n$ ,

$$T_0 \subset T_{m-1} \subset (\sigma_p \circ s_{3/7})^{-1}(T_{m-1}) = T_m \text{ rel } Y_m(s_{3/7}),$$

the set  $T_m$  is connected, and there is a homeomorphism  $\varphi_m$  mapping  $T_m$  to the union of  $\Delta_m$  and arcs joining up components of  $\Delta_m$  and points of  $Y_m(s_{1/7})$ . If we consider  $n + 1$ , we still have

$$T_n \subset T_{n+1} \text{ rel } Y_{n+1}(s_{3/7}),$$

and there is a homeomorphism  $\varphi_{n+1}$  such that

$$\varphi_{n+1}(T_n) = \varphi_n(T_n) \text{ rel } Y_n(s_{1/7}),$$

and

$$\varphi_{n+1}(T_n) \subset \varphi_{n+1}(T_{n+1}) \text{ rel } Y_n(s_{1/7}),$$

but, this time,  $\infty \in T_{n+1}$  and  $\infty \in \varphi_{n+1}(T_{n+1})$ . Then the component  $C$  of  $\varphi_{n+1}(T_{n+1} \setminus T_n)$  which contains  $\infty$  also contains exactly two points of  $Y_{n+1}(s_{1/7}) \setminus Y_n(s_{1/7})$ . If we join one of these points (it does not matter which) to  $\infty$  by an arc  $\zeta'$  in  $C$ , then  $\beta' = s_{1/7}(\zeta')$  joins  $\infty$  to a point of  $Z_n(s_{1/7})$ , and has only one  $S^1$ -crossing up to isotopy preserving  $Y_n(s_{1/7})$ , at some point  $e^{2\pi i q}$ . So  $\beta' = \beta_q$  is a capture path, and

$$\sigma_p \circ s_{3/7} \cong_{\varphi_n} \sigma_q \circ s_{1/7}.$$

Note that it is not stated that  $\beta_q = \varphi_n(\beta_p)$  up to isotopy preserving  $Y_n(s_{1/7})$ , and this is certainly not true in general. However, the proof above implies an algorithm for computing  $q$  from  $p$ . The tree  $T_n$  is defined using the map  $\sigma_p \circ s_{3/7}$ . We therefore sometimes use the more precise notation  $T_n(\sigma_p \circ s_{3/7})$  or  $T_n(p)$ . We also use  $T'_n(p)$  to denote the branches of  $T_n$  which connect  $ET$  to the forward orbit of  $e^{2\pi i p}$ , that is, the forward orbit of the gap with  $e^{2\pi i p}$  in its boundary, the gap containing the second critical value. The map  $\varphi_n$  also depends on  $p$ , and defines a correspondence between components of  $(\sigma_p \circ s_{3/7})^{-n}(ET)$  and components of  $s_{1/7}^{-n}(\Delta_0)$ . It also gives a correspondence between the gaps of  $L_{3/7}$  of preperiod  $n$  and the gaps of  $L_{1/7}$  of preperiod  $n$ , in the full orbit of the critical gap. So  $\varphi_n$  gives a relabelling of the gaps of  $L_{3/7}$ , in terms of the symbolic dynamics of  $s_{1/7}$ .

We start with an example of the smallest possible preperiod,  $\sigma_{23/28} \circ s_{3/7}$ , of preperiod two. Note that  $\frac{23}{28} \in (\frac{5}{7}, \frac{6}{7})$ , and that the forward orbit under  $x \mapsto 2x \bmod 1$  is given by

$$\frac{23}{28} \mapsto \frac{9}{14} \mapsto \frac{2}{7}.$$

With respect to the symbolic dynamics of  $s_{3/7}$ , the word of the gap with  $e^{2\pi i(23/28)}$  in its boundary is  $R_3L_2C$ . Now we need to compute the word of this gap with respect to the symbolic dynamics of  $s_{2/7}$ , using the tree  $T_2$  and homeomorphism  $\varphi_2$  constructed above. In the following array, each column indicates a path of gaps in the tree  $T_n$ , starting from the gap  $C$  at the bottom and working upwards. The word of each gap in a column is obtained by reading the word starting from that letter in the column, and including all letters to the right of it. We are using the convention introduced in 2.9, which allows us to use finite words to represent gaps of  $L_{3/7}$ . The first row is the word of the gap containing  $e^{2\pi i p}$  in its boundary. The  $\uparrow$  symbol indicates a connection across a component of  $(\sigma_p \circ s_{3/7})^{-n}(ET)$ . The gaps in each column are the inverse images under  $s_{3/7}$  (and also under  $\sigma_p \circ s_{3/7}$ ) of the gaps to the right. The last two rows indicate symbolic dynamics for  $s_{1/7}$ . The last is a refined lettering of the last-but-one. The last-but-one row of letters  $L, R, BC$  and  $UC$  is obtained from the last connection in the row above. The letter  $L$  is chosen when the letters above

are  $C$  with  $R_2$  or  $L_1$  above this, and  $R$  is chosen if the letter  $C$  above has  $L_2$  or  $R_1$  immediately above it. The letters  $BC$  and  $UC$  do not occur in this first example, but when they do, they are given by  $BC$  and  $UC$  respectively in the row above. This can be seen to be correct by examining the initial picture of the two invariant circles  $\gamma_1$  and  $\gamma_2$  for  $s_{3/7} \amalg s_{1/7}$ .

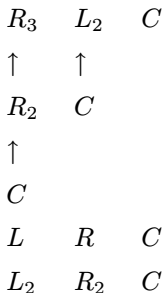

This gives

$$\sigma_{23/28} \circ s_{3/7} \simeq s_{\beta'} \circ s_{1/7}$$

where the gap containing the endpoint of  $\beta'$  is encoded by  $L_2R_2C$ , using the symbolic dynamics of 2.9 for  $s_{1/7}$ .

A capture  $\sigma_p \circ s_{3/7}$  with  $p \in (\frac{5}{7}, \frac{6}{7})$  must end in a gap whose word in the symbolic dynamics for  $s_{3/7}$  starts with the letter  $R_3$  or  $BC$ . Now we consider a capture path with endpoint in a gap whose word in the symbolic dynamics of  $s_{3/7}$  starts with  $BC$ . The shortest possible word is  $BCL_1R_1R_2C$ . The gap has  $e^{2\pi i(41/56)}$  in its boundary. The other end of the leaf in the gap boundary is at  $e^{2\pi i(43/56)}$ . The gap has preperiod 3. The computation is as follows.

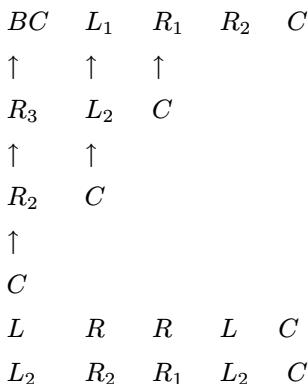

So

$$\sigma_{41/56} \circ s_{3/7} \simeq \sigma_{\beta'} \circ s_{1/7}$$

where the gap of  $L_{1/7}$  containing the second endpoint of  $\beta'$  is encoded by  $L_2R_2R_1L_2C$ .

We next consider an example chosen at random. Take  $\sigma_p \circ s_{3/7}$  with  $p \in (\frac{5}{7}, \frac{6}{7})$  with endpoint coded, with respect to the symbolic dynamics for  $s_{3/7}$ , by  $w(\beta, \frac{3}{7}) = R_3L_3L_2R_3L_2C$ . The computation then uses the following array.

$R_3$	$L_3$	$L_2$	$R_3$	$L_2$	$C$
$\uparrow$ top	$\uparrow$ top	$\uparrow$ bot	$\uparrow$ top	$\uparrow$ top	
$R_2$	$UC$	$L_1$	$R_2$	$C$	
$\uparrow$	$\uparrow$	$\uparrow$	$\uparrow$		
$C$	$C$	$C$	$C$		
$L$	$UC$	$L$	$L$	$R$	$C$
$L_2$	$UC$	$L_1$	$L_2$	$R_2$	$C$

So

$$\sigma_{127/224} \circ s_{1/7} \simeq \sigma_{\beta'} \circ s_{3/7},$$

where the gap of  $L_{1/7}$  containing the second endpoint of  $\beta'$  is encoded by  $L_2UCL_1L_2R_2C$ .

These calculations are fairly routine, and can easily be automated. They are perhaps not, however, quite as simple as they seem. In the examples above,  $T'_n(p)$  coincides with path of  $T_n(s_{3/7} \amalg s_{1/7})$ , the tree used to compute the periodic-orbit-exchanging self-Thurston equivalence of  $s_{3/7} \amalg s_{1/7}$  up to isotopy preserving the  $n$ 'th preimages of periodic orbits. But  $T'_n(p)$  does not always so coincide. A relatively small example of preperiod 8 is given by the gap with word  $R_3L_3^3L_2R_3L_3L_2C$ . There is at least one point  $e^{2\pi ip}$  in the boundary of this gap with  $p \in (\frac{5}{7}, \frac{6}{7})$ . This gap is between the gaps with words  $R_3L_3L_2C$  and  $R_3L_2C$ . It follows that the component  $E'$  of  $(\sigma_p \circ s_{3/7})^{-3}(ET)$  which joins the gaps with words  $R_3L_3L_2C$  and  $R_3L_2C$  separates  $e_{2\pi ip}$  from  $\infty$  in  $\{z : |z| \geq 1\}$ . Then  $(\sigma_p \circ s_{3/7})^{-1}(E')$  consists of two long thin triangles, which are not simply tubular neighborhoods of triangles of  $L_{1/7}^{-1}$ , as was the case with all previous examples. These triangles are intersected by  $T'_4(p)$ . It follows that  $T'_4(p)$  is not contained in  $T_4(s_{3/7} \amalg s_{1/7})$  up to isotopy, and a fortiori  $T'_8(p)$  is not contained in  $T_8(s_{3/7} \amalg s_{1/7})$ .

In summary, every type III capture  $\sigma_p \circ s_{3/7}$  with  $p \in (\frac{5}{7}, \frac{6}{7})$  is Thurston equivalent to a type III capture  $\sigma_{\beta'} \circ s_{1/7}$ , which can be algorithmically computed. Similarly, every type III capture  $\sigma_p \circ s_{3/7}$  with  $p \in (\frac{1}{7}, \frac{2}{7})$  is Thurston equivalent to a type III capture  $\sigma_{\beta'} \circ s_{5/7}$ . So we have the following.

**THEOREM 3.2.** – *Every type III capture in  $V_3$  is Thurston equivalent to one of the form  $\sigma_\beta \circ s_q$ , where  $\beta$  has second endpoint  $x \in s_q^{-n}(\{s_q^j(0) : j = 0, 1, 2\})$ , for some*

least  $n > 0$ , and the gap containing  $x$  has longest leaf with endpoint at  $e^{2\pi ip}$ , where  $e^{2\pi ip}$  is the  $S^1$ -crossing of  $\beta$  and one of the following holds:

- $q = \frac{1}{7}$ ,  $p \in (\frac{2}{7}, \frac{8}{7})$ ;
- $q = \frac{6}{7}$ ,  $p \in (\frac{-1}{7}, \frac{5}{7})$ ;
- $q = \frac{3}{7}$ ,  $p \in (\frac{2}{7}, \frac{1}{3}) \cup (\frac{2}{3}, \frac{5}{7}) \cup (-\frac{1}{7}, \frac{1}{7})$ .

In the cases  $q = \frac{1}{7}$  and  $\frac{6}{7}$ , and  $q = \frac{3}{7}$  with  $p \in (-\frac{1}{7}, \frac{1}{7})$ , we only need to include one path  $\beta$  for each  $x$ . In the case of  $q = \frac{3}{7}$  with  $p \in (\frac{2}{7}, \frac{1}{3}) \cup (\frac{2}{3}, \frac{5}{7})$  we also need to include at most one path, except in the case when the boundary of the gap containing  $x$  intersects both the upper and lower halves of the unit circle, when we only need to include one path crossing the upper half circle and one crossing the lower half circle into the gap containing  $x$ .

In the cases  $q = \frac{1}{7}$  and  $\frac{6}{7}$ , this theorem is subsumed in the statement of the main theorem in 2.10.

### 3.3. Equivalences between captures $\sigma_p \circ s_{3/7}$ , for $p \in (\frac{2}{7}, \frac{1}{3}) \cup (\frac{2}{3}, \frac{5}{7})$

First we simplify the notation. We write  $L$  for invariant lamination  $L_{3/7}$  and  $s = s_{3/7}$ . Note that the only gaps of  $L$  lie in the full orbit of the critical gap. We also write  $\sigma_q$  for  $\sigma_{\beta_q}$  (as in 2.7) or  $\sigma_{\zeta_q}^{-1} \circ \sigma_{\beta_q}$  if  $\beta_q$  is a path which crosses the unit circle at the point  $e^{2\pi iq}$  into a gap  $G$  of  $L$ , with all of the path being in  $G \cup \{z : |z| > 1\}$  apart from the point  $e^{2\pi iq}$ . Here, we use  $\sigma_{\zeta_q}$  if and only if  $G$  is in the periodic orbit of the critical gap, in which case  $\zeta_q$  is the path in  $s^{-1}(\beta_q)$  mapping homeomorphically under  $s$  and the endpoint of  $\zeta$  is in the periodic component of  $s^{-1}(G)$ . We are interested only in captures for  $q \in [2/7, 1/3) \cup (2/3, 5/7]$ . Then we have

$$\sigma_{5/7} \circ s \simeq \sigma_{2/7} \circ s,$$

and, for any  $k \geq 1$ ,

$$\sigma_{1-q_k} \circ s \simeq \sigma_{q_k} \circ s,$$

where

$$q_k = \frac{1}{3} - 2^{-2k} \frac{1}{21}.$$

These equivalences are obtained as follows. Let  $D_q$  be the disc whose boundary intersects the unit circle only at the points  $e^{\pm 2\pi iq}$  and running along the lamination leaf in the unit disc between these points, which contains the smaller segment of the unit disc cut off by this leaf, but which is also taken to include  $v_2 = c_2 = s(c_2) = \infty$  in its interior. Let  $\alpha = \alpha_q$  be the clockwise loop in  $D = D_q$  based at  $v_2$  crossing  $S^1$  only at the points  $e^{\pm 2\pi iq}$ , running along the lamination leaf between them. Thus,  $\alpha_q$

is homotopic to an arbitrarily small perturbation of  $\beta_q * \overline{\beta_{1-q}}$ . First we claim that for any  $q$ ,

$$(3.3.1) \quad (\sigma_{q_p} \circ s, Y_0(s)) \simeq_{\text{identity}} (\sigma_{1-q_p} \circ s, Y_0(s)).$$

We see this as follows. The disc  $D' = \overline{\mathbb{C}} \setminus \text{int}(D)$  contains no critical values. So

$$s^{-1}(D') = D_+ \cup D_-$$

has two components, homeomorphic preimages under  $s$  of  $D'$ , where  $D_+ = D_{+,q}$  contains  $v_1$  and  $D_- = D_{-,q}$  contains  $s(v_1)$ . These discs are peripheral in  $Y_0(s)$ . So Dehn twists round their boundaries are trivial up to isotopy preserving  $Y_0(s)$ . A clockwise Dehn twist round a simple closed loop  $\gamma$  on an orientable surface  $S$  means a homeomorphism up to isotopy which can be chosen to be the identity outside an arbitrarily small annulus neighborhood of  $\gamma$ , and twists one boundary component  $\gamma_1$  of the annulus clockwise relative to the other one,  $\gamma_2$ . Since the annulus inherits an orientation from  $S$ , a clockwise twist of  $\gamma_1$  relative to  $\gamma_2$  is the same as a clockwise twist of  $\gamma_2$  relative to  $\gamma_1$ . Note that  $\partial D = \partial D'$ . So (anti)clockwise Dehn twist round  $\partial D$  is the same as (anti)clockwise Dehn twist round  $\partial D'$ . Now  $\sigma_\alpha$  is isotopic to a composition of clockwise Dehn twist round  $\partial D$  and anticlockwise Dehn twist round the boundary of a disc strictly inside  $\alpha$ . Since this inner disc is peripheral, we obtain

$$(3.3.2) \quad (\sigma_\alpha \circ s, Y_0(s)) \simeq_{\text{identity}} (s, Y_0(s)).$$

In the case when  $q = q_0 = \frac{2}{7}$ , since  $\alpha$  is a perturbation of  $\beta_{2/7} * \overline{\beta_{5/7}}$ , and since  $\zeta_{2/7}$  and  $\zeta_{5/7}$  are homotopic via a homotopy preserving  $Y_0(s)$ , we have, composing on the left with  $\sigma_{\zeta_{2/7}}^{-1} \circ \sigma_{\beta_{5/7}}$ ,

$$\begin{aligned} (\sigma_{2/7} \circ s, Y_0(s)) &= (\sigma_{\zeta_{2/7}}^{-1} \circ \sigma_{\beta_{2/7}} \circ s, Y_0(s)) \simeq_{\text{identity}} (\sigma_{\zeta_{2/7}}^{-1} \circ \sigma_{\beta_{5/7}} \circ s, Y_0(s)) \\ &\simeq_{\text{identity}} (\sigma_{\zeta_{5/7}}^{-1} \circ \sigma_{\beta_{5/7}} \circ s, Y_0(s)) = (\sigma_{5/7} \circ s, Y_0(s)). \end{aligned}$$

So this gives (3.3.1) in the case  $q = q_0$ . For any  $k > 0$ , and  $q = q_k$ , the disc inside  $\beta_q * \overline{\beta_{1-q}}$  and  $D_{-,q}$ , are both disjoint from the forward orbit of the second endpoint of  $\beta_{q_k}$ . So in these cases also, composing (3.3.2) on the left with  $\sigma_{\beta_{1-q}}$  gives (3.3.1)

We can express (3.3.2) more accurately. We write  $\psi_{0,q}$  for the anticlockwise twist round the boundary of a disc which is strictly inside  $\alpha_q$ , but with boundary arbitrarily close to  $\alpha_q$ . Then  $\psi_{0,q}$  commutes with  $\sigma_{\alpha_q}$ . Also,  $\sigma_{\alpha_q}^{-1} \circ \psi_{0,q}$  is isotopic, relative to  $Y_n(s)$  for any  $n$ , to the anticlockwise Dehn twist round  $\partial D = \partial D_q$ , which as already mentioned, is isotopic to the anticlockwise Dehn twist round  $\partial D'$ . Let  $\xi_{0,q}$  denote the anticlockwise Dehn twist round  $\partial D_-$ . Note that  $D_{-,q}$  is peripheral in  $Y_0(s)$ , but not in  $Y_1(s)$ , and  $D_{+,q}$  and  $D$  are isotopic in  $\overline{\mathbb{C}} \setminus Y_1(s)$ , in fact in  $\overline{\mathbb{C}} \setminus Y_{2k+1}(s)$  if  $q = q_k$  – but not in  $\overline{\mathbb{C}} \setminus Y_{2k+2}(s)$ . So  $\xi_{0,q}$  is isotopic to the identity relative to  $Y_0(s)$ , and

$$\psi_{0,q} \circ s = \sigma_{\alpha_q} \circ s \circ \psi_{0,q} \circ \xi_{0,q} \text{ rel } Y_1(s).$$

For any  $q = q_k$ , write

$$\psi_{1,q} = \xi_{0,q} \circ \psi_{0,q} = \psi_{0,q} \circ \xi_{0,q}.$$

Then we have

$$(s, Y_1(s)) \simeq_{\psi_{1,q}} (\sigma_\alpha \circ s, Y_1(s)).$$

For  $m < 2k + 1$ , we then define  $\xi_{m,q}$  inductively by

$$(3.3.3) \quad s \circ \xi_{m,q} = \xi_{m-1,q} \circ s,$$

choosing the lift  $\xi_{m,q}$  of  $\xi_{m-1,q}$  which is isotopic to the identity relative to  $Y_m(s)$ . This is possible inductively, because  $\xi_{0,q}$  is isotopic to the identity relative to  $Y_0(s)$ : we just lift this isotopy. Then we define  $\psi_{m+1,q}$  inductively by

$$\psi_{m+1,q} = \xi_{m,q} \circ \psi_{m,q}.$$

It is then true, for  $m \leq 2k + 1$ , that

$$(3.3.4) \quad \psi_{m,q} \circ s = \sigma_{\alpha_q} \circ s \circ \psi_{m+1,q} \text{ rel } Y_{m+1}(s).$$

For  $m = 2k$ , since the support of  $\psi_{2k}$  is disjoint from  $\beta_{1-q_k}$ , we obtain, by composing on the left with  $\sigma_{1-q_k}^{-1}$ , for  $q = q_k$ ,

$$(3.3.5) \quad \sigma_{1-q} \circ s \simeq_{\psi_{2k,q}} \sigma_q \circ s.$$

For  $m = 2k + 1$  and  $q = q_k$ , we define  $\xi_{2k+1,q}$  slightly differently. Write

$$A_q = A_{2k+1,q} = D_q \setminus D_{+,q}.$$

The index  $2k + 1$  is chosen because  $A_{2k+1,q}$  is disjoint from  $Y_{2k+1}(s)$ . Let  $\xi_{2k+1,1,q}$  denote the clockwise twist of the annulus  $A_{2k+1,q_k}$  relative to  $\overline{C} \setminus A_{2k+1,q}$ . Then we define  $\xi_{2k+1,q}$  by

$$\xi_{2k,q} \circ s \circ \xi_{2k+1,1,q} = s \circ \xi_{2k+1,q}$$

and  $\xi_{2k+1,q}$  is isotopic to the identity relative to  $Y_{2k+1,q_k}$ . Hence, (3.3.4) holds for  $m = 2k + 1$ , and this yields

$$\psi_{2k+2,q} \circ s = \sigma_{\alpha_q} \circ s \circ \psi_{2k+2,q} \text{ rel } Y_{2k+2}(s).$$

Composing on the right with  $\psi_{2k+2,q}^{-1}$ , this gives

$$(3.3.6) \quad (s, Y_{2k+2}(s)) \simeq_{\psi_{2k+2,q}} (\sigma_\alpha \circ s, Y_{2k+2}(s)).$$

The support of  $\xi_{m,q}$  is as follows, up to isotopy preserving  $Y_m(s)$ . Let  $C_q = C_{0,q}$  be the annulus which is the complement, in  $D_-(q)$ , of a small neighborhood of  $s(v_1)$ . For  $m \leq 2k + 1$ , define

$$C_{m,q} = s^{-m}(C_q).$$

Note that  $C_{m,q}$  is disjoint from  $Y_m(s)$  for all  $m$ , and, for  $m \leq 2k + 1$ ,  $C_{m,q}$  is disjoint from  $\alpha_q$ . For  $m < 2k + 1$ , the support of  $\xi_{m,q}$  is  $C_{m,q}$ , up to isotopy. The support of  $\xi_{2k+1,q}$  is  $C_{2k+1,q} \cup A_{2k+1,q}$ , again up to isotopy.



It is also interesting to compare  $\psi_{2k+2,q_k}$  and  $\psi_{2k+2,q_{k+1}}$ . Note that

$$D_{q_k} = A_{q_k} \cup D_{q_{k+1}}.$$

The overlap between  $A_{q_k}$  and  $D_{q_{k+1}}$  is trivial in  $Y_{2k+2}$ . Therefore

$$(3.3.7) \quad \psi_{0,q_{k+1}} = \xi_{2k+2,2,q_k} \circ \psi_{0,q_k},$$

where the support of  $\xi_{2k+2,2,q_k}$  is strictly smaller than the support  $A_{q_k}$  of  $\xi_{2k+1,1,q_k}$ , and is trivial in  $Y_{2k+2}$ . So

$$[\psi_{0,q_{k+1}}] = [\psi_{0,q_k}] \text{ in } \text{MG}(\overline{\mathbb{C}}, Y_{2k+2}(s)).$$

Also, for  $m \leq 2k$ ,

$$\xi_{m,q_k} = \xi_{m,q_{k+1}} \text{ rel } Y_{2k+2}(s).$$

and

$$\xi_{2k+1,q_k} \circ \xi_{2k+1,1,q_k}^{-1} = \xi_{2k+1,q_{k+1}} \text{ rel } Y_{2k+2}(s).$$

So, for  $m \leq 2k + 2$ ,

$$(3.3.8) \quad [\psi_{m,q_{k+1}}] = [\psi_{m,q_k}] \text{ in } \text{MG}(\overline{\mathbb{C}}, Y_{2k+2}(s)).$$

In particular, using this for  $m = 2k + 2$ ,  $q = q_k$  and  $r = q_{k+1}$ , we have, from (3.3.5) for  $r$  replacing  $q$ ,

$$(3.3.9) \quad \sigma_{1-r} \circ s \simeq_{\psi_{2k+2,q}} \sigma_r \circ s.$$

We can generalize to some other  $q$ , as follows. Let  $G$  be the gap containing the endpoint of  $\beta_q$ . Suppose that the word  $w$  for  $G$  (see 2.9) starts  $L_3^{2k+1}L_2$  for some integer  $k \geq 0$ , and has no other occurrence of  $L_3^{2k+1}$ , and no occurrence of  $BC$  or  $UC$  before the final  $C$ . Then (3.3.3), (3.3.4) hold for all  $m$  less than the preperiod of the endpoint of  $\beta_q$  (equivalently of  $e^{2\pi i q}$ ), and (3.3.4) also holds when  $m$  is this preperiod, and (3.3.6) holds with  $2k + 2$  replaced by this preperiod.

### 3.4. Numbers of type III components

In this section, for each  $m$ , we calculate the number of type III components of preperiod  $m$  and, and give an upper bound on the number of captures of preperiod  $m$  in  $V_3 = \{h_a : a \in \mathbb{C}\}$ . One basic point of interest is that the second number is less than the first, for all  $m \geq 3$ , and asymptotically the proportion of preperiod  $m$  hyperbolic components which are captures is strictly less than 1. The exact proportion is an open question, as it seems to be a hard problem to identify all Thurston equivalences between captures. Anyway, these calculations give a useful check on the validity of Theorem 2.10. Each type III component in  $V_3$  has a unique centre  $h_a \in P_{3,m} \setminus P_{3,m-1}$  for which the second critical value

$$v_2(h_a) = \frac{-(a-1)^2}{4a} \in Z_m(h_a) \setminus Z_{m-1}(h_a) = h_a^{-(m-1)}(h_a^{-1}(Z_0(a)) \setminus Z_0(a)),$$

where  $Z_0(h_a) = \{0, 1, \infty\}$ , for all  $a \in \mathbb{C} \setminus \{0\}$ , for a unique integer  $m > 0$ . We then have  $h_a^m(v_2) = 0$  or  $1$ , and we write  $P'_m(0)$  or  $P'_m(1)$  for the corresponding sets of punctures, so that

$$P_{3,m} \setminus P_{3,m-1} = P'_m(0) \cup P'_m(1).$$

Now

$$h_a^{-1}(\{0\}) = \{1, a\}, \quad h_a^{-1}(\{1\}) = \left\{ \infty, \frac{a}{a+1} \right\}.$$

So

$$P'_m(0) = \left\{ a : h_a^{m-1} \left( \frac{-(a-1)^2}{4a} \right) - a = 0, a \neq 0, 1 \right\},$$

$$P'_m(1) = \left\{ a : h_a^{m-1} \left( \frac{-(a-1)^2}{4a} \right) - \frac{a}{a+1} = 0, a \neq 0, -1 \right\}.$$

So each of  $P'_m(0)$  and  $P'_m(1)$  is a zero set of a polynomial, and  $\#(P'_m(0))$ ,  $\#(P'_m(1))$  are the respective degrees of these polynomials, if all zeros of the polynomials are simple. In fact, the zeros are necessarily simple, as pointed out to me by Jan Kiwi. Intersections between  $V_3$  and

$$W = \{f_{c,d} : f_{c,d}^m(v_2) = c_1\}$$

are transversal and similarly for  $c_1$  replaced by  $f_{c,d}(v_1)$ . Given an intersection point between  $W$  and  $V_3$ , a transversal  $F : \{\lambda : |\lambda| < 1\} \rightarrow W$  can be constructed so that  $F(0)$  is the intersection point, and the multiplier of a period 3 point of  $F(\lambda)$  is  $\lambda$ . We omit the details, but this is a standard technique which uses the Measurable Riemann Mapping Theorem, and used by Douady and Hubbard, for example. The polynomials are divisors of, respectively,

$$p_m(a) - aq_m(a), \quad (a+1)p_m(a) - aq_m(a),$$

where

$$h_a^m \left( \frac{2a}{a+1} \right) = \frac{p_m(a)}{q_m(a)},$$

and  $p_m$  and  $q_m$  have no common factors. Note that if  $a = 0$  or  $1$ , then  $a = \frac{2a}{a+1}$ , so that  $h_a^m \left( \frac{2a}{a+1} \right) = a$  whenever  $m$  is divisible by 3. Similarly if  $a = 0$  or  $-1$  then  $\frac{a}{a+1} = \frac{2a}{a+1}$ , so that  $h_a^{m-1} \left( \frac{-(a-1)^2}{4a} \right) = \frac{a}{a+1}$  whenever  $m$  is divisible by 3. So  $\#(P'_m(0))$ ,  $\#(P'_m(1))$  are the respective degrees of these polynomials when  $m$  is not divisible by 3, and the respective degrees minus 2 if  $m$  is divisible by 3. Now if  $a$  is not a factor of  $p_m$ , we have

$$p_{m+1}(a) = (p_m(a))^2 - (a+1)p_m(a)q_m(a) + a(q_m(a))^2,$$

$$q_{m+1}(a) = (p_m(a))^2.$$

If  $a$  is a factor of  $p_m$ , then the only possible common factor of the two polynomial expressions above is  $a$ , and so these expressions give  $ap_m(a)$  and  $aq_m(a)$ . Note that  $a|p_0$ , or  $p_0 = 0 \pmod{a}$ . A simple induction shows that if  $p_m = 0 \pmod{a}$  then  $q_{m+1} = 0 \pmod{a}$ ,  $p_{m+2} = q_{m+2} \pmod{a}$  and  $p_{m+3} = 0 \pmod{a}$ . So  $a$  is a factor of  $p_m$  if and only if  $3|m$ . Let  $c_m, d_m$  be the coefficients of the highest order terms of  $p_m$  and  $q_m$  respectively. For all  $m$ , we trivially have

$$d_{m+1} = c_m^2 > 0.$$

Then a simple induction shows that

$$\begin{aligned} \deg(p_m) = \deg(q_m), & \quad 0 < 2d_m \leq c_m, & \quad c_{m+1} = d_m^2 - c_m d_m & \quad \text{if } m \text{ is even,} \\ \deg(p_m) = \deg(q_m) + 1, & \quad -d_m < c_m < 0, & \quad c_{m+1} = c_m^2 - c_m d_m & \quad \text{if } m \text{ is odd.} \end{aligned}$$

Let  $a_m = \deg(p_m)$ . Then we have

$$a_{m+1} = \begin{cases} 2a_m & \text{if } m = 0, 1, 5 \pmod{6}, \\ 2a_m - 1 & \text{if } m = 3 \pmod{6}, \\ 2a_m + 1 & \text{if } m = 2, 4 \pmod{6}. \end{cases}$$

Then

$$\begin{aligned} a_{6k+6} &= 2a_{6k+5} = 4a_{6k+4} + 2 = 8a_{6k+3} - 2 = 16a_{6k+2} + 6 = 64a_{6k} + 6 \\ &= 2^{6k+6} \left( 1 + \frac{2}{21} \right) - \frac{2}{21}. \end{aligned}$$

So for all  $m$ ,

$$a_m = 2^m \left( 1 + \frac{2}{21} \right) + O(1).$$

More precisely,

$$a_m = 2^m \left( 1 + \frac{2}{21} \right) \begin{cases} -\frac{2}{21} & \text{if } m = 0 \pmod{6}, \\ -\frac{4}{21} & \text{if } m = 1 \pmod{6}, \\ -\frac{8}{21} & \text{if } m = 2 \pmod{6}, \\ +\frac{5}{21} & \text{if } m = 3 \pmod{6}, \\ -\frac{11}{21} & \text{if } m = 4 \pmod{6}, \\ -\frac{1}{21} & \text{if } m = 5 \pmod{6}. \end{cases}$$

For example:

$$a_1 = 2, a_2 = 4, a_3 = 9, a_4 = 17, a_5 = 35, a_6 = 70 \dots$$

We also have

$$\deg(p_m(a) - aq_m(a)) = \begin{cases} a_m + 1 & \text{if } m \text{ is even,} \\ a_m & \text{if } m \text{ is odd.} \end{cases}$$

So

$$(3.4.1) \quad \#(P'_m(1)) = 2^m \left(1 + \frac{2}{21}\right) \begin{cases} -\frac{23}{21} & \text{if } m = 0 \pmod{6}, \\ +\frac{17}{21} & \text{if } m = 1 \pmod{6}, \\ +\frac{13}{21} & \text{if } m = 2 \pmod{6}, \\ -\frac{16}{21} & \text{if } m = 3 \pmod{6}, \\ +\frac{10}{21} & \text{if } m = 4 \pmod{6}, \\ +\frac{20}{21} & \text{if } m = 5 \pmod{6}. \end{cases}$$

Similarly,

$$(3.4.2) \quad \#(P'_m(0)) = 2^m \left(1 + \frac{2}{21}\right) \begin{cases} -\frac{23}{21} & \text{if } m = 0 \pmod{6}, \\ -\frac{4}{21} & \text{if } m = 1 \pmod{6}, \\ +\frac{13}{21} & \text{if } m = 2 \pmod{6}, \\ -\frac{37}{21} & \text{if } m = 3 \pmod{6}, \\ +\frac{10}{21} & \text{if } m = 4 \pmod{6}, \\ -\frac{1}{21} & \text{if } m = 5 \pmod{6}. \end{cases}$$

For example, starting from  $m = 1$ , the values of  $\#(P'_m(1))$  are 3, 5, 8, 18, 36, 69 ... while the values of  $\#(P'_m(0))$  are 2, 5, 7, 18, 35, 69 ...

So, adding the values of  $\#(P'_m(1))$  and  $\#(P'_m(0))$ , the number of type III hyperbolic components of preperiod  $m$  is  $2^{m+1}(1 + \frac{2}{21}) + O(1)$ . We note in passing that centres of type IV components in  $V_3$  of periods dividing  $m$  are zeros of  $p_m$ . So the number of type IV hyperbolic components of period dividing  $m$ , and even of period exactly  $m$ , is  $2^m(1 + \frac{2}{21})(1 + o(1))$ .

We now consider the number of type III capture hyperbolic components. In fact we shall not do exactly this, because as already stated in 3.2, we do not have an asymptotic formula for the number of distinct Thurston equivalence classes of preperiod  $m$  among captures of the form  $\sigma_p \circ s_{3/7}$  for  $p \in (\frac{2}{7}, \frac{1}{3}) \cup (\frac{2}{3}, \frac{5}{7})$ . We shall actually give a recursive formula for the number of points in  $Z_m(s) \setminus Z_{m-1}(s)$  in specified subsets of the unit disc, and also give asymptotes of the number as  $m \rightarrow \infty$ . This will at least give a bound on the number of capture components, by Theorem 3.2. We only have three lamination maps to consider:  $s_{1/7}$ ,  $s_{3/7}$  and  $s_{6/7}$ . The descriptions of captures up to equivalence in sections 3.1 to 3.3 suggest that we should compute the numbers

$$a_{m,x,q} = \#(\{z \in D(q) : s_q^m(z) = x, s_q^{m-1}(z) \neq s_q^2(x)\}),$$

where  $x = c_1$  or  $s_q(v_1)$ , and  $D(q)$  is the following subset of the unit disc, for each of  $q = 1/7, 3/7, 6/7$ . If  $q = 1/7$  or  $q = 6/7$ , we take

$$D(q) = D(L_2) \cup D(C) \cup \Delta \cup D(R_1) \cup D(R_2),$$

for  $C, \Delta, R_1, R_2$  as in 2.9 for  $s_{1/7}$  (or  $s_{6/7}$ ). For  $q = \frac{3}{7}$ , we take  $D(3/7) = D(3/7, 1) \cup D(3/7, -1)$  where  $D(3/7, -1) = D(R_1) \cup D(R_2)$ , using the Markov partition of 2.9 for  $s_{3/7}$ , and  $D(3/7, 1) \subset D(L_3)$  is the region bounded by the leaves of  $L_{3/7}$  with endpoints at  $e^{\pm 2\pi i(1/3)}$  and  $e^{\pm 2\pi i(2/7)}$ . In terms of the symbolic dynamics,

$$D(3/7, 1) = \cup_{k=0}^{\infty} D(L_3^{2k+1}L_2).$$

We then define, for  $j = \pm 1$ ,  $x = s_{3/7}(v_1)$  or  $c_1$ ,

$$a_{m,x,3/7,j} = \#(\{z \in D(q, j) : s_q^m(z) = x, s_q^{m-1}(z) \neq s_q^2(x)\}).$$

First we consider the calculation of  $a_{m,x,q}$  for  $q = \frac{1}{7}, \frac{6}{7}$ , and  $x = c_1$  or  $s_q(v_1)$ . It turns out that the number  $a_{m,x,q}$  is the same for all four of these choices. We consider the Markov partition into the sets

$$L_1, L_2, C \cup \Delta \cup R_1 \cup R_2 = X.$$

The map  $s_q$ , for  $q = \frac{1}{7}$  or  $\frac{6}{7}$ , maps these partition elements as follows:

$$L_1 \rightarrow L_2, L_2 \rightarrow X, X \rightarrow X \cup L_2 \cup 2L_1,$$

where  $X \rightarrow 2L_1$  means that each point in  $L_1$  has two preimages under  $s$  in  $X$ , while  $X \rightarrow X$  (for example) means that each point in  $X$  has just one preimage in  $X$ . The corresponding matrix is

$$A_q = \begin{pmatrix} 0 & 1 & 0 \\ 0 & 0 & 1 \\ 2 & 1 & 1 \end{pmatrix} \text{ for which } A_q^2 = \begin{pmatrix} 0 & 0 & 1 \\ 2 & 1 & 1 \\ 2 & 3 & 2 \end{pmatrix},$$

where the first row of  $A_q$  indicates the degree of the map of  $L_1$  to each of  $L_1, L_2$  and  $X$ , and so on. The only nonzero entry of  $A_q$  in the first row, for example, is the second one, because  $L_1$  maps onto  $L_2$ , and the 1 indicates that the map onto  $L_2$  is degree 1. Note that all columns sum to 2, because  $s_q$  is degree two overall. Therefore, 2 is an eigenvalue, with eigenvector

$$v_q = \begin{pmatrix} 1 \\ 2 \\ 4 \end{pmatrix},$$

where this is easily deduced from either straight computation or from the relative lengths of  $L_1 \cap S^1, L_2 \cap S^1$  and  $X \cap S^1$ . The characteristic polynomial of  $A_q$  is

$$(\lambda - 2)(\lambda^2 + \lambda + 1).$$

The nullspace of  $A_q^2 + A_q + I$ , which, of course, is also the nullspace of  $A_q^3 - I$ , is

$$\left\{ \underline{x} = \begin{pmatrix} x_1 \\ x_2 \\ x_3 \end{pmatrix} : x_1 + x_2 + x_3 = 0. \right\}.$$

Now  $a_{m,x,q}$  is the sum of the second and third entries of

$$A_q^{m-1} \begin{pmatrix} 0 \\ 0 \\ 1 \end{pmatrix} = 2^{m-1} \begin{pmatrix} \frac{1}{7} \\ \frac{2}{7} \\ \frac{4}{7} \end{pmatrix} + A_q^{m-1} \begin{pmatrix} -\frac{1}{7} \\ -\frac{2}{7} \\ \frac{3}{7} \end{pmatrix}.$$

Now

$$A_q \begin{pmatrix} -\frac{1}{7} \\ -\frac{2}{7} \\ \frac{3}{7} \end{pmatrix} = \begin{pmatrix} -\frac{2}{7} \\ \frac{3}{7} \\ -\frac{1}{7} \end{pmatrix}, \quad A_q^2 \begin{pmatrix} -\frac{1}{7} \\ -\frac{2}{7} \\ \frac{3}{7} \end{pmatrix} = \begin{pmatrix} \frac{3}{7} \\ -\frac{1}{7} \\ -\frac{2}{7} \end{pmatrix}.$$

So

$$a_{m,x,q} = 2^m \cdot \frac{3}{7} \begin{cases} -\frac{3}{7} & \text{if } m = 0 \pmod{3}, \\ +\frac{1}{7} & \text{if } m = 1 \pmod{3}, \\ +\frac{2}{7} & \text{if } m = 2 \pmod{3}, \end{cases}$$

Now we consider the calculation of  $a_{m,x,3/7,1}$  and  $a_{m,x,3/7,-1}$  for  $x = c_1$  or  $s_{3/7}(v_1)$ . We use the partition of  $D(3/7)$  as the union of the sets  $D(3/7, 1)$  and  $D(3/7, -1)$ , and, correspondingly  $a_{m,x,3/7} = a_{m,x,3/7,1} + a_{m,x,3/7,-1}$ . It would be possible to do the computation using a different Markov partition from the one in 2.9, and, given the nature of the set  $D(3/7, 1)$ , it might seem more natural to do so, But in fact, because of a calculation we shall do later, in 3.5, it makes sense to use the partition we already have. In fact, we shall use the coarser partition into the four sets

$$L_1, L_2 \cup L_3 = X_1, C \cup R_3 = X_2, R_1 \cup R_2 = X_3.$$

This time,  $s_{3/7}$  maps these partition elements as follows:

$$L_1 \rightarrow X_3, X_1 \rightarrow X_1 \cup X_2, X_2 \rightarrow 2L_1 \cup X_1, X_3 \rightarrow X_3 \cup X_2.$$

The corresponding matrix is

$$A_{3/7} = \begin{pmatrix} 0 & 0 & 0 & 1 \\ 0 & 1 & 1 & 0 \\ 2 & 1 & 0 & 0 \\ 0 & 0 & 1 & 1 \end{pmatrix}, \quad \text{with } A_{3/7}^2 = \begin{pmatrix} 0 & 0 & 1 & 1 \\ 2 & 2 & 1 & 0 \\ 0 & 1 & 1 & 2 \\ 2 & 1 & 1 & 1 \end{pmatrix}.$$

Once again, 2 is an eigenvalue, this time with eigenvector

$$v_{3/7} = \begin{pmatrix} 1 \\ 2 \\ 2 \\ 2 \end{pmatrix}.$$

The characteristic polynomial is

$$(A_{3/7} - 2)(A_{3/7}^3 - 1).$$

Once again, the nullspace of  $A_{3/7}^3 - I$  is the set of vectors with coefficients summing to 0. Now  $a_{m,3/7,s(v_1),-1}$  and  $a_{m,c_1,3/7,-1}$  are the fourth entries of, respectively,

$$A_{3/7}^{m-1} \begin{pmatrix} 0 \\ 0 \\ 0 \\ 1 \end{pmatrix}, \quad A_{3/7}^{m-1} \begin{pmatrix} 0 \\ 1 \\ 0 \\ 0 \end{pmatrix}.$$

These column vectors are chosen because the nonperiodic preimages of  $s(v_1)$  and  $c_1$  are in  $X_3$  and  $X_1$  respectively, that is, the fourth and second elements of the Markov partition currently being used. Now

$$A_{3/7}^{m-1} \begin{pmatrix} 0 \\ 0 \\ 0 \\ 1 \end{pmatrix} = 2^{m-1} \begin{pmatrix} \frac{1}{7} \\ \frac{2}{7} \\ \frac{2}{7} \\ \frac{2}{7} \end{pmatrix} + A_{3/7}^{m-1} \begin{pmatrix} -\frac{1}{7} \\ -\frac{2}{7} \\ -\frac{2}{7} \\ \frac{5}{7} \end{pmatrix},$$

$$A_{3/7}^{m-1} \begin{pmatrix} 0 \\ 1 \\ 0 \\ 0 \end{pmatrix} = 2^{m-1} \begin{pmatrix} \frac{1}{7} \\ \frac{2}{7} \\ \frac{2}{7} \\ \frac{2}{7} \end{pmatrix} + A_{3/7}^{m-1} \begin{pmatrix} -\frac{1}{7} \\ \frac{5}{7} \\ -\frac{2}{7} \\ -\frac{2}{7} \end{pmatrix}.$$

Now

$$A_{3/7} \begin{pmatrix} -\frac{1}{7} \\ -\frac{2}{7} \\ -\frac{2}{7} \\ \frac{5}{7} \end{pmatrix} = \begin{pmatrix} \frac{5}{7} \\ -\frac{4}{7} \\ -\frac{4}{7} \\ \frac{3}{7} \end{pmatrix}, \quad A_{3/7}^2 \begin{pmatrix} -\frac{1}{7} \\ -\frac{2}{7} \\ -\frac{2}{7} \\ \frac{5}{7} \end{pmatrix} = \begin{pmatrix} \frac{3}{7} \\ -\frac{8}{7} \\ \frac{6}{7} \\ -\frac{1}{7} \end{pmatrix},$$

$$A_{3/7} \begin{pmatrix} -\frac{1}{7} \\ \frac{5}{7} \\ -\frac{2}{7} \\ -\frac{2}{7} \end{pmatrix} = \begin{pmatrix} -\frac{2}{7} \\ \frac{3}{7} \\ \frac{3}{7} \\ -\frac{4}{7} \end{pmatrix}, \quad A_{3/7}^2 \begin{pmatrix} -\frac{1}{7} \\ \frac{5}{7} \\ -\frac{2}{7} \\ -\frac{2}{7} \end{pmatrix} = \begin{pmatrix} -\frac{4}{7} \\ \frac{6}{7} \\ -\frac{1}{7} \\ -\frac{1}{7} \end{pmatrix}.$$

So

$$a_{m,s(v_1),3/7,-1} = \frac{1}{7} \cdot 2^m \begin{cases} -\frac{1}{7} & \text{if } m \equiv 0 \pmod{3}, \\ +\frac{5}{7} & \text{if } m \equiv 1 \pmod{3}, \\ +\frac{3}{7} & \text{if } m \equiv 2 \pmod{3}, \end{cases}$$

$$a_{m,c_1,3/7,-1} = \frac{1}{7} \cdot 2^m \begin{cases} -\frac{1}{7} & \text{if } m \equiv 0 \pmod{3}, \\ -\frac{2}{7} & \text{if } m \equiv 1 \pmod{3}, \\ -\frac{4}{7} & \text{if } m \equiv 2 \pmod{3}. \end{cases}$$

For future reference, we record

$$(3.4.3) \quad a_{m,1/7,s(v_1)} + a_{m,6/7,s(v_1)} + a_{m,3/7,s(v_1),-1} = 2^m \begin{cases} -1 & \text{if } m \equiv 0 \pmod{3}, \\ +1 & \text{if } m \equiv 1 \pmod{3}, \\ +1 & \text{if } m \equiv 2 \pmod{3}, \end{cases}$$

$$(3.4.4) \quad a_{m,1/7,c_1} + a_{m,6/7,c_1} + a_{m,3/7,c_1,-1} = 2^m \begin{cases} -1 & \text{if } m \equiv 0 \pmod{3}, \\ +0 & \text{if } m \equiv 1 \pmod{3}, \\ +0 & \text{if } m \equiv 2 \pmod{3}. \end{cases}$$

The calculation of  $a_{m,x,3/7,1}$  is a little less direct. First we note that, for  $m \geq 2$ ,

$$b_{m,s(v_1)} = \#\{z \in D(L_3L_2) : s_{3/7}^m(z) = s_{3/7}(v_1), s_{3/7}^{m-1}(z) \neq v_1\}$$

$$= \#\{z \in X_2 : s_{3/7}^{m-2}(z) = s_{3/7}(v_1), s_{3/7}^{m-3}(z) \neq v_1\},$$

where the last condition  $s_{3/7}^{m-3}(z) \neq v_1$  is dropped if  $m = 2$ . Then  $b_{1,s(v_1)} = 0 = b_{2,s(v_1)}$  and, for  $m \geq 3$ ,  $b_{m,s(v_1)}$  is the third entry of

$$A_{3/7}^{m-3} \begin{pmatrix} 0 \\ 0 \\ 0 \\ 1 \end{pmatrix}.$$

So if  $m \geq 3$ ,

$$b_{m,s(v_1)} = \frac{1}{28} \cdot 2^m \begin{cases} -\frac{2}{7} & \text{if } m \equiv 0 \pmod{3}, \\ -\frac{4}{7} & \text{if } m \equiv 1 \pmod{3}, \\ +\frac{6}{7} & \text{if } m \equiv 2 \pmod{3}. \end{cases}$$



If we define  $b_{m,c_1}$  similarly then  $b_{1,c_1} = 0$ ,  $b_{2,c_1} = 1$ , and for  $m \geq 3$  we have

$$b_{m,c_1} = \frac{1}{28} \cdot 2^m + \begin{cases} -\frac{2}{7} & \text{if } m = 0 \pmod{3}, \\ +\frac{3}{7} & \text{if } m = 1 \pmod{3}, \\ -\frac{1}{7} & \text{if } m = 2 \pmod{3}. \end{cases}$$

Then we can obtain  $a_{m,3/7,x,1}$  from

$$a_{m,x,3/7,1} = \sum_{m-2-2k \geq 0} b_{m-2k,x}.$$

So we obtain

$$a_{m,s(v_1),3/7,1} = \frac{1}{21} \cdot 2^m \begin{cases} -\frac{22}{21} & \text{if } m = 0 \pmod{6}, \\ -\frac{2}{21} & \text{if } m = 1 \pmod{6}, \\ -\frac{4}{21} & \text{if } m = 2 \pmod{6}, \\ -\frac{8}{21} & \text{if } m = 3 \pmod{6}, \\ -\frac{16}{21} & \text{if } m = 4 \pmod{6}, \\ +\frac{10}{21} & \text{if } m = 5 \pmod{6}, \end{cases}$$

$$a_{m,c_1,3/7,1} = \frac{1}{21} \cdot 2^m \begin{cases} +\frac{22}{21} & \text{if } m = 0 \pmod{6}, \\ -\frac{2}{21} & \text{if } m = 1 \pmod{6}, \\ +\frac{17}{21} & \text{if } m = 2 \pmod{6}, \\ -\frac{8}{21} & \text{if } m = 3 \pmod{6}, \\ +\frac{26}{21} & \text{if } m = 4 \pmod{6}, \\ -\frac{11}{21} & \text{if } m = 5 \pmod{6}. \end{cases}$$

So we obtain, if  $m \geq 2$ , if

$$t(s(v_1)) = a_{m,1/7,s(v_1)} + a_{m,6/7,s(v_1)} + a_{m,s(v_1),3/7,-1} + a_{m,s(v_1),3/7,1},$$

then:

$$(3.4.5) \quad t(s(v_1)) = \left(1 + \frac{1}{21}\right) \cdot 2^m \begin{cases} -\frac{43}{21} & \text{if } m = 0 \pmod{6}, \\ +\frac{19}{21} & \text{if } m = 1 \pmod{6}, \\ +\frac{17}{21} & \text{if } m = 2 \pmod{6}, \\ -\frac{29}{21} & \text{if } m = 3 \pmod{6}, \\ +\frac{5}{21} & \text{if } m = 4 \pmod{6}, \\ +\frac{31}{21} & \text{if } m = 5 \pmod{6}. \end{cases}$$

The first 6 numbers are

$$3, 5, 7, 17, 35, 65,$$

compared with the values 3, 5, 8, 18, 36, 69 of  $\#(P'_m(1))$

Similarly, if

$$t(c_1) = a_{m,1/7,c_1} + a_{m,6/7,c_1} + a_{m,c_1,3/7,-1} + a_{m,c_1,3/7,1},$$

then:

$$(3.4.6) \quad t(c_1) = \left(1 + \frac{1}{21}\right) \cdot 2^m \begin{cases} -\frac{1}{21} & \text{if } m = 0 \pmod 6, \\ -\frac{2}{21} & \text{if } m = 1 \pmod 6, \\ +\frac{17}{21} & \text{if } m = 2 \pmod 6, \\ -\frac{29}{21} & \text{if } m = 3 \pmod 6, \\ +\frac{26}{21} & \text{if } m = 4 \pmod 6, \\ -\frac{11}{21} & \text{if } m = 5 \pmod 6 \end{cases}$$

The first 6 numbers are

$$2, 5, 7, 18, 33, 67,$$

compared with the values 2, 5, 7, 18, 35, 69 of  $\#(P'_m(0))$ . The deficit of the captures from the total in this case is slightly less than it appears to be, because in the cases of preperiods 5, the two captures  $\sigma_r \circ s_{3/7}$  with  $e^{2\pi i r}$  in the boundary of the gap coded by  $L_3L_2R_3L_3L_2C$  are not Thurston equivalent, and are not Thurston equivalent to any other captures. Similar properties hold for the two preperiod 6 captures corresponding to the gap coded by  $L_3L_2R_3L_3^2L_2C$ .

Overall, the deficit of  $t(c_1)$  and  $t(s(v_1))$  compared to the values of  $\#(P'_m(0))$  and  $\#(P'_m(1))$  is equal to

$$\frac{1}{21} \cdot 2^m + O(1).$$

This calculation shows that, asymptotically, at most half of the points of  $P_{3,m}(a_1, +)$  are Thurston equivalent to captures, that is, at most  $\frac{1}{21}2^m(1 + o(1))$  out of  $\frac{2}{21}2^m(1 + o(1))$ . In fact, it is probably considerably less. I would guess that the number is  $c2^m(1 + o(1))$  for some  $c > 0$  which can be determined. It is interesting to note that the average image size of a map from a set of  $n_1$  elements to a set of  $n_2$  elements is

$$n_2 \left(1 - \left(1 - \frac{1}{n_2}\right)\right)^{n_1}.$$

I thank my colleague Jonathan Woolf for producing and deriving this formula. If  $n_2 = 2n_1(1 + o(1))$  then this gives

$$n_2(1 - e^{-1/2})(1 + o(1)).$$

### 3.5. Check on the numbers in Theorem 2.10

Theorem 2.10 includes a precise formula for the number of type III hyperbolic components of preperiod  $m$  of each of the two possible types, that is, with  $\frac{2a}{a+1}$  in the backward orbit of  $\frac{a}{a+1}$  or  $a$ . Let  $U^p$  be as in 2.10. Throughout this section, let  $s = s_{3/7}$ . Similarly to the numbers  $a_{m,x,q}$  as in 3.4, we define

$$d_{m,x} = \#\left(\{z \in D(L_2) : s_{3/7}^m(z) = x, s_{3/7}^{m-1}(z) \neq s_{3/7}^2(x)\}\right),$$

$$e_{m,x} = \#\left(\{z \in D(BC) : s_{3/7}^m(z) = x, s_{3/7}^{m-1}(z) \neq s_{3/7}^2(x)\}\right),$$

for each of  $x = s_{3/7}(v_1)$  and  $x = c_1$ , and let

$$f_{m,p,x} = \#\left(\{z \in U^p : s_{3/7}^m(z) = x, s_{3/7}^{m-1}(z) \neq s_{3/7}^2(x)\}\right)$$

and

$$c_{m,x} = \sum_{p \geq 0} f_{m,p,x}.$$

In the terminology of 3.5, Theorem 2.10 implies that the number of type III hyperbolic components with  $\frac{2a}{a+1}$  in the backward orbit of  $\frac{a}{a+1}$  or  $a$  is

$$(3.5.1) \quad a_{m,x,1/7} + a_{m,x,6/7} + a_{m,x,3/7,-1} + c_{m,x}$$

where  $x$  is, respectively,  $s(v_1)$  or  $c_1$ . The numbers of hyperbolic components are bounded by, respectively,  $\#(P'_m(1))$  and  $\#(P'_m(0))$ . So a useful check on the validity of the theorem is to show that the numbers in (3.5.1) are, for  $x = s_{3/7}(v_1)$  and  $x = c_1$  respectively,  $\#(P'_m(1))$  and  $\#(P'_m(0))$ . The numbers  $a_{m,x,1/7} + a_{m,x,6/7} + a_{m,x,3/7,-1}$  are given in (3.4.3) and (3.4.4). So we only need to compute the numbers  $c_{m,x}$ , which are computed in terms of the numbers  $f_{m,p,x}$ . Now we claim that, if  $p \geq 0$ ,

$$f_{m,p+1,x} = f_{m-2,p,x} = f_{m-2p-2,0,x}.$$

There is a lot of cancellation in  $U^p$  for  $p \geq 1$ :

- . Points in  $S_{1,p,k+1}D(L_2)$  cancel with points in  $S_{1,p,k}D(v_{p,0})$  for  $k \geq 0$ . The length of the word ending in  $L_2$  in both cases is  $4p + 4 + k(2p + 3)$ ;
- . Points in  $S_{2,p,k}D(v_{t,n})$  cancel with points in  $S_{1,p,k}D(v_{t-1,n})$  for all  $n \geq 0$  and  $k \geq 0$  and  $2 \leq t \leq p$ ;
- . Points in  $S_{2,p,k+1}D(v_{1,0})$  cancel with points in  $S_{1,p,k}D(v_{p,1})$ . In both cases the lengths of words are  $4p + 8 + k(2p + 3)$ ;
- . Points in  $S_{2,p,k+1}D(v_{1,n-1})$  cancel with points in  $S_{1,p,k}D(v_{p,n})$  for  $n \geq 2$  and  $k \geq 0$ . Both have length  $4p + 5 + 3n + k(2p + 3)$ ;
- . Points in  $S_{2,p,k+1}D(u_n)$  cancel with points in  $S_{2,p,k}D((L_2R_3)^2L_3^{2p-1}u_n)$  for  $k \geq 0$ ;
- . Points in  $S_{1,p,k}D((L_2R_3)^2L_3^{2p-1}u_n)$  cancel with points in  $S_{2,p,k+1}D(u_n)$  for  $k \geq 0$ .

So we are left with points in  $S_{2,p,0}D(v_{1,0})$  and points in  $S_{2,p,0}D(u_n)$  minus points in  $S_{1,p,0}D(u_n)$  for  $n \geq 0$  and points in  $S_{2,p,0}D(v_{1,k})$  for  $k \geq 0$ . Note that  $S_{2,p,0}D(u_k)$  and  $S_{1,p,0}D(u_k)$  map under  $s^{2p+3k}$  and  $s^{2p+2+3k}$  to  $D(BC)$  and  $S_{2,0}D(v_{1,k})$  maps under  $s^{2p+3k}$  to  $D(L_3L_2)$ , while  $D(L_3^{3k-1}L_2BC)$  and  $D(L_3^{3k+1}L_2)$  map under  $s^{3k}$  to  $D(BC)$  and  $D(L_3L_2)$  respectively.

So we deduce that, for  $p \geq 0$ ,

$$f_{m,p,x} = f_{m-2,p-1,x} = f_{m-2p,0,x}.$$

So

$$c_{m,x} = \sum_{2p \leq m} f_{m-2p,0,x}.$$

Note that

$$f_{m,0,x} = \sum_{k \geq 0, 3k \leq m} (e_{m-3k,x} + d_{m-3k-1,x} - e_{m-3k-2,x}).$$

Here we define  $e_{r,x} = 0$  if  $r \leq 0$ .

Then in the terminology we have previously used, in particular in 3.4,  $D(L_2)$  maps homeomorphically under  $s$  to  $D(C) \cup D(R_3)$ , and  $D(BC)$  maps homeomorphically under  $s^2$  to  $D(R_1) \cup D(R_2)$ , and  $D(L_3L_2BC) = S_{1,0,0}D(u_0)$  maps homeomorphically under  $s^4$  to  $D(R_1) \cup D(R_2)$ . Let

$$\underline{v} = \begin{pmatrix} 0 \\ 0 \\ 0 \\ 1 \end{pmatrix} \text{ or } \begin{pmatrix} 0 \\ 1 \\ 0 \\ 0 \end{pmatrix},$$

depending on whether  $x = s(v_1)$  or  $c_1$ . Then similarly to the calculation of  $b_{m,x}$  in 3.4, with matrix  $A = A_{3/7}$  as in 3.4,  $d_{m-1,x}$  and  $e_{m,x}$  are the third and fourth entries respectively of  $A^{m-3}(\underline{v})$  for  $m \geq 3$ . Using the decomposition of  $\underline{v}$  as a sum of an eigenvector of  $A$  with eigenvalue 2 and a vector in the sum of the other eigenspaces of  $A$ , we obtain, for  $m \geq 4$ ,

$$e_{m,s(v_1)} + d_{m-1,s(v_1)} - e_{m-2,s(v_1)} = \frac{4}{7} \cdot 2^{m-3} - \frac{2}{7} \cdot 2^{m-5} + \begin{cases} -\frac{2}{7} + \frac{5}{7} - (\frac{3}{7}) & (\text{if } m = 0 \text{ mod } 3) \\ -\frac{4}{7} + \frac{3}{7} - (-\frac{1}{7}) & (\text{if } m = 1 \text{ mod } 3) \\ \frac{6}{7} - \frac{1}{7} - (\frac{5}{7}) & (\text{if } m = 2 \text{ mod } 3) \end{cases} = 2^{m-4} + 0,$$

and

$$e_{m,c_1} + d_{m-1,c_1} - e_{m-2,c_1} =$$

$$\frac{4}{7} \cdot 2^{m-3} - \frac{2}{7} \cdot 2^{m-5} + \begin{cases} -\frac{2}{7} - \frac{2}{7} - (-\frac{4}{7}) & (\text{if } m = 0 \pmod{3}) \\ \frac{3}{7} - \frac{4}{7} - (-\frac{1}{7}) & (\text{if } m = 1 \pmod{3}) \\ -\frac{1}{7} - \frac{1}{7} - (-\frac{2}{7}) & (\text{if } m = 2 \pmod{3}) \end{cases} = 2^{m-4} + 0.$$

We can also check that

$$\begin{aligned} d_{1,s(v_1)} &= d_{2,s(v_1)} = 0, \\ d_{1,c_1} &= 0, \quad d_{2,c_1} = 1, \\ e_{r,x} &= 0 \text{ for } r < 3 \text{ and } x = s(v_1) \text{ or } c_1, \\ e_{3,s(v_1)} &= 1, \quad e_{3,c_1} = 0. \end{aligned}$$

So

$$\begin{aligned} e_{3,s(v_1)} + d_{2,s(v_1)} - e_{1,s(v_1)} &= 1, \\ e_{3,c_1} + d_{2,c_1} - e_{1,c_1} &= 0. \end{aligned}$$

We can then check that

$$(3.5.2) \quad f_{m,0,s(v_1)} = \frac{1}{14} 2^m \begin{cases} +\frac{3}{7} & \text{if } m = 0 \pmod{3}, \\ -\frac{1}{7} & \text{if } m = 1 \pmod{3}, \\ -\frac{2}{7} & \text{if } m = 2 \pmod{3}. \end{cases}$$

So then we obtain

$$(3.5.3) \quad c_{m,s(v_1)} = \frac{2}{21} 2^m \begin{cases} -\frac{2}{21} & \text{if } m = 0 \pmod{6}, \\ -\frac{4}{21} & \text{if } m = 1 \pmod{6}, \\ -\frac{8}{21} & \text{if } m = 2 \pmod{6}, \\ +\frac{5}{21} & \text{if } m = 3 \pmod{6}, \\ -\frac{11}{21} & \text{if } m = 4 \pmod{6}, \\ -\frac{1}{21} & \text{if } m = 5 \pmod{6}. \end{cases}$$

From this we obtain that

$$a_{m,s(v_1),1/7} + a_{m,s(v_1),6/7} + a_{m,s(v_1),3/7,-1} + c_{m,s(v_1)} = \#(P'_m(1)),$$

as we wanted to check. The calculations for  $f_{m,0,c_1}$  and  $c_{m,c_1}$  are similar, taking onto account the different values of  $d_{m,c_1}$ . We have

$$(3.5.4) \quad f_{m,0,c_1} = \frac{1}{14} 2^m \begin{cases} -\frac{4}{7} & \text{if } m = 0 \pmod{3}, \\ -\frac{1}{7} & \text{if } m = 1 \pmod{3}, \\ +\frac{5}{7} & \text{if } m = 2 \pmod{3}. \end{cases}$$

So

$$(3.5.5) \quad c_{m,c_1} = \frac{2}{21} 2^m \begin{cases} -\frac{2}{21} & \text{if } m = 0 \pmod{6}, \\ -\frac{4}{21} & \text{if } m = 1 \pmod{6}, \\ +\frac{13}{21} & \text{if } m = 2 \pmod{6}, \\ -\frac{16}{21} & \text{if } m = 3 \pmod{6}, \\ +\frac{10}{21} & \text{if } m = 4 \pmod{6}, \\ -\frac{1}{21} & \text{if } m = 5 \pmod{6}. \end{cases}$$

From this we obtain that

$$a_{m,c_1,1/7} + a_{m,c_1,6/7} + a_{m,c_1,3/7,-1} + c_{m,c_1} = \#(P'_m(0)),$$

as we wanted to check.

## CHAPTER 4

### THE RESIDENT'S VIEW

#### 4.1.

In this section we recall the theory of the Resident's View from [31] as we need it. The basic idea is that we shall describe  $V_3$  in terms of the dynamical planes of the three maps  $h_{a_0}$ ,  $h_{\bar{a}_0}$  and  $h_{a_1}$  of  $V_3$  which are Möbius conjugate to polynomials, and which are Thurston equivalent to the maps  $s_{1/7}$ ,  $s_{6/7}$  and  $s_{3/7}$ . Recall from the diagram of 2.2 that  $V_3(a_0)$  and  $V_3(\bar{a}_0)$  are the regions in the upper and lower half-planes respectively bounded by the hyperbolic components  $H_{\pm 1}$ , that  $V_3(a_1, -)$  is bounded by  $H_{a_1}$  and  $H_{-1}$ , and  $V_3(a_1, +)$  by  $H_{a_1}$  and  $H_1$ . We shall use the dynamical planes of

$$s_{1/7}, \quad s_{6/7}, \quad s_{3/7},$$

to describe the regions

$$V_3(a_0), \quad V_3(\bar{a}_0), \quad V_3(a_1, \pm).$$

This means that we identify type III hyperbolic components of preperiod  $\leq m$  in  $V_3$  with points in the set  $Z_m(s)$ , where  $s = s_{1/7}$  or  $s_{6/7}$ , or  $s_{3/7}$ . Since the Resident's View is actually an identification between universal covers, that is, by paths to points rather than simply the endpoints of the paths, there is no general reason why we should have a one-to-one correspondence between the set of type III hyperbolic components of preperiod  $\leq m$  in  $V_3$  with points in the set and subsets of the sets  $Z_m(s_q)$ , for  $q = \frac{1}{7}$  or  $\frac{6}{7}$  or  $\frac{3}{7}$ . But in fact we do find such a correspondence in  $V_3(a_0)$  and  $V_3(\bar{a}_0)$  and  $V_3(a_1, -)$ . The correspondence is many-to-one for  $V_3(a_1, +)$ . The precise statement will have to wait until the main theorem in 7.11. All the theory described in this section works for any  $V_{n,m}$  or  $B_{n,m}$ , but we shall be applying it only in the case  $n = 3$  in the present paper. So, to simplify notation a bit, we restrict to the case  $n = 3$ .

## 4.2. The maps $\Phi_1, \Phi_2, \rho$

We fix  $m$  and  $g_0 \in B_{3,m}$  for which  $g_0(v_2) = v_2$ . If  $g_0 \in V_{3,m}$  then  $g_0 = h_a$  for  $a = a_0$  or  $\overline{a_0}$  or  $a_1$ . We shall always take  $g_0$  to be one of these, or  $g_0 = s_q$  for  $q = \frac{1}{7}$  or  $\frac{6}{7}$  or  $\frac{3}{7}$ , where these are as in 2.3. Although these maps are not in  $V_{3,m}$ , the map  $s_{1/7}$  is Thurston equivalent to  $h_{a_0}$ , and  $s_{6/7}$  to  $h_{\overline{a_0}}$  and  $s_{3/7}$  to  $h_{a_1}$ . We write  $v_1$  and  $v_2$  for the critical values of  $g_0$ , with  $v_1$  of period 3. Because Thurston equivalence classes of these maps are simply connected (using our conventions, as noted in 2.4) there is a unique path, up to homotopy in  $B_{3,m}$ , joining  $s_{1/7}$  and  $h_{a_0}$  in their common Thurston equivalence class, and similarly for the other pairs. Inclusion of  $V_{3,m}$  in  $B_{3,m}$  therefore gives rise to a natural homomorphism from  $\pi_1(V_{3,m}, h_a)$  to  $\pi_1(B_{3,m}, s_q)$ , for each of  $(a, q) = (a_0, \frac{1}{7})$  or  $(\overline{a_0}, \frac{6}{7})$  or  $(a_1, \frac{3}{7})$ . One of the main results of [31] is that this homomorphism is injective. By abuse of notation we therefore write  $\pi_1(V_{3,m}, s_q)$  for the resulting subgroup of  $\pi_1(B_{3,m}, s_q)$ . For any pair of spaces  $(X, A)$  with  $A \subset X$ , and  $x \in X$  we write  $\pi_1(X \setminus A, A, x)$  for the set of homotopy classes of paths from  $x$  to  $A$ , intersecting  $A$  only in the second endpoint, using homotopies preserving  $A$  and  $x$ . Then, similarly to the above, we write  $\pi_1(V_{3,m}, P_{3,m}, s_q)$  for the subset of  $\pi_1(B_{3,m}, P_{3,m}, s_q)$  of homotopy classes which can be represented as a path in the Thurston equivalence class of  $s_q$  and  $h_{a_0}$  from  $s_q$  to  $h_{a_0}$ , followed by an element of  $\pi_1(V_{3,m}, P_{3,m}, h_{a_0})$ .

So now we let  $g_0$  be any of these six maps  $h_a$  or  $s_q$ . We also write  $Z_m = Z_m(g_0)$  and  $Y_m = Z_m \cup \{v_2\}$ . The universal cover of  $\overline{\mathbb{C}} \setminus Z_m$  is conformally the unit disc  $D$ , for all  $m \geq 0$ . The *Resident's View* of [31] identifies the universal cover of  $V_{3,m}$  with a subset of the universal cover of  $\overline{\mathbb{C}} \setminus Z_m$  which is the disc. This is done using set-theoretic injections

$$\rho = \rho(\cdot, g_0) : \pi_1(B_{3,m}, g_0) \rightarrow \pi_1(\overline{\mathbb{C}} \setminus Z_m, v_2),$$

$$\rho_2 = \rho_2(\cdot, g_0) : \pi_1(B_{3,m}, N_{3,m}, g_0) \rightarrow \pi_1(\overline{\mathbb{C}} \setminus Z_m, Z_m, v_2)$$

which are defined in 1.12 of [31]. These combine with the injective-on- $\pi_1$  inclusions of  $V_{3,m}$  in  $B_{3,m}$  and of  $(V_{3,m}, P_{3,m})$  in  $(B_{3,m}, N_{3,m})$  (of which the proof takes up perhaps half of [31]) to give set-theoretic injections

$$\rho : \pi_1(V_{3,m}, g_0) \rightarrow \pi_1(\overline{\mathbb{C}} \setminus Z_m, v_2),$$

$$\rho_2 : \pi_1(V_{3,m}, P_{3,m}, g_0) \rightarrow \pi_1(\overline{\mathbb{C}} \setminus Z_m, Z_m, v_2).$$

From now on in this work, we shall simply write  $\rho$  for the maps which were called  $\rho$  and  $\rho_2$  in [31]. The definitions are very similar. Only the domains are different. We now recall the definitions in the present context, considering just the definitions on  $\pi_1(V_{3,m}, g_0)$  and  $\pi_1(V_{3,m}, P_{3,m}, g_0)$ . Let  $t \mapsto g_t : [0, 1] \rightarrow V_{3,m}$  be either a closed path starting and ending at  $g_0$  (for the definition of  $\rho$ ) or a path from  $g_0$  to a small neighborhood of a point of  $P_{3,m} \setminus P_{3,0}$  (for the definition of  $\rho_2$ ). Then the path  $g_t$  defines



a path  $\varphi_t$  of homeomorphisms of  $\overline{\mathbb{C}}$  where  $\varphi_0$  is the identity and  $\varphi_t$  maps  $Z_m = Z_m(g_0)$  to  $Z_m(g_t)$  and  $v_2(g_0)$  to  $v_2(g_t)$ . There is also a lifted path of homeomorphisms  $\psi_t$  defined by  $g_t \circ \psi_t = \varphi_t \circ g_0$ , such that  $\psi_0$  is the identity with  $\psi_t(c_j(g_0)) = c_j(g_t)$  for  $j = 1, 2$ . Standard covering space theory gives the lift of  $\varphi_t$  to a homeomorphism  $\psi_t$  of  $\overline{\mathbb{C}} \setminus \{c_1(g_0), c_2(g_0)\}$  to  $\overline{\mathbb{C}} \setminus \{c_1(g_t), c_2(g_t)\}$ , but this extends to a homeomorphism mapping  $c_j(g_0)$  to  $c_j(g_t)$  for  $j = 1, 2$ . By continuity in  $t$ , since  $\psi_t(Z_m) \subset g_t^{-1}(Z_m(g_t))$ , it follows that  $\psi_t = \varphi_t$  on  $Z_m$ , and  $\varphi_t$  and  $\psi_t$  are isotopic via an isotopy which is constant on  $Z_m$ . It follows that there is a path  $\alpha_t$  starting from  $v_2(g_0)$  in  $\overline{\mathbb{C}} \setminus Z_m$  such that  $\varphi_t$  and  $\psi_t \circ \sigma_{\alpha_t}$  are isotopic via an isotopy constant on  $Z_m \cup \{v_2(g_0)\}$ . Here, for any path  $\gamma$ , the homeomorphism  $\sigma_\gamma$  is as in 2.5. In the case when  $t \mapsto g_t$  is a closed path,  $\alpha = \alpha_1$  is also a closed path, whose homotopy class in  $\pi_1(\overline{\mathbb{C}} \setminus Z_m, v_2)$  depends only on the homotopy class of  $t \mapsto g_t$  in  $\pi_1(V_{3,m}, g_0)$ . So in this case we take

$$\rho([t \mapsto g_t]) = [\alpha].$$

We also define

$$\Phi_1([t \mapsto g_t]) = [\varphi_1]$$

and

$$\Phi_2([t \mapsto g_t]) = [\psi_1].$$

Then  $\Phi_1$  and  $\Phi_2$  are anti-homomorphisms into the modular groups  $\text{MG}(\overline{\mathbb{C}}, Y_m)$ ,  $\text{MG}(\overline{\mathbb{C}}, Y_{m+1})$  respectively. It is shown in 1.11 of [31] that they are injective on  $\pi_1(B_{3,m}, g_0)$ . It is pointed out in 1.13 of [31] that

$$(4.2.1) \quad \sigma_\alpha \circ g_0 \simeq_{\psi_1} g_0,$$

for  $\alpha = \rho([t \mapsto g_t])$  and  $\psi_1 = \Phi_2([t \mapsto g_t])$  as above, where, as earlier,  $\simeq$  denotes Thurston equivalence of critically finite branched coverings and  $\simeq_{\psi_1}$  is as in 2.4. In fact (4.2.1) is the defining equation of

$$G_2 = \Phi_2(\pi_1(B_{3,m}, g_0)),$$

or at least one form of the defining equation. The group

$$G_1 = \Phi_1(\pi_1(B_{3,m}, g_0))$$

is equivalently characterized by

$$(4.2.2) \quad G_1 = \left\{ \begin{array}{l} [\varphi] \in \text{MG}(\overline{\mathbb{C}}, Y_m) : [\varphi] = [\sigma_\alpha \circ \psi], \\ \text{for at least one } \psi \text{ with } \varphi \circ g_0 = g_0 \circ \psi, \\ \alpha \in \pi_1(\overline{\mathbb{C}} \setminus Z_m, v_2) \end{array} \right\}.$$

Here, part of the definition given by (4.2.2) is that at least one lift  $\psi$  of  $\varphi$  by the equation  $g_0 \circ \psi = \varphi \circ g_0$  satisfies  $\psi = \varphi$  on  $Z_m$ . For further details, see 1.11 to 1.13 of [31].

We now consider the definition on  $\pi_1(V_{3,m}, P_{3,m}, g_0)$ . We shall again want to obtain (4.2.1), with  $\alpha = \rho(g_t)$ . Recall that the Polynomial-and-Path Theorem of [29] says that every critically finite type III quadratic rational map is Thurston-equivalent to a map of the form  $\sigma_\alpha \circ g_0$  for some  $g_0$  which is Thurston equivalent to a polynomial, and for some path  $\alpha$  from  $v_2(g_0)$  to  $Z_m(g_0)$ . First, we consider a path  $g_t$  with  $g_0$  as before, and with  $g_1$  close to an element of  $P_{3,m} \setminus P_{3,0}$ , rather than equal to such an element. Then we can take  $\varphi_t^{-1}$  bounded except near  $v_2(g_t)$ , for  $t$  near 1. This means that  $\psi_t^{-1}$  is bounded near  $c_2(g_t)$ , and the second endpoint of  $\alpha_t$  is near the corresponding point of  $Z_m$  for  $t$  near 1. We then extend  $\alpha_1$  by a small arc to a path  $\alpha$  from  $v_2(g_0)$  to  $Z_m$ . Once again, the class of  $\alpha$  in  $\pi_1(\mathbb{C} \setminus Z_m, Z_m, v_2)$  depends only on the isotopy class of the path in  $\pi_1(V_{3,m}, P_{3,m}, g_0)$  which is a small extension of  $t \mapsto g_t$ . So this defines the map  $\rho$  on  $\pi_1(V_{3,m}, P_{3,m}, g_0)$ . We then have (4.2.1) as before.

If  $(a, q) = (a_0, \frac{1}{7})$  or  $(\overline{a_0}, \frac{6}{7})$  or  $(a_1, \frac{3}{7})$ , the images under  $\rho(\cdot, h_a)$  and  $\rho(\cdot, s_q)$  in homotopy classes in the dynamical planes of  $h_a$  or  $s_q$  correspond under any suitably close homeomorphism approximation to the semiconjugacy between  $s_q$  and  $h_a$ , since the quotient map of  $s_q$  on the quotient of the invariant lamination  $L_q$  is conjugate to  $h_a$  on the Julia set  $J(h_a)$ . If we define  $\beta = \rho(t \mapsto g_t, s_q)$ , then

$$\sigma_\beta \circ s \simeq g_1.$$

Moreover, we can recover  $g_1$  up to conjugacy from  $\beta$  and  $s_q$ . This is described in the Lamination Map Conjugacy and Lamination Map Equivalence Theorems of [29], and works as follows. Let  $L_\beta$  be the closure of the set of geodesics homotopic to the paths of

$$\bigcup_{n=0}^{\infty} (\sigma_\beta \circ s_q)^{-n}(L_q).$$

Then an easy homotopy gives a Thurston equivalence between  $\sigma_\beta \circ s_q$  and a map (unfortunately, in view of the use of  $\rho$  in [31] and in the current paper, called  $\rho_{L_\beta}$  in [29]) which preserves  $L_\beta$ , and is semiconjugate to  $g_1$ , under a semiconjugacy which collapses each leaf of  $L_\beta$  to a point, but a little more: the preimages of points are equivalence classes of the smallest closed equivalence relation generated by: each leaf of  $L_\beta$  is in a single equivalence class.

The point of the current work, and the way to prove Theorem 2.10, is to choose a fundamental domain for  $V_{3,m}$ . This means choosing an open topological disc  $U$  in  $V_{3,m}$ , containing  $g_0 \in V_{3,m}$ , whose complement is a union of edges joining up the points of  $P_{3,m}$  to form a tree. Up to homotopy preserving  $g_0$  and  $P_{3,m}$ , there is then a one-to-one correspondence between points in  $V_{3,m}$ , and the set of paths in  $U$  from  $g_0$  to  $P_{3,m}$ . Using  $\rho$ , this will then give a one-to-one correspondence between  $P_{3,m}$  and a certain set of paths in  $\pi_1(\mathbb{C} \setminus Z_m, Z_m, v_2)$ . Using (4.2.1), this will give a single chosen representation of the centre of each type III hyperbolic component of preperiod  $\leq m$  in the form  $\sigma_\beta \circ g_0$ .

### 4.3. The Resident's View of Rational Maps Space

Now  $\pi_1(V_{3,m}, g_0)$  and  $\pi_1(\overline{\mathbb{C}} \setminus Z_m, v_2)$  are naturally embedded in the universal covers of  $V_{3,m}$  and  $\overline{\mathbb{C}} \setminus Z_m$  respectively, both of which identify conformally with the unit disc  $D$ . To make the natural embeddings, of course we have to fix preimages  $\tilde{g}_0$  and  $\tilde{v}_2$  of  $g_0$  and  $v_2$  in the universal covers. In the same way,  $\pi_1(V_{3,m}, P_{3,m}, g_0)$  and  $\pi_1(\overline{\mathbb{C}} \setminus Z_m, Z_m, v_2)$  identify with subsets of  $\partial D$ . So we can regard  $\rho$  as a map from a subset of  $\partial D$  to a subset of  $\partial D$ . The content of the *Resident's View of Rational Maps Space* of [31] was essentially that  $\rho$  extends monotonically to  $\partial D$ , with just countably many discontinuities, with continuous inverse on the set

$$\partial_1 = \overline{\rho(\pi_1(V_{3,m}, P_{3,m}, g_0))}.$$

Since  $\pi_1(V_{3,m}, g_0)$  acts naturally on the left of  $\pi_1(V_{3,m}, P_{3,m}, g_0)$ , this action can be transferred using  $\rho$  to one on  $\pi_1(\overline{\mathbb{C}} \setminus Z_m, Z_m, v_2)$ . It can be shown quite easily (1.13 of [31]) that the action is by homeomorphisms of  $\partial D$  which, of course, restrict to homeomorphisms on  $\partial_1$ . The homeomorphisms are lifts of elements of  $\text{MG}(\overline{\mathbb{C}}, Z_m \cup \{v_2\})$ . As a consequence of the Resident's View of Rational Maps Space, the action can be extended (non-canonically) to an action on the Poincaré-metric-convex-hull

$$D' = \text{Conv}(\partial_1) \subset D$$

of  $\partial_1$ , which is conjugate to the action of  $\pi_1(V_{3,m}, g_0)$  on the universal cover of  $V_{3,m}$ . Thus,  $D$  is the universal cover of  $\overline{\mathbb{C}} \setminus Z_m$ , and the universal cover of  $V_{3,m}$  has been identified with a Poincaré-metric-convex subset  $D' = D'(g_0)$  of  $D$ , with the  $\pi_1(V_{3,m}, g_0)$  action transferring to a natural action on the boundary  $\partial D$  of the universal cover of  $\overline{\mathbb{C}} \setminus Z_m$ , and preserving the subset  $\partial D' \cap \partial D = \partial_1$ .

The action of  $\pi_1(V_{3,m}, g_0)$  on  $\pi_1(\overline{\mathbb{C}} \setminus Z_m, Z_m, v_2) \subset \partial D$  has an interpretation in terms of Thurston equivalence. If  $\omega_2 \in \pi_1(V_{3,m}, P_{3,m}, g_0)$  and  $\omega_1 \in \pi_1(V_{3,m}, g_0)$ , and

$$(4.3.1) \quad \beta_1 = \rho(\omega_1), \quad \beta_2 = \rho(\omega_2), \quad \beta_3 = \rho(\omega_1 * \omega_2),$$

$$(4.3.2) \quad [\psi_1] = [\Phi_2(\beta_1)],$$

then (see also 1.13 of [31])

$$(4.3.3) \quad \beta_3 = \beta_1 * \psi_1^{-1}(\beta_2),$$

and hence, using (4.2.1),

$$(4.3.4) \quad \sigma_{\beta_3} \circ g_0 \simeq_{\psi_1} \sigma_{\beta_2} \circ g_0.$$

For later use, it is worth pointing out that (4.3.3) and (4.3.4) also hold if  $\omega_2 \in \pi_1(V_{3,m}, g_0)$ , and we modify the definitions of  $\beta_2$  and  $\beta_3$  and add to them:

$$[\psi_2] = [\Phi_2(\beta_2)].$$

In this case we also have:

$$(4.3.5) \quad \sigma_{\beta_3} \circ g_0 \simeq_{\psi_2 \circ \psi_1} \sigma_{\beta_3} \circ g_0, \quad g_0 \simeq_{\psi_1^{-1} \circ \psi_2^{-1}} \sigma_{\beta_3} \circ g_0.$$

The action of  $\pi_1(V_{3,m}, g_0)$  on  $D$ , regarded as the universal covering space of  $\overline{\mathbb{C}} \setminus Z_m$ , extends to an action of  $\pi_1(B_{3,m}, g_0)$  on  $D$ , which can equally be regarded as an (anti)action of  $\Phi_1(\pi_1(B_{3,m}, g_0))$  or  $\Phi_2(\pi_1(B_{3,m}, g_0))$ . The groups  $G_j = \Phi_j(\pi_1(B_{3,m}, g_0))$  are identified in 4.2 using (4.2.1) and (4.2.2). There is also a natural action of  $\Phi_i(\pi_1(B_{3,m}, g_0))$  on  $\partial D$ , which extends the action of  $\Phi_i(\pi_1(V_{3,m}, g_0))$ ,  $i = 1, 2$ , and is given by the same formulae as in (4.3.1) to (4.3.4).

#### 4.4. Identifying $D'$

The best way to identify  $D'$  of 4.3, and  $\Phi_1(\pi_1(V_{3,m}, g_0))$ , is by identifying  $\partial D' \cap D$ . The boundary is always a union of (Poincaré) geodesics in the *Levy convex hulls*  $C(g_0, \Gamma)$  (3.13 of [31]) of pairs  $(g_0, \Gamma)$  with  $g_0 \in B_{3,m}$ , and for  $\Gamma$  a set of simple loops in  $\overline{\mathbb{C}} \setminus Z_m$ , where  $(g_0, \Gamma)$  satisfies the *Invariance and Levy Conditions* (2.2 of [31]), and is *minimal isometric satisfying the Edge Condition* (Resident's View of Rational Maps Space in 5.10 of [31]). These conditions mean the following.

- $\Gamma$  is a set of simple, non-trivial, non-peripheral, isotopically disjoint and isotopically distinct closed loops in  $\overline{\mathbb{C}} \setminus Y_m$ , such that  $\Gamma \subset g_0^{-1}(\Gamma)$  up to isotopy preserving  $Z_m$ , and every loop in  $g_0^{-1}(\Gamma) \setminus \Gamma$  is either trivial or peripheral in  $\overline{\mathbb{C}} \setminus Z_m$ . This is the *Invariance Condition*.
- Every loop  $\gamma \in \Gamma$  is in the backward orbit of a *Levy cycle*  $\gamma_1, \dots, \gamma_r$  for  $g_0$  and  $\Gamma$ , that is,  $\gamma = \gamma_t$  for some  $t \geq 1$ , and  $\gamma_j \in \Gamma$  for  $1 \leq j \leq t$  with  $\gamma_{j+1} \subset g_0^{-1}(\gamma_j)$  up to  $Z_m$ -preserving isotopy for  $1 \leq j \leq t-1$  and also  $\gamma_1 \subset g_0^{-1}(\gamma_r)$  up to  $Z_m$ -preserving isotopy, and if  $\gamma'_{j+1}$  is the component of  $g_0^{-1}(\gamma_j)$  which is isotopic to  $\gamma_{j+1}$ , and  $\gamma'_1 \subset g_0^{-1}(\gamma_r)$  is similarly defined, then  $g_0|_{\gamma'_k}$  is a homeomorphism for  $1 \leq j \leq k$ . This is the *Levy Condition*.
- Let  $E_2$  denote the component of  $\overline{\mathbb{C}} \setminus (\cup \Gamma)$  containing  $v_2$ . Then the *fixed set*  $P = P(g_0, \Gamma)$  of  $(g_0, \Gamma)$  (see 2.8 of [31]) is either a boundary component of  $E_2$  — and hence in  $\Gamma$  — or is a component of  $\overline{\mathbb{C}} \setminus (\cup \Gamma)$  which is adjacent to  $E_2$ . This is the *minimal condition*. The fixed set  $P$  satisfies a number of conditions:
  - $P$  is not a disc,
  - there is a component  $P_1$  of  $g_0^{-1}(P)$  such that  $P_1 = P$  up to  $Z_m$ -preserving isotopy, and  $g_0|_{P_1}$  is an homeomorphism, reversing orientation if  $P$  is a loop and cyclically permuting boundary components, up to  $Z_m$ -preserving isotopy, if  $P$  is surface (with boundary).
  - The *isometric condition* means that  $g|_{P_1}$  is an isometry, up to isotopy.

In the case of  $B_{3,m}$ , and any pair  $(g_0, \Gamma)$  satisfying the above conditions, the fixed set  $P$  is either a loop or a pair of pants. So the isometric condition is automatic. Now we define the set  $C(g_0, \Gamma)$ . We use the notation of 3.13 of [31]. Let  $\Delta_2$  be the closed disc containing  $E_2$ , with interior disjoint from  $P$ . Then  $\tilde{\Delta}_2$  is the preimage of  $\Delta_2$  in  $D$  with  $\tilde{v}_2 \in \tilde{E}_2$ , where  $\tilde{v}_2$  is a chosen preimage of  $v_2$  in  $D$ , and  $C(g_0, \Gamma)$  is the union of geodesics with the same endpoints as the components of  $\partial\tilde{\Delta}_2$ . Thus,  $C(g_0, \Gamma)$  is a straightening of components of preimages in  $D$  of  $P$  or  $\partial P$ , depending on whether  $P$  is a single loop or a pair of pants which are adjacent to, or in, preimages of  $P$ . There are only two orbits of sets  $C(g_0, \Gamma)$  for  $B_{3,m}$  under the action of  $\pi_1(V_{3,m}, g_0)$  on  $D'$ , because there are only two equivalence classes of loop sets  $(g_0, \Gamma)$  satisfying the Invariance, Levy and Edge conditions, and being minimal and isometric.

So computing  $\partial D'$  means computing sets  $C(g_0, \Gamma)$ , which means computing the fixed sets  $P = P(g_0, \Gamma)$ . Now this is easier if we can ensure that  $\partial\tilde{\Delta}_2$  is not too far from geodesic. This means ensuring that  $P$  or  $\partial P$  is not too far from geodesic in  $\overline{\mathbb{C}} \setminus Z_m$ . We specify to the case  $g_0 = s_q = s$  for some  $q$ , in our case with  $q = \frac{1}{7}$ ,  $\frac{6}{7}$  or  $\frac{3}{7}$ . A simple closed loop in  $\overline{\mathbb{C}} \setminus Z_m$  which has only essential intersections with  $S^1$  can be isotoped, via an isotopy preserving  $S^1$ , to a geodesic. Our set  $P$  might have nonessential intersections because it is defined up to isotopy preserving  $Y_m = Z_m \cup \{v_2\}$ . But then we can choose  $P$  up to isotopy preserving  $Y_m$ , and a closed loop  $\alpha \in \pi_1(\overline{\mathbb{C}} \setminus Z_m, v_2)$  so that  $Q = \sigma_\alpha(P)$  has only essential intersections with  $S^1$ . Our set  $C(s, \Gamma)$  is then a geodesic with the same endpoints as a suitable lift of  $Q$  or  $\partial Q$ , depending on whether  $Q$  is a single loop or a pair of pants. We also have  $Q_1 = Q$  up to isotopy preserving  $Z_m$ , for a suitable component  $Q_1$  of  $s^{-1}(Q)$ . It is a fact that  $\alpha$  is bound to have at least one essential intersection with  $\partial Q$ .

Now this gives a criterion for checking whether  $\beta \in \pi_1(\overline{\mathbb{C}} \setminus Z_m, Z_m, v_2)$  has lift  $\tilde{\beta}$  in  $D'$ . A necessary and sufficient condition for  $\tilde{\beta}$  not to be in  $D'$  is the following *Inadmissibility criterion*.

- There is a pair  $(Q, \alpha)$  as above and such that the following holds. Assume without loss of generality that  $\alpha$  and  $\beta$  have only essential intersections with  $\partial Q$ . Let  $\alpha_1$  be the portion of  $\alpha$  from the start point at  $v_2$  up until the last intersection with  $\partial Q$ . Then there is an initial portion  $\beta_1$  of  $\beta$  such that  $\alpha_1$  and  $\beta_1$  are homotopic via a homotopy fixing the start points at  $v_2$  and keeping the second endpoint in  $\partial Q$ .

This criterion is essentially considered in [30], and we can use the Nonrational Lamination Map Theorem there to check it, using the invariant lamination  $L_\beta$  defined in 4.2. In our case, this criterion involves analyzing the leaves of  $L_\beta$  which have period two or three, and determining whether the closure of their union can be homotopic to a set such as  $Q$ . There are very few such periodic leaves, and therefore not much to

check. This inadmissibility criterion is a generalization of the criterion for a mating to be not Thurston equivalent to a rational map [38], and the results about Thurston equivalence of capture to rational maps, quoted in 2.6, can be easily derived from it.

### 4.5. The arc set $\Omega_0$ and the image under $\rho$

We consider the picture of  $V_3$  with an arc set  $\Omega_0$ :

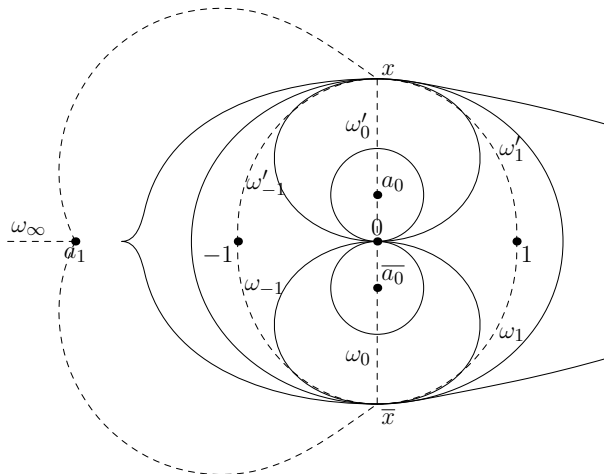

$V_3$  and  $\Omega$

The paths  $\omega_\infty, \omega_0, \omega_1$  and  $\omega_{-1}$  — which are, in fact, arcs — all start from  $a_1$  and end at the points  $\infty$  (the straight line path  $\omega_\infty$  heading to the left),  $\pm 1$  and  $0$ , and are in the closed lower half-plane. The paths  $\omega_0, \omega_1$  and  $\omega_{-1}$  all run close to the same path from  $a_1$  to  $x$ , which is a path in the hyperbolic component of  $h_{a_1}$ . The paths from near  $\bar{x}$  to  $\pm 1$  are then within the hyperbolic components of  $h_{\pm 1}$  respectively. The path from  $\bar{x}$  to  $0$  passes through  $\bar{a}_0$  and is always in a copy of the Mandelbrot set, corresponding to matings (2.6) of quadratic polynomials in the Mandelbrot set, minus a limb, with  $h_{\bar{a}_0}$ . We also define paths  $\omega'_0, \omega'_1$  and  $\omega'_{-1}$ , which are simply the complex conjugates of the paths  $\omega_0, \omega_1$ , and  $\omega_{-1}$ . We write  $\omega'_i$  for the conjugate of  $\omega_i$ , which is an arc of  $\Omega'_0$ , since, if  $\beta$  is a path  $\bar{\beta}$  is our notation for the reverse of  $\beta$ , and we shall be using this notation. Note that  $\omega'_\infty = \omega_\infty$ .

Now we describe  $\rho(\omega, s_{3/7})$  for each of  $\omega = \omega'_{\pm 1}, \omega_{\pm 1}, \omega_\infty$ . The path  $\rho(\omega_\infty)$  is a bit different from the others because its second endpoint is not at a point of  $Z_0(s_{3/7})$ , but on a closed loop which is itself only defined up to isotopy relative to  $Z_m(s_{3/7})$ . This closed loop cuts the unit disc at precisely two points,  $e^{\pm 2\pi i(3/7)}$ . Recall that the path  $\omega_\infty$  was along the negative real axis. It is not possible to represent  $\rho(\omega_\infty)$  by a path along the real axis without hitting  $Z_m(s_{3/7})$  (even if  $m = 0$ ), so a choice of representative has been made, which meets the closed loop  $\gamma$  at  $e^{-2\pi i(3/7)} = e^{2\pi i(4/7)}$ . Other

possible representatives of  $\rho(\omega_\infty)$  are obtained from the chosen representative by homotopy keeping  $Z_m(s_{3/7})$  fixed, and keeping the second endpoint on  $\gamma$ . So moving along  $\gamma$  outside the unit disc, another possible representative of  $\rho(\omega_\infty)$  is the complex conjugate of the path drawn.

The picture is as follows. The unit circle and some lamination leaves of  $L_{3/7}$  are indicated by dashed lines

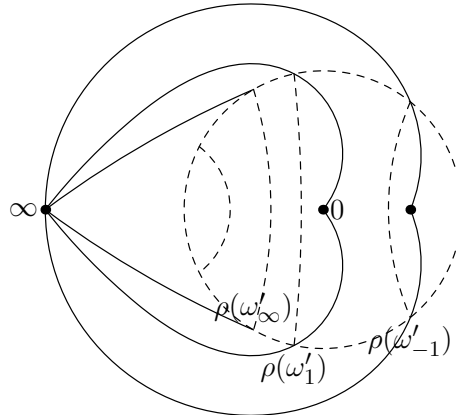

Image under  $\rho(\cdot, s_{3/7})$

The images under  $\rho$  of  $\omega'_{\pm 1}$  and  $\omega'_\infty$  have been drawn with solid lines and labelled, but not  $\omega'_0$ , because the regions  $V_3(a_0)$  and  $V_3(\bar{a}_0)$  are best described using  $\rho(\cdot, s_{1/7})$  or  $\rho(\cdot, s_{6/7})$ . (The images under  $\rho$  of  $\omega_{\pm 1}$  and  $\omega_\infty$  have also been drawn, with solid lines, but not labelled.) The pictures are correct up to isotopy preserving  $Z_m(s)$  for any  $m \geq 0$ . To see that this is the correct picture, we just consider  $\rho(\omega'_1, s_{3/7})$  since the other cases are exactly similar. Apart from one common boundary point between hyperbolic components, the path  $\omega'_1$  is entirely in  $H_{a_1} \cup H_1$ . The common boundary point represents the parabolic point on  $\partial H_a$ , where the centre of  $H_a$  is Thurston equivalent to  $s_{3/7} \amalg s_{1/7}$ , this boundary point also being in  $\partial H_{a_1} \cap \partial H_1$ . If we parametrise  $\omega'_1$  by  $t \in [0, 1]$  with  $\omega'_1(0) = a_1$  and  $\omega'_1(1) = 1$ , then we can choose  $\omega'_1$  in its homotopy class so that  $\omega'_1(\frac{1}{2})$  is the parabolic parameter value which is a common boundary point, and for all  $t < \frac{1}{2}$  or  $t = \frac{1}{2}$  or  $t > \frac{1}{2}$  respectively,  $v_2(\omega'_1(t))$  is in the fixed attractive basin of  $h = h_{\omega'_1(t)}$ , or in the parabolic basin of  $c_1(h_{\omega'_1(t)})$ , or in the attractive basin of  $c_1(h_{\omega'_1(t)})$ . We then see that  $\rho(\omega'_1, s_{3/7}) = \beta_{5/7}$ , as shown in the figure, and this realizes the Thurston equivalence between  $h_1$  and the type II capture  $\sigma_{5/7} \circ s_{3/7}$  defined in 2.7.

Now we describe parts of the domain of the maps  $\rho(\cdot, s_{1/7})$  and  $\rho(\cdot, s_{6/7})$ . Recall that the arcs  $\omega'_0$  and  $\omega'_{\pm 1}$  run close to a common path until they reach the upper-half-plane common boundary component  $x$  of the hyperbolic components containing  $\pm 1$ . A similar statement holds for  $a_0$  and  $x$  replaced by  $\bar{a}_0$  and  $\bar{x}$ , and with  $\omega'_{\pm 1}$  and

$\omega'_0$  replaced by  $\omega_{\pm 1}$  and  $\omega_0$ . Now we take adjustments  $\omega'_{0,a_0}$  and  $\omega'_{\pm 1,a_0}$  of the arcs  $\omega'_0$  and  $\omega'_{\pm 1}$ , arcs in  $V_{3,0}$  which all start at  $a_0$ , because we shall want to determine other arcs by their images under  $\rho(\cdot, s_{1/7})$ . To do this, we simply choose an arc  $\gamma'_0$  from  $a_0$  to  $a_1$ , and define  $\omega_{i,a_0}$  to be  $\gamma'_0 * \omega'_i$ , as an element of  $\pi_1(V_{3,0}, P_{3,0}, \overline{a_0})$ . So it remains to define  $\gamma'_0$ , as an element of  $\pi_1(V_{3,0}, a_1, a_0)$ . Note that we can then take  $\omega'_{0,a_0}$  to lie in the hyperbolic component of  $h_{a_0}$ , except for the endpoint at 0, and we shall do so.

The arc  $\gamma'_0$  can be determined up to isotopy in  $V_{3,m}$ , for any  $m$ , by describing the image of the reverse path  $\overline{\gamma'_0}$  under  $\rho(\cdot, s_{3/7})$  up to isotopy preserving  $Y_m(s_{3/7})$  for any  $m$ . Even though  $\overline{\gamma'_0}$  is not in the domain of  $\rho(\cdot, s_{3/7})$  as previously defined, any path in  $V_{3,m}$  between  $a_1$  and either  $a_0$  or  $\overline{a_0}$  does determine an element  $[\beta]$  of  $\pi_1(\overline{\mathbb{C}} \setminus Z_m(s_{3/7}), \infty)$ , and a Thurston equivalence

$$s_{3/7} \simeq \sigma_\beta \circ s_{3/7}.$$

The figure in 3.1 should help: this figure gives two invariant circles under  $s_{3/7} \amalg s_{1/7}$ , the usual unit circle being  $\gamma_1$  and the other being  $\gamma_2$ , which is drawn up to isotopy preserving  $Y_0(s_{3/7})$  in the figure. Up to isotopy preserving  $Y_0(s_{3/7})$ , the path  $\rho(\overline{\gamma'_0}, s_{3/7})$  crosses both  $\gamma_1$  and  $\gamma_2$  between  $e^{2\pi i(5/7)}$  and  $e^{2\pi i(6/7)}$ , and has no further crossings with  $\gamma_2$  before returning to  $v_2$ . We simply refine this description to give  $\rho(\overline{\gamma'_0}, s_{3/7})$  up to isotopy preserving  $Y_m(s_{3/7})$ : just one essential crossing with  $\gamma_2$ . It follows that  $\rho(\overline{\gamma'_0} * \omega'_{i,a_0}, s_{3/7})$  also just has one essential crossing with  $\gamma_2$ , for  $i = \pm 1$ , and hence  $\rho(\omega'_{i,a_0}, s_{1/7})$  has just one crossing with the unit circle. Examining the diagram in 2.10, we see that the crossing is at  $e^{2\pi i(4/7)}$ , up to isotopy preserving  $Z_m(s_{1/7})$ , for any  $m$ . Write  $\beta_{p,x}$  for an arc from  $v_2 = \infty$  to  $x$ , which crosses the unit circle only at  $e^{2\pi i(p)}$ , passing from there into the gap of  $L_{1/7}$  containing  $x$ , for  $x = c_1$  or  $s_{1/7}(v_1)$  and  $p = 1/7$  or  $2/7$  or  $4/7$ . Then we have shown that

$$(4.5.1) \quad \rho(\omega'_{1,a_0}, s_{1/7}) = \beta_{4/7, c_1}, \quad \rho(\omega'_{-1,a_0}, s_{1/7}) = \beta_{4/7, s(v_1)}.$$

We write  $\beta_{4/7, c_1, s_{1/7}(v_1)}$  for an arc joining  $c_1 (= 0)$  and  $s_{1/7}(v_1)$ , passing between the gaps containing  $c_1$  and  $s_{1/7}(v_1)$  via the common boundary point  $e^{2\pi i(4/7)}$ . Then it follows immediately from (4.5.1) that

$$(4.5.2) \quad \overline{\rho(\omega'_{1,a_0}, s_{1/7})} * \rho(\omega'_{-1,a_0}, s_{1/7}) = \beta_{4/7, c_1, s(v_1)}.$$

Similar formulae to (4.5.1) and (4.5.2) hold for  $\overline{a_0}$  and  $s_{6/7}$  replacing  $a_0$  and  $s_{1/7}$ , for loops  $\omega_{i, \overline{a_0}} = \gamma_0 * \omega_i$ , for  $\gamma_0$  defined similarly to  $\gamma'_0$ . Even without the precise definition of  $\gamma'_0$  given above, it is true that the homotopy class of the arc  $\overline{\omega'_{-1,a_0}} * \omega'_{1,a_0}$  is uniquely determined in  $V_{3,m}$ , up to homotopy fixing endpoints, but one cannot canonically define the image under  $\rho$  of  $\overline{\omega'_{-1,a_0}} * \omega'_{1,a_0}$ .

We also define two more arcs  $\omega'_{0, \pm 1, a_0}$  from  $a_0$  to  $\pm 1$ , by taking a path close to  $\omega'_{0,a_0}$  followed by an arc in  $H_{\pm 1}$ . So these arcs can be taken to lie in the union of the hyperbolic component of  $h_{a_0}$  and either  $H_1$  or  $H_{-1}$ , apart from arbitrarily small



neighborhoods of 0. So the arcs  $\omega'_{0,a_0}$  and  $\omega'_{0,\pm 1,a_0}$  are uniquely determined as elements of  $\pi(V_{3,m}, P_{3,m}, a_0)$ , for any  $m$ . We write  $\beta_{1/7,c_1}$  for an arc from  $v_2 = \infty$  to  $c_1$ , which crosses the unit circle only at  $e^{2\pi i(1/7)}$ , passing from there into the gap containing  $c_1$ , and similarly for  $\beta_{2/7,s(v_1)}$ , which crosses the unit circle at  $e^{2\pi i(2/7)}$ , passing into the gap containing  $s_{1/7}(v_1)$ . Then the homotopy classes of these two paths in  $\overline{\mathbb{C}} \setminus Z_m(s_{1/7})$  are uniquely determined. Now  $\omega'_{0,1,a_0}$  is an arc in  $H_{a_0} \cup H_1$ , apart from an arbitrarily small neighborhood of 0, which is a deleted common boundary point, while  $\beta_{1/7,c_1}$  is the path defining the corresponding type II capture, and similarly with 1 replaced by  $-1$ . So

$$(4.5.3) \quad \rho(\omega'_{0,1,a_0}, s_{1/7}) = \beta_{1/7,c_1}, \quad \rho(\omega'_{0,-1,a_0}, s_{1/7}) = \beta_{2/7,s_{1/7}(v_1)}.$$

It therefore makes sense to use  $\rho(\cdot, s_{3/7})$  to describe  $V_{3,m}(a_1, \pm)$ , to use  $\rho(\cdot, s_{1/7})$  to describe  $V_{3,m}(a_0)$ , and to use  $\rho(\cdot, s_{6/7})$  to describe  $V_{3,m}(\overline{a_0})$ .



## CHAPTER 5

### FUNDAMENTAL DOMAINS

#### 5.1. Fundamental domains: a restricted class

The proof of Theorem 2.10 is simply the construction of a fundamental domain for the action of  $\pi_1(V_{3,m})$  on  $D'$ . In this section we consider the general problem of constructing a fundamental domain for the action of a finitely-generated discrete group  $\Gamma$  of Möbius transformations, acting freely on the open unit disc  $D$ . We specialize to  $V_{3,m}$  in 5.4. We are interested in fundamental domains only up to homeomorphism. Then  $F \subset D$  is a *fundamental domain* for  $\Gamma$  if

$$D = \cup\{\gamma.F : \gamma \in \Gamma\},$$

and  $\gamma.\text{int}(F) \cap \text{int}(F) = \emptyset$  for all  $\gamma \neq \text{identity}$ ,  $\gamma \in \Gamma$ . A fundamental domain always exists. If  $\Gamma$  is a free group, and has at least one parabolic element,  $D/\Gamma$  is known to be a compact surface minus at least one puncture, and so  $\Gamma$  is a free group containing parabolic elements. Then we can, and do, choose  $F$  bounded by finitely many smooth arcs with both ends at lifts of punctures, with  $\overline{F}$  intersecting  $\partial D$  only in lifts of parabolics. We shall give a vague restatement of the Main Theorem 2.10 in 5.7, and refine this, in restatements in two separate cases, in 6.1, 7.11.

#### 5.2. Fundamental Domains: construction from graphs and from matching pairs of adjacent path pairs

The union of the punctures and the projection of  $\partial F$  to  $D/\Gamma$  is a graph whose complement is a topological disc. Conversely, let  $G$  be any graph in  $V = D/\Gamma$  which is a union of smooth arcs and such that, allowing vertices at punctures, the complement is a topological disc. Then any component of the lift to the universal cover of the complement of  $G$  is a fundamental domain for  $\Gamma$ .

Let  $P$  denote the set of punctures of  $V = D/\Gamma$ , and fix a basepoint  $x_0 \in V$ . Then another equivalent way of choosing a fundamental domain with vertices at lifts of

punctures is to choose a set of arcs  $\Omega$  from  $x_0$  to  $P$ , such that the interiors of the arcs are disjoint and they all represent distinct elements of  $\pi_1(V, P, x_0)$ , such that each component  $U$  of  $V \setminus \cup \Omega$  is bounded by either three or four arcs of  $\Omega$ , and is disjoint from  $P$ , but has exactly two points of  $P$  in its boundary, provided that  $\#(P) > 2$ , as we are assuming. Here is an example. The arcs of  $\Omega$  are shown as solid lines, and the edges of the corresponding graph  $G_\Omega$  – which is a tree – by dashed lines. In this rather small example, there is just one component of  $V \setminus \cup \Omega$  which has four arcs of  $\Omega$  in its boundary. All the other components have just three arcs.

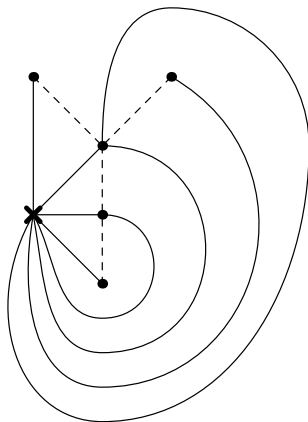

An example of a graph

There is exactly one edge of  $G_\Omega$  in each component  $U$  of  $V \setminus \cup \Omega$ , joining the unique pair of points in  $P \cap \partial U$ , and these are all the edges of  $G_\Omega$ . Two of the arcs of  $\Omega$  in  $\partial U$  are accessible from each side of  $e(U)$  in  $U$ . This gives two pairs of arcs  $(\omega_1, \omega_2)$ ,  $(\omega'_1, \omega'_2)$ , in no specified order, such that one pair is accessible from  $U$  from one side of  $e(U)$  and the other pair from the other side. One of the arcs  $\omega_1, \omega_2$  might coincide with one of  $\omega'_1, \omega'_2$  but at least three of the arcs are distinct and these comprise all the arcs of  $\Omega$  in  $\partial U$ . We call such a pair of pairs  $((\omega_1, \omega_2), (\omega'_1, \omega'_2))$  a *matching pair of adjacent pairs*. Note that  $\omega_1$  and  $\omega_2$  are indeed adjacent in  $\Omega$ , and similarly for  $\omega'_1$  and  $\omega'_2$ . By this we mean the following. Take lifts of all arcs in  $\Omega$  to the universal cover, with lifts all starting from the same pre-image  $\tilde{x}_0$  of  $x_0$ . Let  $\tilde{\omega}$  denote the lift of  $\omega$  and  $\tilde{\Omega} = \{\tilde{\omega} : \omega \in \Omega\}$ . Then  $\omega_1$  and  $\omega_2$  are said to be adjacent in  $\Omega$  if  $\tilde{\omega}_1$  and  $\tilde{\omega}_2$  are not separated by any other arc in  $\tilde{\Omega}$ . We can use this concept of adjacency if  $\Omega$  is any subset of  $\pi_1(V, P, x_0)$ , not necessarily a set of disjoint arcs. Conversely, to construct  $\Omega = \Omega_G$  from  $G$ , we need  $x_0 \notin G$ , and we then take  $\Omega$  to be the set of arcs, starting from  $x_0$  and which, up to homotopy, intersect  $G$  only at endpoints in  $P$ , with one path ending at each sector of the complement of  $G$ , at each point of  $P$ . The set of matching pairs of adjacent pairs in  $\Omega$  is then determined from  $G$  as above. Any adjacent pair in  $\Omega$  does occur as one of a matching pair of adjacent pairs

for exactly one edge, and is thus matched with exactly one other adjacent pair. The correspondence  $G \mapsto \Omega$  is therefore a bijection.

Given a fundamental domain  $F$  for some group  $\Gamma$  which has all vertices on  $\partial D$ , and given a vertex  $v$  of  $F$ , we can define the *group element of  $v$*  to be the product  $g_r \cdots g_1$  defined as follows. Put an anticlockwise orientation on  $\partial F$  round  $F$ . Let  $\ell_1$  be the geodesic in  $\partial F$  starting at  $v$ . Now inductively define a finite sequence of geodesics  $\ell_i$  in  $\partial F$ , and group elements  $g_i \in \Gamma \setminus \{1\}$ , such that  $g_i \ell_i$  is also in  $\partial F$ . Thus  $\ell_i$  uniquely determines  $g_i$ . Note that each  $g_i : \ell_i \rightarrow g_i \ell_i$  reverses orientation. The inductive definition of  $\ell_{i+1}$  is that  $\ell_{i+1}$  is the geodesic which starts at the vertex where  $g_i \ell_i$  finishes. Thus,  $\ell_{i+1}$  starts at the vertex  $g_i \cdots g_1 v$ . We take  $r$  to be the least integer such that  $\ell_{r+1} = \ell_1$ , equivalently, the least integer such that  $g_r \cdots g_1 v = v$ . Then  $g_r \cdots g_1$  is automatically parabolic.

Let  $F$  be a fundamental domain in  $D$ ,  $G$  the corresponding graph in the quotient space  $V$  with puncture set  $P$ ,  $\Omega \subset \pi_1(V, x_0, P)$  the corresponding arc set. Let  $A \subset \pi_1(V, x_0)$  be the set of elements  $g$  such that  $g.F$  has a common edge with  $F$ . Then  $A = A^{-1}$  generates  $\pi_1(V, x_0)$ . The elements of  $A$  are in one-to-one correspondence with the edges of  $F$ , in two-to-one correspondence with the edges of  $G$ , with the two elements associated to an edge  $e$  being of the form  $g^{\pm 1}$ , and in one-to-one correspondence with ordered matched pairs of adjacent pairs of elements of  $\Omega$ . This is the set of all  $(\omega_1, \omega_2, \omega'_1, \omega'_2)$ , where  $\omega_1$  and  $\omega_2$  are adjacent in  $\Omega$  with  $\omega_2$  anticlockwise from  $\omega_1$ , and  $\omega'_1$  and  $\omega'_2$  are adjacent in  $\Omega$  with  $\omega'_2$  clockwise from  $\omega'_1$ , and  $\omega_i$  and  $\omega'_i$  end at the same point of  $P$  for  $i = 1, 2$ , and the disc with anticlockwise boundary made up of  $\omega_1, \overline{\omega_1}, \omega'_2, \overline{\omega'_2}$  is disjoint from  $P$ . The corresponding element of  $A$  then satisfies  $g.\omega_i = \omega'_i$  for  $i = 1, 2$ , using the usual action of  $\pi_1(V, x_0)$  on  $\pi_1(V, x_0, P)$ . There is only one such element  $g \in \pi_1(V, x_0)$ . For suppose there are two such,  $g_1$  and  $g_2$ . Then  $g_2^{-1}g_1 \neq 1$  fixes the geodesic in  $D$  which is the side of  $F$  joining the endpoints of lifts of  $\omega_1$  and  $\omega_2$ . It also fixes the endpoints. But there are also parabolic elements of  $\pi_1(V, x_0)$  fixing these endpoints. For a discrete group of hyperbolic isometries, this is impossible.

The vertex group elements can then be computed from the set of matching pairs of adjacent pairs, and the group elements matched pairs, by taking a cycle  $(\omega_1, \omega_2, \omega'_1, \omega'_2), (\omega'_1, \omega'_3, \omega''_1, \omega''_2) \dots$  and taking the product of group elements for each successive matching pair of adjacent pairs in the cycle.

### 5.3. Examples of Fundamental domains: the graph from a Julia set

In this paper, we are concerned with the punctured spheres  $V_{3,m}$ . As we have seen, this means we are also interested in the punctured sphere  $\overline{\mathbb{C}} \setminus Z_m(g_0)$  for various maps  $g_0 \in B_{3,m}$ , special consideration being given to the maps  $g_0 = s_p$  for  $p = \frac{1}{7}$ ,

$\frac{6}{7}, \frac{3}{7}$ . A simple way to construct a fundamental domain  $F$  for  $\overline{\mathbb{C}} \setminus Z_m(s_p)$ , or, more accurately, for its fundamental group, is to take as the graph  $G$  the tree  $T_m(s_p)$  which has as vertices the points of  $Z_m(s_p)$ , and is defined as follows. Two points  $z_1$  and  $z_2 \in Z_m(s_p)$  are joined by an edge in  $T_m(s_p)$  if and only if the gaps  $G_1$  and  $G_2$  of  $L_p$  containing them are adjacent in the unit disc, that is, not separated by any other gap containing a point of  $Z_m(s_p)$ , and either one of  $G_1$  or  $G_2$  is the gap containing the critical value, or separates the other one from this gap. Then all edges are taken in the unit disc and transverse to  $L_p$ . This completely determines  $T_m(s_p)$ , up to isotopy. Then  $T_m(s_p)$  determines an arc set, together with a matching of pairs of adjacent pairs. This example will be important when we come to restate our main theorem 2.10 in 5.7, 6.1, 7.11.

#### 5.4. Fundamental domain for the whole group

The following gives a sufficient condition for a subset  $F$  of the unit disc, with a pairing of edges via elements of  $\Gamma$ , to be a fundamental domain for a group  $\Gamma$ , rather than for a subgroup of  $\Gamma$ . The lemma implies that, in order to construct a fundamental domain for  $V$ , we only need to find  $\Omega \subset \pi_1(V, P, x_0)$ , together with a set of matching pairs of adjacent pairs, such that each adjacent pair is matched to exactly one other, such that the vertex elements are all parabolic, and a rather mild extra condition. We do not need to know that the elements of  $\Omega$  are all represented by arcs in  $V$ . That is a consequence, but not a prior condition. The construction of  $F$  from  $\Omega$  in 4.2 uses lifts of  $\Omega$  from a chosen lift  $\tilde{x}_0$  of  $x_0$ . The lifts of paths in  $\Omega$  emanating from  $\tilde{x}_0$  are homotopic to geodesic rays in  $D$ , whether or not the original paths in  $\Omega$  are arcs.

**Lemma** *Let  $\Gamma$  be a discrete group of Möbius transformations acting on the unit disc  $D$ . Let  $F$  be a topological disc in  $D$  bounded by  $2r$  geodesics  $\ell_i$  ( $1 \leq i \leq r$ ) and  $\gamma_i \cdot \ell_i$ , where  $\gamma_i \in \Gamma$ , each  $\ell_i$  has endpoints at parabolic points of  $\Gamma$ , and  $\gamma_i \cdot F \cap F = \emptyset$ . Then  $F$  is a fundamental domain for a finite index subgroup  $\Gamma_1$  of  $\Gamma$ , which is a free group on the  $r$  generators  $\gamma_i$ .*

*If, in addition, for each vertex  $v$  of  $F$ , the group element of the vertex is a parabolic representing a puncture of  $D/\Gamma$ , and either  $D/\Gamma$  is a punctured sphere, or at least one puncture on  $D/\Gamma$  is represented by only one  $\Gamma_1$ -conjugacy-class of a group element of a vertex of  $F$ , then  $F$  is a fundamental domain for  $\Gamma$ .*

*Proof.* – Let  $\Gamma_1$  be the group generated by  $\gamma_i$  for  $1 \leq i \leq r$ . Let  $w, w'$  be any two words in  $\gamma_i^{\pm 1}$  for  $1 \leq i \leq r$  in which  $\gamma_i$  and  $\gamma_i^{-1}$  are never adjacent. Then by induction,  $w \cdot F$  and  $w' \cdot F$  are disjoint if  $w \neq w'$ . In fact  $w \cdot F$  and  $w' \cdot F$  are separated by  $w'' \cdot F$ , where  $w''$  is the longest common prefix (possibly trivial) of  $w$  and  $w'$ , unless one of  $w, w'$  is a prefix of the other. If  $w$  is a prefix of  $w'$ , then  $w \cdot F$  and  $w' \cdot F$  are adjacent

if  $w'$  has one more letter than  $w$ , and separated by  $w'' \cdot F$  if  $w'$  has at least two more letters than  $w$ , and  $w''$  is the prefix of  $w'$  which has one more letter than  $w$ . So  $\Gamma_1$  is a free group, and discrete, since it is a subgroup of  $\Gamma$ . Now we claim that  $D = \Gamma_1 \cdot F$ . If not, then there is some sequence  $w_n$  of increasing words in  $\{\gamma_i^{\pm 1} : 1 \leq i \leq r\}$  such that  $w_n \cdot F$  does not converge to a point. Now the minimum distance of  $F$  from  $w \cdot F$  is bounded from 0 unless  $w = \gamma_i^m$  for some  $1 \leq i \leq r$  and some  $m \in \mathbb{Z}$ . So the increasing sequence of words  $w_n$  must be of the form  $w_k \gamma_i^{\pm(n-k)}$  for some  $w_k$  and  $\gamma_i$ . But for such a sequence,  $w_n \cdot F$  converges to a point. So now  $D = \Gamma_1 \cdot F$ , and since  $F$  has finite area,  $\Gamma_1$  must be of finite index in  $\Gamma$ .

If  $\Gamma_1 \neq \Gamma$ , then  $D/\Gamma_1$  is a finite cover of  $D/\Gamma$ . We call the covering map  $\pi$ . If the group element of each vertex of  $F$  is a simple parabolic element of  $\Gamma$ , then we can fill in punctures to obtain closed surfaces  $S_1$  and  $S$  with marked points, and we can extend  $\pi$  to a covering map  $\pi : S_1 \rightarrow S$ , such that marked points map to marked points, and the inverse image of every marked point of  $S$  is a marked point of  $S_1$ . If we have an  $n$ -fold covering for  $n > 1$ , then each marked point on  $S$  has  $n$  preimages in  $S_1$ , and  $\chi(S_1) = n\chi(S)$ , where  $\chi$  denotes Euler characteristic. So we must have  $\chi(S) \leq 0$ , and  $S$  cannot be a sphere, We must have  $n = 1$  if some puncture is represented by only one  $\Gamma_1$  conjugacy class of a group element of a vertex of  $F$ . □

### 5.5. Fundamental domains for increasing numbers of punctures

Let  $V$  be a surface with a finite puncture set  $P$ . Now let  $Q \subset V$  be a finite set with  $P \subset Q$ . Let  $F_P$  be a fundamental domain for  $V \setminus P$  with all vertices at  $P$ . Then we can choose a fundamental domain for  $V \setminus Q$  by the following procedure. We can regard  $F_P$  as a topological disc in  $V$ , and after homotopy on the boundary, we can assume that  $\partial F_P \cap Q = \emptyset$ . Fix  $x_0 \in V \setminus \partial F_P$ . We have a graph  $G_P$  and set  $\Omega_P$  of arcs from  $x_0$  to  $P$ , derived from  $F_P$ , as explained in 5.2. We also have matching pairs of adjacent pairs in  $\Omega_P$ , as explained in 5.2. Let  $((\omega_1, \omega_2), (\omega'_1, \omega'_2))$  be any matching pair of adjacent pairs in  $\Omega_P$ . Then up to homotopy,  $\omega_1 \cup \omega_2 \cup \omega'_1 \cup \omega'_2$  bounds a topological disc  $U$  in  $V$ , containing a single edge  $e(U)$  of the graph  $G_P$ , which is also the projection of two matched edges of  $F_P$ . We then modify  $F_P$  to a fundamental domain  $F_Q$  for  $V \setminus Q$ , by changing  $e(U)$ , for each such  $U$ , to a tree  $G(e(U)) \subset U \cup \text{ends}(e(U))$ , satisfying the following properties:

- $G(e(U))$  is a tree which is contained in  $U$  apart from the two ends of  $e(U)$ , which are extreme vertices of  $G(e(U))$ ;
- the other vertices of  $G(e(U))$  are all the points of  $Q$  in  $U$ .

The graph  $G_Q$  is the union of all the trees  $G(e(U))$ . Then  $G_Q$  determines a fundamental domain for  $V \setminus Q$ . The arc set  $\Omega_Q$  contains  $\Omega_P$  up to homotopy. Each matching

pair of adjacent pairs is contained in  $U \cup \omega_1 \cup \omega_2 \cup \omega'_1 \cup \omega'_2$  for some  $((\omega_1, \omega_2), (\omega'_1, \omega'_2))$  and  $U$  as above.

Let  $K$  be the kernel of the forgetful homomorphism  $\pi_1(V \setminus Q) \rightarrow \pi_1(V \setminus P)$ . Each edge  $e$  of  $G_P$  has two lifts in  $\partial F_P$ , which are identified by  $g_e \in \pi_1(V \setminus P)$ . The element  $g_e$  is unique up to replacing it by its inverse. Let  $e'$  be an edge of  $G(e) \subset G_Q$ . If one end of  $e'$  is an extreme vertex of  $G(e)$ , that is, not an end of any other edge of  $G_Q$ , then  $g_{e'} \in K$ . Otherwise,  $e'$  extends to a path in  $G(e)$  between the endpoints of  $e$ , this path being unique up to homotopy in  $G(e)$ , and  $g_{e'}$  projects under the forgetful homomorphism to  $g_e$  or  $g_e^{-1}$ .

Let  $\Sigma_P$  be the (finite disjoint) union of all sets  $U$  for  $F_P$ , as above. Each  $\partial U$  is the union of two arcs  $\overline{\omega_1} * \omega_2$  and  $\overline{\omega'_1} * \omega'_2$ . If we have a sequence of fundamental domains  $F_m$ , with each  $F_{m+1}$  constructed from  $F_m$  as  $F_Q$  is constructed from  $F_P$  above, then we get a sequence of sets  $\Sigma_m$ .

Topological discs of the type  $U \subset V \setminus P$  will play an important role in the construction of the fundamental domain for  $V_{3,m}$ . Let  $K$  denote the kernel of the forgetful homomorphism  $\pi_1(V \setminus Q) \rightarrow \pi_1(V \setminus P)$ . Then  $\partial U$  represents a conjugacy class in  $K$ , if we perturb  $U$  isotopically to a set disjoint from  $P$ , inside the original  $U$ . For then  $\partial U$  is a simple loop which bounds a loop disjoint from  $P$ , but possibly not disjoint from  $Q$ . Now  $\pi_1(V \setminus Q)$  acts on  $D$ , and the quotient space  $D/K$  is homeomorphic to a punctured disc, on which  $\pi_1(V \setminus P) \cong \pi_1(V \setminus Q)/K$  acts. Filling in the punctures, we obtain the universal cover of  $V \setminus P$ , which is again the unit disc  $D$  up to conformal isomorphism, and the canonical action of  $\pi_1(V \setminus P)$  on  $D$ . Any lift  $\tilde{U}_1$  of  $U$  to  $D/K$  projects homeomorphically to  $U$  and any two distinct lifts  $\tilde{U}_1$  and  $\tilde{U}_2$  are disjoint, but in the same orbit under the action of  $\pi_1(V \setminus Q)/K$ . Any two lifts  $\tilde{U}_1$  and  $\tilde{U}_2$  of  $U$  to the universal cover  $D$  of  $\pi_1(V \setminus Q)$  are either equal or disjoint, with  $\tilde{U}_2 = g \cdot \tilde{U}_1$  for at least one  $g \in \pi_1(V \setminus Q)$ . The stabiliser of  $\tilde{U}_1$  in  $\pi_1(V \setminus Q)$  is a subgroup of  $K$ .

## 5.6. Specifying to $V_{3,m}$

To construct a fundamental domain  $F_{m+1}$  for  $V_{3,m+1}$  from a fundamental domain  $F_m$  for  $V_{3,m}$ , we shall use the procedure outlined in 5.5, constructing a fundamental domain for  $V_{3,m+1}$  from a fundamental domain for  $V_{n,m}$ . This means that we start with a fundamental domain for  $V_{3,0}$ . By 5.2, this is equivalent to having a set  $\Omega_0 \subset \pi_1(V_{3,0}, a_1, P_{3,0})$  with matching pairs of adjacent pairs. We use the set  $\Omega_0$  of 4.5.

Again, by 5.2, the construction of a fundamental domain for  $V_{3,m}$  is equivalent to constructing an arc set  $\Omega_m$  with similar properties, with matching pairs of adjacent pairs. Note that we do not need to know that  $\Omega_m$  is a set of disjoint arcs, if we can deduce it later on, using the lemma in 5.4. So we only need a set of paths  $\Omega_m \subset \pi_1(V_{3,m}, a_1, P_{3,m})$  such that the vertex group elements of the fundamental domain (a



priori a fundamental domain for a subgroup: see 5.4) are all simple parabolics, that is, representing paths which go once round punctures of  $V_{3,m}$ . We shall define

$$\Omega_m = \{\gamma'_0 * \omega : \omega \in \Omega_m(a_0)\} \cup \{\gamma_0 * \omega : \omega \in \cup \Omega_m(\overline{a_0})\} \cup \Omega_m(a_1, -) \cup \Omega_m(a_1, +),$$

where  $\gamma'_0$  and  $\gamma_0$  are as in 4.5. The set  $\gamma'_0 * \Omega_m(a_0)$  will consist of the paths of  $\Omega_m$  with endpoints in  $P_m(a_0)$ , and the paths of  $\Omega_m(a_0)$  will have endpoints in  $P_m(a_0)$ , and otherwise lie entirely in  $V_{3,m}(a_0)$ . Similar properties hold for  $\gamma_0$  and  $\Omega_m(\overline{a_0})$ . The paths of  $\Omega_m(a_1, -)$  will have endpoints in  $P_{3,m}(a_1, -)$ , and otherwise lie entirely in  $H_1 \cup \{x, \bar{x}\} \cup V_{3,m}(a_1, -)$  and similarly for  $\Omega_m(a_1, +)$ . We shall construct  $\Omega_m(a_0)$  by constructing the image under  $\rho(\cdot, s_{1/7})$ , and  $\Omega_m(\overline{a_0})$  by constructing the image under  $\rho(\cdot, s_{6/7})$  and  $\Omega_m(a_1, \pm)$  by constructing the images under  $\rho(\cdot, s_{3/7})$ . The sets  $\Omega_m(a_0)$ ,  $\Omega_m(\overline{a_0})$ , and  $\Omega_m(a_1, -)$  will be constructed in Section 6, and the sets  $\Omega_m(a_1, +)$  will be constructed in Section 7.

Now provided we know that  $\rho(\Omega_m(a_0), s_{1/7}) \subset D'$  for  $D' = D'(s_{1/7})$  as in 4.3, and similarly for  $\Omega_m(\overline{a_0})$  and  $\Omega_m(a_1, \pm)$ , the Resident's View implies that adjacency of paths in  $\Omega_m$  transfers under  $\rho$ . We need to use  $\rho(\cdot, s_p)$  for  $p = \frac{1}{7}$  or  $\frac{6}{7}$  or  $\frac{3}{7}$ , for different subsets of  $\Omega_m$ . So let  $\zeta_1$  and  $\zeta_2 \in \Omega_m(a_0)$  or  $\Omega_m(\overline{a_0})$  or  $\Omega_m(a_1, \pm)$ , and let  $\beta_i = \rho(\zeta_i, s_p)$  for  $i = 1$  and  $2$  and  $p = \frac{1}{7}, \frac{6}{7}$  or  $\frac{3}{7}$  in the respective cases. Then  $\beta_1$  and  $\beta_2$  are adjacent in  $\rho(\Omega_m, s_p)$  if and only if  $\zeta_1$  and  $\zeta_2$  are adjacent in  $\Omega_m$ . So each adjacent pair of paths in  $\Omega_m$  will lie in one of the following sets:

$$\gamma'_0 * (\Omega_m(a_0) \cup \{\omega_{0,a_0}, \omega_{\pm 1, a_0}, \omega_{0, \pm 1, a_0}\}),$$

and similarly for  $a_0$  replaced by  $\overline{a_0}$  and  $\gamma'_0$  replaced by the corresponding path  $\gamma_0$  in the lower half-plane, or

$$\Omega_m(a_1, -) \cup \{\omega_{-1}, \omega'_{-1}\},$$

$$\Omega_m(a_1, +) \cup \{\omega_1, \omega'_1, \omega_\infty\}.$$

We recall from 4.5 that  $\gamma'_0 * \omega_{i,a_0} = \omega'_i$  for  $i = 0, \pm 1$ . Also  $(\gamma'_0 * \omega_{0,1,a_0}, \omega'_1)$  is an adjacent pair matched with  $(\gamma_0 * \omega_{0,1,\overline{a_0}}, \omega_1)$  and similarly with  $1$  replaced by  $-1$ . So to find a complete set of matching pairs of adjacent pairs in  $\Omega_m$ , it suffices to achieve a complete set of matching pairs of adjacent pairs in each of the following sets:

$$(5.6.1) \quad \Omega_m(a_0), \Omega_m(\overline{a_0}), \Omega_m(a_1, -), \Omega_m(a_1, +).$$

We then define

$$(5.6.2) \quad \begin{aligned} R_m(a_0) &= \rho(\Omega_m(a_0), s_{1/7}), & R_m(\overline{a_0}) &= \rho(\Omega_m(\overline{a_0}), s_{6/7}), \\ R_m(a_1, -) &= \rho(\Omega_m(a_1, -), s_{3/7}), & R_m(a_1, +) &= \rho(\Omega_m(a_1, +), s_{3/7}). \end{aligned}$$

Adjacency is preserved by the mappings  $\rho(\cdot, s_q)$  for  $q = \frac{1}{7}, \frac{6}{7}$  or  $\frac{3}{7}$ . Matching pairs can also be viewed by considering the images under  $\rho(\cdot, \cdot)$ . Let  $(\zeta'_1, \zeta'_2)$  be an adjacent pair in  $\Omega_m$ , and we consider how the property of matching with the adjacent pair  $(\zeta_1, \zeta_2)$  transfers under  $\rho$ . Let  $\gamma \in \pi_1(V_{3,m}, s_q)$  and let  $\rho(\gamma, s_q) = \alpha$  and let

$\Phi_2(\gamma) = [\psi^{-1}]$ . Then, as we recalled in (4.3.1) to (4.3.3) (but note that we are now replacing  $\psi$  by  $\psi^{-1}$ ),

$$\rho(\gamma * \zeta'_i) = \alpha * \psi(\rho(\zeta'_i)).$$

Hence,  $\gamma * \zeta'_i = \zeta_i$  if and only if (5.6.3) and (5.6.4) hold for  $\beta_i = \rho(\zeta_i)$  and  $\beta'_i = \rho(\zeta'_i)$ :

$$(5.6.3) \quad \alpha * \psi(\beta'_i) = \beta_i \text{ rel } Y_m(s_q),$$

$$(5.6.4) \quad (s_q, Y_{m+1}(s_q)) \simeq_{\psi} (\sigma_{\alpha} \circ s_q, Y_{m+1}(s_q)).$$

In particular,  $\psi(\beta'_i)$  and  $\beta_i$  have the same endpoint, and the paths

$$\overline{\beta_1} * \beta_2, \quad \psi(\overline{\beta'_1} * \beta'_2)$$

are homotopic via a homotopy preserving  $Y_m(s_q)$ . For any  $\beta_i$  and  $\beta'_i \in \pi_1(\overline{\mathbb{C}} \setminus Z_m(s_q), Z_m(s_q), v_2)$  for which (5.6.3) and (5.6.4) hold, we have  $\alpha = \rho(\gamma)$  and  $[\psi] = \Phi_2(\gamma)$  for some  $\gamma \in \pi_1(B_{3,m}, s_p)$ . But if in addition  $\beta_i$  and  $\beta'_i \in D'(s_q)$  then we know that  $\gamma \in \pi_1(V_{3,m}, s_q)$ , because the stabiliser of  $D'$  in  $\pi_1(B_{3,m}, s_q)$  is  $\pi_1(V_{3,m}, s_q)$ .

So now we define a matching pair of adjacent pairs in one of the sets of (5.6.2) to be a pair of adjacent pairs  $((\beta_1, \beta_2), (\beta'_1, \beta'_2))$  such that each  $(\beta_i, \beta'_i)$  satisfies (5.6.3) for some  $\alpha \in \pi_1(\overline{\mathbb{C}} \setminus Z_m(s_q), v_2)$  and  $[\psi] \in \text{MG}(\overline{\mathbb{C}}, Y_{m+1}(s_q))$  satisfying (5.6.4). Then we can find a complete set of matching pairs of adjacent pairs in  $\Omega_m$ , if we can find a complete set of matching pairs of adjacent pairs in each of the sets of (5.6.1), and each of these sets lies in  $D'(s_q)$  for the appropriate value of  $q$ , for  $q = \frac{1}{7}$ ,  $\frac{6}{7}$ , or  $\frac{3}{7}$ .

## 5.7.

We are now ready to give a second, rather vague, statement of the Main Theorem.

**Main Theorem (vague version)** *A fundamental domain for  $V_{3,m}$  can be constructed using a set  $\Omega_m \subset \pi_1(V_{3,m}, P_{3,m}, a_1)$  with*

$$\Omega_m = \gamma'_0 * \Omega_m(a_0) \cup \gamma_0 * \Omega_m(\overline{a_0}) \cup \Omega_m(a_1, -) \cup \Omega_m(a_1, +),$$

$$R_m(a_0) = \rho(\Omega_m(a_0), s_{1/7}), \quad R_m(\overline{a_0}) = \rho(\Omega_m(\overline{a_0}), s_{6/7})$$

$$R_m(a_1, -) = \rho(\Omega_m(a_1, -), s_{3/7}), \quad R_m(a_1, +) = \rho(\Omega_m(a_1, +), s_{3/7}).$$

Here:

- $\gamma'_0$  and  $\gamma_0$  are the paths from  $h_{a_1}$  to  $h_{a_0}$   $h_{\overline{a_0}}$  of 4.5;
- the paths of  $\Omega_m(a)$  are in  $V_m(a)$  up to homotopy, apart from second endpoints in  $P_m(a)$ , and with first endpoints at  $h_a$ , for  $a = a_0$  and  $\overline{a_0}$ ;
- the paths of  $\Omega_m(a_1, +)$  are in  $V_m(a_1, +)$  up to homotopy, apart from second endpoints at  $P_m(a_1, +)$ , and with first endpoints at  $h_{a_1}$ , and similarly for  $\Omega_m(a_1, -)$ .

### 5.8. Checking vertex group elements

To know that the set  $\Omega_m$  of 5.7 gives a fundamental domain for  $V_{3,m}$ , by 5.4, we only need to know that the group vertex elements are simple parabolics. We now assume that  $\Omega_n$  is a sequence of path sets,  $0 \leq n \leq m$ , as in 5.5, with  $\Omega_{n-1} \subset \Omega_n$ . Then the vertex group elements of the fundamental domain associated to  $\Omega_{n-1}$  are projections under the forgetful homomorphism of the vertex group elements of the fundamental domain associated to  $\Omega_n$ , by 5.5. If the projection under the forgetful homomorphism of a parabolic element  $h$  is simple, then  $h$  is itself simple. So to show that all group vertex elements are simple parabolics, we only need to show this for all vertices of  $\Omega_n$  corresponding to points of  $P_{3,n} \setminus P_{3,n-1}$ , for each  $n \leq m$ . Now we give a criterion for this in terms of  $\rho(\Omega_n, s)$ .

So let  $\beta_i, \beta_{i,2}$  and  $\beta_{i,3} \in \rho(\Omega_n, s) \subset \pi_1(\overline{\mathbb{C}} \setminus Z_n(s), v_2, Z_n(s))$  end at points of  $Z_n(s) \setminus Z_{n-1}(s)$  for  $1 \leq i \leq r$  and suppose that each  $((\beta_i, \beta_{i,2}), (\beta_{i+1}, \beta_{i,3}))$  is the image of an adjacent pair of matching adjacent pairs, with  $\beta_{r+1} = \beta_1$ . Equivalently for each  $1 \leq i \leq r$ , there is  $\gamma_i \in \pi_1(V_{3,n}, s)$  such that the following holds for  $[\psi_i^{-1}] = \Phi_2(\gamma_i)$ :

$$(5.8.1) \quad \begin{aligned} (\sigma_{\beta_{i+1}} \circ s, Y_n(s)) &\simeq_{\psi_i} (\sigma_{\beta_i} \circ s, Y_n(s)), \\ (\sigma_{\beta_{i,3}} \circ s, Y_n(s)) &\simeq_{\psi_i} (\sigma_{\beta_{i,2}} \circ s, Y_n(s)). \end{aligned}$$

In particular,  $\beta_i$  and  $\psi_i(\beta_{i+1})$  share a common endpoint in  $Z_n(s) \setminus Z_{n-1}(s)$ . Write  $\psi_{j,i} = \psi_j \circ \dots \circ \psi_i$  for  $1 \leq j \leq i \leq r$  and  $\psi_{j,j-1} = \text{identity}$ . Then

$$(5.8.2) \quad \Phi_2(\gamma_j * \dots * \gamma_i) = [\psi_{j,i}^{-1}].$$

Let  $h_i$  be the element of the covering group of  $V_{3,n}$  corresponding to  $\gamma_i$ . Then  $\beta_i$  and  $\psi_{1,i}(\beta_i)$  share a common endpoint for  $1 \leq i < r$ ,  $\psi_{1,r}(\beta_{r+1}) = \psi_{1,r}(\beta_1) = \beta_1$ , and  $h_1 \dots h_r$  is a vertex group element for the fundamental domain corresponding to  $\Omega_n$  under the correspondence described in 4.2. We claim that the following is sufficient for  $h_1 \dots h_r$  to be a simple parabolic element, that is, for  $\gamma_1 * \dots * \gamma_r$  to be a simple path round a puncture of  $V_{3,n}$ .

*Simple parabolic criterion* The cyclic order of paths  $\psi_{1,i}(\beta_{i+1})$   $0 \leq i < r$  round the common endpoint in  $Z_n(s) \setminus Z_{n-1}(s)$  respects the order of the indices.

We see this as follows. Let  $\zeta_i$  be the unique loop which is isotopic in  $\overline{\mathbb{C}} \setminus Z_n(s)$  to an arbitrarily small perturbation of both  $\beta_i * \psi_i(\overline{\beta_{i+1}})$  and  $\beta_{i,2} * \psi_i(\overline{\beta_{i,3}})$ . Thus  $\zeta_i = \rho(\gamma_i, s)$  and in fact we can see directly from (5.8.1) that

$$(5.8.3) \quad \begin{aligned} s &\simeq_{\psi_i} \sigma_{\zeta_i} \circ s, \\ \zeta_k &= \rho(\gamma_k, s). \end{aligned}$$

Then for  $1 \leq j \leq i \leq r$ ,

$$s \simeq_{\psi_{j,i}} \sigma_{\zeta_{j,i}} \circ s,$$

where

$$\zeta_{j,i} = \zeta_j * \psi_{j,j}(\zeta_{j+1}) * \cdots * \psi_{j,i-1}(\zeta_i) = \rho(\gamma_j * \cdots * \gamma_i, s).$$

(See (4.3.3), (4.3.5), but this also follows from (5.8.2).) Now  $\zeta_{j,i}$  is an arbitrarily small perturbation of  $\beta_j * \psi_{j,i}(\overline{\beta_{i+1}})$ . So  $\zeta_{1,r}$  is homotopic to a simple loop once round a point of  $Z_n \setminus Z_{n-1}(s)$ . We claim that  $\gamma_1 * \cdots * \gamma_r$  must also be a simple loop. For we know that  $h_1 \cdots h_r$  is parabolic. So  $\gamma_1 * \cdots * \gamma_r = \delta^p$  for some  $p \geq 1$  and simple loop  $\delta$  round a point of  $V_{3,n} \setminus V_{3,n-1}$ . So  $\Phi_2(\delta)$  is isotopic to the identity via an isotopy preserving  $Z_n(s)$ , and by (4.3.5) we have

$$\zeta_{1,r} = \rho(\delta^p, s) = (\rho(\delta, s))^p.$$

Since  $\zeta_{1,r}$  is simple, we must have  $p = 1$ .

In our cases, the Simple parabolic criterion is satisfied rather easily. Let  $R$  one of the sets of (5.6.2). Then in all cases, for a cycle of paths  $\beta_i$  as above with endpoints in  $Z_n(s) \setminus Z_{n-1}(s)$ , we shall have  $r = 1$  or  $2$ . There is only one cyclic order on a set of one or two paths.

## CHAPTER 6

### EASY CASES OF THE MAIN THEOREM

#### 6.1. Restatement of the Main Theorem in the easy cases

We now give detail of the Main Theorem in the easy cases. We recall that for any  $q \in (0, 1) \cap \mathbb{Q}$  which is in the boundary of a gap  $G$  of  $L_{3/7}$ ,  $\beta_q$  is a path from  $v_2 = \infty$  to a point of  $\cup_m Z_m(s_{3/7})$ , which crosses  $S^1$  at  $e^{2\pi i q}$  into  $G$ , and ends at the point of  $\cup_m Z_m(s_{3/7})$  in  $G$ . We also use  $\beta_{1/3}$  for a path in  $\{z : |z| \geq 1\}$  from  $v_2$  to  $e^{2\pi i(1/3)}$ . This path is defined up to homotopy keeping the first endpoint and  $Z_m(s_{3/7})$  fixed, and the second endpoint on the loop  $\ell_{1/3} \cup \ell_{1/3}^{-1}$ , where  $\ell_{1/3}$  is the leaf of  $L_{3/7}$  with endpoints  $e^{\pm 2\pi i(1/3)}$

**Main Theorem (final version, easy cases)** *A fundamental domain for  $V_{3,m}$  can be constructed using a set  $\Omega_m \subset \pi_1(V_{3,m}, P_{3,m}, a_1)$  with*

$$\Omega_m = \gamma'_0 * \Omega_m(a_0) \cup \gamma_0 * \cup \Omega_m(\bar{a}_0) \cup \Omega_m(a_1, -) \cup \Omega_m(a_1, +),$$

$$R_m(a_0) = \rho(\Omega_m(a_0), s_{1/7}), \quad R_m(\bar{a}_0) = \rho(\Omega_m(\bar{a}_0), s_{6/7})$$

$$R_m(a_1, -) = \rho(\Omega_m(a_1, -), s_{3/7}), \quad R_m(a_1, +) = \rho(\Omega_m(a_1, +), s_{3/7}).$$

Here,  $\gamma'_0$  and  $\gamma_0$  are the paths from  $h_{a_1}$  to  $h_{a_0}$  and  $h_{\bar{a}_0}$  of 5.6. The paths of  $\Omega_m(a)$  are in  $V_m(a)$  up to homotopy, apart from second endpoints in  $P_m(a)$ , and with first endpoints at  $h_a$ , for  $a = a_0$  and  $\bar{a}_0$ . The paths of  $\Omega_m(a_1, +)$  are in  $V_m(a_1, +)$  up to homotopy, apart from second endpoints at  $P_m(a_1, +)$ , and with first endpoints at  $h_{a_1}$ , and similarly for  $\Omega_m(a_1, -)$ . The structures of  $\Omega_m(a_0)$  and  $\Omega_m(\bar{a}_0)$  and  $\Omega_m(a_1, -)$  are as follows.

1. Write  $s = s_{1/7}$ . Let  $T_m(s)$  be as in 5.3. Let  $T'_m(s)$  be the subset of  $T_m(s)$ , obtained by deleting all edges and vertices lying entirely in the smaller region of the disc bounded by the leaf with endpoints at  $e^{2\pi i(1/7)}$ ,  $e^{2\pi i(2/7)}$ , apart from the vertex at  $v_1$ . Then  $R_m(a_0)$  is the set of arcs in the complement of  $T_m(s_{1/7})$ , apart from the second endpoints, from  $v_2$  to the vertices of  $T'_m(s)$ , with one path of  $R_m(a_0)$  approaching each vertex between each pair of adjacent edges ending at that vertex. The matching pairs of adjacent pairs  $((\beta_1, \beta_2), (\beta'_1, \beta'_2))$  of  $R_m(a_0)$

are defined by the property that  $\overline{\beta_1} * \beta_2$  and  $\overline{\beta'_1} * \beta'_2$  bound a topological disc containing an edge of  $T'_m(s)$ , and  $\beta_1, \beta'_1$  have a common endpoint, as do  $\beta_2$  and  $\beta'_2$ . Suppose that  $\beta_i = \rho(\zeta_i)$  and  $\beta'_i = \rho(\zeta'_i)$ , and let  $\gamma \in \pi_1(V_{3,m}, s)$  be the element with

$$\gamma * \zeta_i = \zeta'_i, \quad i = 1, 2.$$

Let  $\alpha = \rho(\gamma) \in \pi_1(\overline{\mathbb{C}} \setminus Z_m(s), v_2)$  and  $\Phi_2(\gamma) = [\psi^{-1}] \in \text{MG}(\overline{\mathbb{C}}, Y_{m+1}(s))$ , that is, similarly to 5.8:

$$(6.1.1) \quad (s, Y_{m+1}(s)) \simeq_\psi (\sigma_\alpha \circ s, Y_{m+1}(s)),$$

$$(6.1.2) \quad \alpha * \psi(\beta'_i) = \beta_i \text{ in } \pi_1(\overline{\mathbb{C}} \setminus Z_m(s), Z_m(s), v_2).$$

Then  $\psi$  fixes the common endpoint of  $\beta_i$  and  $\beta'_i$  for  $i = 1, 2$ , and

$$(6.1.3) \quad \overline{\beta'_1} * \beta'_2 = \psi(\overline{\beta_1} * \beta_2) \text{ rel } Z_{m+1}(s).$$

Exactly similar statements hold for  $R_m(\overline{a_0})$ , with  $\frac{1}{7}, \frac{2}{7}$  replaced by  $\frac{6}{7}, \frac{5}{7}$ .

2. Exactly similar statements hold for  $R_m(a_1, -)$ . Here  $T'_m(s_{3/7})$  is obtained from  $T_m(s_{3/7})$  by deleting all edges and vertices lying entirely in the larger region of the disc bounded by the leaf with endpoints at  $e^{2\pi i(1/7)}, e^{2\pi i(6/7)}$ , apart from the vertex at  $s_{3/7}(v_1)$ .

## 6.2. Derivation of the first version of the Main Theorem from the second

One claim of 6.1 is that two paths in  $V_{3,m}(a_0)$  or  $V_{3,m}(\overline{a_0})$  or  $V_{3,m}(a_1, -)$  end at the same point of  $P_{3,m}(a_0)$  or  $P_{3,m}(\overline{a_0})$  or  $P_{3,m}(a_1, -)$  if and only if the images under  $\rho_2(\cdot, s_p)$ , for  $p = \frac{1}{7}$  or  $\frac{6}{7}$  or  $\frac{3}{7}$ , have the same endpoint in  $Z_m(s_p)$ . Another claim is that, for any path  $\omega$  in  $V_{3,m}$  with such an endpoint,  $\rho_2(\omega) = \beta$  for  $\beta$  with a single  $S^1$ -crossing and thus, as we have seen in 2.8, if  $\omega$  ends at  $a$ ,  $h_a$  is Thurston equivalent to the capture  $\sigma_\beta \circ s_p$ . So all maps  $h_a$  with

$$a \in P_{3,m}(a_0) \cup P_{3,m}(\overline{a_0}) \cup P_{3,m}(a_1, -)$$

are Thurston equivalent to captures of the types claimed in 2.10, and the paths in  $\Omega_m(a_0)$ ,  $\Omega_m(\overline{a_0})$  and  $\Omega_m(a_1, -)$  are completely determined by their images under  $\rho_2$  in  $R_m(a_0)$ ,  $R_m(\overline{a_0})$  and  $R_m(a_1, -)$ . Note that by Tan Lei's result, summarized in 2.6, all these captures are indeed Thurston equivalent to rational maps, so that the sets  $R_m(a_0)$ ,  $R_m(\overline{a_0})$  and  $R_m(a_1, -)$  do lift to  $D'(s_p)$  for  $p = \frac{1}{7}, \frac{6}{7}, \frac{3}{7}$ . Furthermore, the restatement of 6.1 implies that we have a fundamental domain for  $V_{3,m}$  such that the associated tree intersects  $V_{3,m}(a_0)$  in a tree which is naturally homeomorphic to  $T'_m(s_{1/7})$ , and similarly for  $V_{3,m}(\overline{a_0})$  and  $V_{3,m}(a_1, -)$ . So we have a one-to-one correspondence between  $P_m(a_0)$  and  $T'_m(a_0) \cap Z_m(s_{1/7})$ , and similarly for  $P_m(\overline{a_0})$  and  $T'_m(\overline{a_0}) \cap Z_m(s_{6/7})$ , and for  $P_m(a_1, -)$  and  $T'_m(a_1) \cap Z_m(s_{3/7})$ . So captures with the

same endpoint in any of these regions are Thurston equivalent — which we already saw directly in 2.8 — and there are no further Thurston equivalences. The map  $a \mapsto \omega(a)$  in these regions is not completely canonically defined, but paths with the same endpoint in  $P_{3,m}(a_0) \cup P_{3,m}(\overline{a_0}) \cup P_{3,m}(a_1, -)$  are mapped under  $\rho(\cdot, s_p)$  to paths with the same endpoint, and we can choose  $\omega(a)$  to be any path in  $\Omega$  with endpoint at  $a$ , for all such  $a$ .

### 6.3. Proofs in the easy cases

The completion of the proofs of Theorem 6.1 in the case of  $R_m(a_0)$ ,  $R_m(\overline{a_0})$  and  $R_m(a_1, -)$  are all very similar, so we concentrate on the case of  $R_m(a_0)$ . Write  $s = s_{1/7}$ . We only need to show that pairs of pairs of adjacent arcs  $((\beta_1, \beta_2), (\beta'_1, \beta'_2))$  of  $R_m(a_0)$  which bound a common edge  $e$  of  $T'_m(s)$  are indeed matched as claimed, that is, there is  $\alpha \in \pi_1(\overline{\mathbb{C}} \setminus Z_m(s), v_2)$  and  $[\psi] \in \text{MG}(\overline{\mathbb{C}}, Y_m(s))$  such that

$$(6.3.1) \quad \begin{aligned} \alpha * \psi(\beta'_i) &\simeq \beta_i \text{ rel } Y_m(s), \\ (s_{1/7}, Y_m(s)) &\simeq_\psi (\sigma_\alpha \circ s, Y_m(s)). \end{aligned}$$

This will imply that

$$(6.3.2) \quad \sigma_{\beta'_i} \circ s \simeq_\psi \sigma_{\beta_i} \circ s.$$

We also need to show that  $\psi$  fixes the second (common) endpoint of  $\beta_i$  and  $\beta'_i$ . The Simple parabolic criterion of 5.8 then follows from the fact that every vertex of  $T'_m(s)$  in  $Z_m(s) \setminus Z_{m-1}(s)$  is a meeting of at most two edges of  $T'_m(s)$ . In the first two cases, such vertices are always extreme, and therefore attached to only one edge.

Assume without loss of generality that  $\beta_1 * \overline{\beta'_1}$  bounds an open disc  $D(\beta_1)$  containing  $\beta_2 * \overline{\beta'_2}$ , and let  $r$  be the greatest integer such that  $D(\beta_1)$  does not intersect  $Z_{r-1}(s)$ . Then  $r \geq 1$ . In the case of  $R_m(a_0)$ ,  $r$  is greater than the preperiod of the endpoint of  $\beta_1$ . In the case of  $R_m(a_1, -)$ , this may not be true, but this does not matter. Let  $\alpha_r$  be the closed loop which is an arbitrarily small perturbation of  $\partial D(\beta_1)$ , and in  $D(\beta_1)$ , apart from having endpoint at  $v_2$ . Then  $\alpha_r$  bounds a disc  $D(\alpha_r)$ , whose intersection with  $T_m(s)$  is a subtree of  $T_m(s)$ , with basepoint on  $e$ . Then we define

$$\psi_r = \sigma_{\alpha_r},$$

and define  $\alpha_p, \psi_p$  inductively for  $p \geq r$  by

$$(6.3.3) \quad \psi_p \circ s = \sigma_{\alpha_p} \circ s \circ \psi_{p+1},$$

and  $\alpha_{p+1}$  is an arbitrarily small perturbation of  $\beta_1 * \psi_p(\overline{\beta'_1})$ . Write

$$(6.3.4) \quad \psi_{p+1} = \xi_p \circ \psi_p.$$

Then

$$\xi_p \circ \psi_p \circ s = \sigma_{\alpha_{p+1}} \circ s \circ \xi_{p+1} \circ \psi_{p+1},$$

giving

$$\xi_p \circ \sigma_{\alpha_p} \circ s \circ \psi_{p+1} = \sigma_{\alpha_{p+1}} \circ s \circ \xi_{p+1} \circ \psi_{p+1},$$

and since  $\xi_p(\alpha_p)$  is a perturbation of  $\xi_p(\beta_1) * \psi_{p+1}(\overline{\beta'_1})$ , we obtain

$$(6.3.5) \quad \xi_p \circ \sigma_{\beta_1} \circ s = \sigma_{\beta_1} \circ s \circ \xi_{p+1}.$$

Then the support of  $\xi_p$  is contained in  $(\sigma_{\beta_1} \circ s)^{r-p-1}(D(\zeta))$ , and does not intersect the edge  $e$  for  $m \geq p > r$ , nor the adjacent vertices. So  $\psi_p$  fixes the common endpoint of  $\beta_i$  and  $\beta'_i$  for both  $i = 1$  and  $2$  and for  $p \geq r$ . The support is allowed to intersect  $\beta'_1$  and  $\beta'_2$  elsewhere, and almost certainly will. Then for  $p = m$ ,  $\alpha_m = \alpha$ ,  $\psi_m = \psi$ , we have (6.3.2) for  $i = 1, 2$ . So we have all the required properties.  $\square$



## CHAPTER 7

### THE HARD CASE: FINAL STATEMENT AND EXAMPLES

#### 7.1.

Throughout this section, we write

$$\begin{aligned} s &= s_{3/7}, \\ Y_n &= Y_n(s) = Y_n(s_{3/7}), \\ Z_n &= Z_n(s) = Z_n(s_{3/7}). \end{aligned}$$

Also,  $U^p$  is the subset of the unit disc defined in 2.10, and, as in 3.3,

$$q_p = \frac{1}{3} - 2^{-2p} \frac{1}{21}.$$

#### 7.2. Some conjugacy tracks

We recall the notation  $\psi_{m,q}$  of 3.3 for the conjugacy, up to  $Y_m$ -preserving isotopy, between  $\sigma_q \circ s$  and  $\sigma_{1-q} \circ s$ , remembering that  $\psi_{m+1,q} = \xi_{m,q} \circ \psi_{m,q}$ . In 3.3, we defined  $\psi_{m,q}$  for  $q = q_k$  and  $0 \leq m \leq 2k + 2$ . We can extend the definition to all  $m \geq 0$  by defining  $\alpha_{m,q_k}$  and  $\psi_{m+1,q_k}$  inductively for  $m \geq 2k+2$  as follows. We define  $\alpha_{m,q_k}$  to be an arbitrarily small perturbation of  $\beta_{q_k} * \psi_{m,q_k}(\overline{\beta_{1-q_k}})$  which bounds a disc containing  $v_1$  and disjoint from the endpoint of  $\beta_{q_k}$ . Note that  $\psi_{2k+2,q_k}$  is the identity on  $\beta_{1-q_k}$ , and hence  $\alpha_{2k+2,q_k}$  is an arbitrarily small perturbation of  $\beta_{q_k} * \overline{\beta_{1-q_k}}$ . Writing  $q = q_k$ , we then define  $\psi_{m+1,q}$  for  $m \geq 2k + 2$  by

$$(7.2.1) \quad \sigma_{\alpha_{m,q}} \circ s \circ \psi_{m+1,q} = \psi_{m,q} \circ s,$$

and

$$(7.2.2) \quad [\psi_{m+1,q}] = [\psi_{m,q}] \text{ in } \text{MG}(\overline{\mathbb{C}}, Y_m(s)).$$

As in 3.3, we then define  $\xi_{m,q}$ , for all  $m$ , and for  $q = q_k$ , by

$$\psi_{m+1,q} = \xi_{m,q} \circ \psi_{m,q}.$$

As in 6.3 we then obtain that, for  $m \geq 2k + 1$ ,

$$(7.2.3) \quad \sigma_{\beta_q} \circ s \circ \xi_{m+1,q} = \xi_{m,q} \circ \sigma_{\beta_q} \circ s.$$

The support of  $\xi_{m,q}$  is a union of annuli

$$(7.2.4) \quad A_{m,q} = (\sigma_{\beta_q} \circ s)^{2k+1-m}(A_{2k+1,q})$$

for  $m \geq 2k + 1$ , and

$$(7.2.5) \quad C_{m,q} = (\sigma_{\beta_q} \circ s)^{-m}(C_{0,q})$$

for  $m \geq 0$ . In the case  $q = \frac{2}{7}$  we still have this, but we also have

$$A_{m,2/7} = (\sigma_{2/7} \circ s)^{1-m}(A_{1,2/7}),$$

and

$$C_{m,2/7} = (\sigma_{2/7} \circ s)^{1-m}(C_{1,2/7})$$

for  $m \geq 1$ , remembering that  $s_{1/7} = \sigma_{\zeta_{2/7}}^{-1} \circ \sigma_{\beta_{2/7}} \circ s$ , and that  $\zeta_{2/7} \subset s^{-1}(\beta_{2/7})$ , which is disjoint from  $A_{m,2/7}$  for all  $m \geq 1$ .

The definition of  $\xi_{m,q}$  from the sets  $A_{m,q}$  and  $C_{m,q}$  is given, up to isotopy preserving  $Y_n$  for any  $n$ , in terms of *beads* on the sets  $A_{m,q}$  and  $C_{m,q}$ . A bead on  $A_{m,q}$  is a component of  $A_{m,q} \cap \{z : |z| \leq 1\}$ . The definition of a bead on  $C_{m,q}$  is slightly different, and in addition, there are two different types of bead on  $C_{m,q}$  for  $q = q_k$  and  $k \geq 1$ , but only one type of bead for  $k = 0$ , that is, for  $q_0 = \frac{2}{7}$ . The easiest way to define them seems to be to define the beads on  $C_{0,q}$ , which we shall do shortly. The beads on  $C_{m,q}$  are then the preimages under  $s^m$  (and also under  $(\sigma_{\beta_q} \circ s)^m$ ) of the beads on  $C_{0,q}$ . The homeomorphism  $\xi_{m,q}$  sends each bead on  $A_{m,q}$  to the next bead on the same annulus component of  $A_{m,q}$ , in the anticlockwise direction, and sends each bead on  $C_{m,q}$  to the next same type bead on the same annulus component, in the clockwise direction. We now describe the sets in some detail.

First, we draw  $A_{m,2/7}$  for  $1 \leq m \leq 5$ . We draw  $C_{0,2/7}$  on the same diagram as  $A_{1,2/7}$ . The intersection of  $C_{0,2/7}$  with  $\cup_n Y_n$  is contained in the (non-closed) disc which is the smaller component of  $\{z : |z| \leq 1\} \setminus \ell$ , where  $\ell$  is the leaf of  $L_{3/7}$  with endpoints at  $e^{\pm 2\pi i(1/7)}$ . We can choose a smaller disc within this disc, which is closed, is contained in  $C_{0,2/7}$ , contains all the points of  $\cup_n Y_n$  within  $C_{0,2/7}$ , and does not intersect  $\ell$ , although it does contain the endpoints  $e^{\pm 2\pi i(1/7)}$ . This is the unique bead on  $C_{0,2/7}$ . In the case  $m = 5$ , we only draw two of the components of  $A_{5,2/7}$ , and these on separate diagrams. We also draw one component of  $A_{6,2/7}$ .

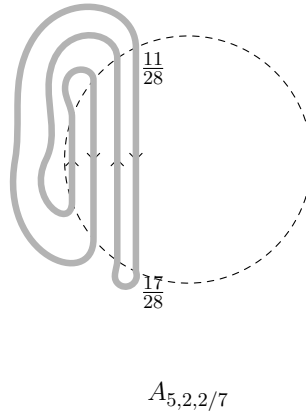
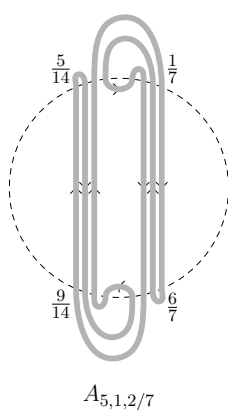
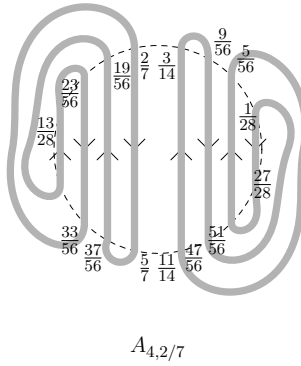
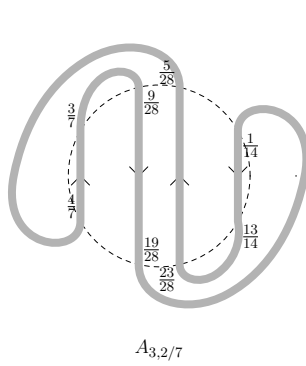
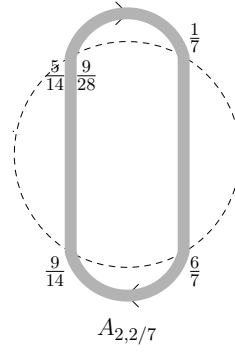
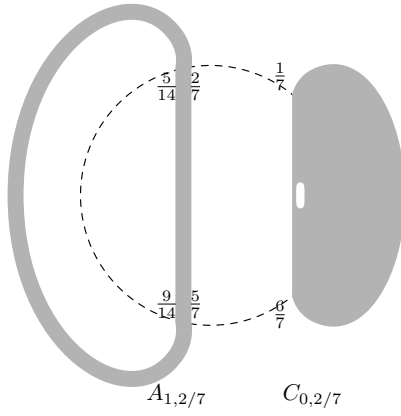

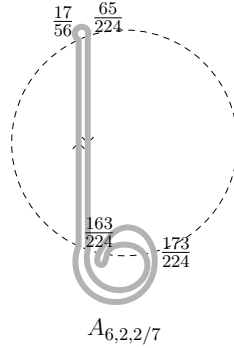

We see that  $A_{m,2/7}$  has just one component for  $m = 2$  or  $3$ , and two for  $m = 4$ . We call the lefthand component  $A_{4,1,2/7}$ , and the righthand component  $A_{4,2,2/7}$ . Then the map  $\sigma_{2/7} \circ s : A_{5,1,2/7} \rightarrow A_{4,1,2/7}$  is degree two and  $A_{5,1,2/7}$  is homotopic to  $A_{2,2/7}$  in  $\mathbb{C} \setminus Z_0(s)$ . We let  $A_{5,2,2/7}$  and  $A_{5,3,4/7}$  be the two components of the preimage of  $A_{4,2,2/7}$ , with  $A_{5,2,2/7}$  to the left as drawn. On most of the diagrams, we have labelled intersection points of only one boundary of the annulus with the unit circle  $S^1$ , using the convention of writing  $x$  for  $e^{2\pi ix}$ .

For  $A_{5,1,2/7}$ ,  $A_{5,2,2/7}$  and  $A_{6,2,2/7}$ , there is not space to include all the labels, even on one side of the annulus. For  $A_{5,1,2/7}$ , starting from the outer edge of the top leftmost intersection point with  $S^1$ , the points, proceeding in a clockwise direction round this edge, are:  $\frac{5}{14}$  (as labelled), and then:

$$\frac{37}{112}, \frac{75}{112}, \frac{43}{56}, \frac{41}{56}, \frac{79}{112}, \frac{33}{112}, \frac{1}{7}, \frac{6}{7}, \frac{93}{112}, \frac{19}{112}, \frac{15}{56}, \frac{13}{56}, \frac{23}{112}, \frac{89}{112}, \frac{9}{14}.$$

The width of this annulus is  $\frac{1}{224}$ . For  $A_{5,2,2/7}$ , starting at the top rightmost intersection point with  $S^1$  and proceeding in a clockwise direction the intersection points are  $\frac{11}{28}$  (as labelled) and then:

$$\frac{17}{28}, \frac{65}{112}, \frac{47}{112}, \frac{29}{56}, \frac{27}{56}, \frac{51}{112}, \frac{61}{112}.$$

The width of this annulus is also  $\frac{1}{224}$ . For  $A_{6,2,2/7}$ , starting at the top leftmost intersection with  $S^1$  and proceeding in a clockwise direction on this edge, the points are  $\frac{17}{56}$  (as labelled) and then:

$$\frac{65}{224}, \frac{159}{224}, \frac{85}{112}, \frac{83}{112}, \frac{163}{224}, \frac{173}{224}, \frac{39}{56}.$$

The width of this annulus is  $\frac{1}{448}$ .

The beads on  $A_{m,2/7}$  can be described by their words: each bead is  $D(w)$  for a word  $w$ , where  $D(w)$ , as in 2.9, is the set of points (topologically a closed disc) labelled by  $w$ . For  $A_{1,2/7}$  we have just one word:

$$L_3.$$

The homeomorphism  $\xi_{1,2/7}$  maps the corresponding bead to itself, rotating the annulus  $A_{1,2/7}$  in an anticlockwise direction. For  $A_{2,2/7}$  we have:

$$L_3^2 \rightarrow (\text{top})R_3L_3 \rightarrow (\text{bot})L_3^2.$$

Here, and subsequently, the arrows denote the direction of movement of beads in  $A_{m,2/7}$  under  $\xi_{m,2/7}$ . For  $A_{3,2/7}$ , we have:

$$L_2R_3L_3 \rightarrow L_3^3 \rightarrow R_2R_3L_3 \rightarrow R_3L_3^2 \rightarrow L_2R_3L_3.$$

For  $A_{4,2/7}$  we have two cycles, in  $A_{4,1,2/7}$  and  $A_{4,2,2/7}$ :

$$L_1R_2R_3L_3 \rightarrow L_2R_3L_3^2 \rightarrow L_3L_2R_3L_3 \rightarrow L_3^4 \rightarrow L_1R_2R_3L_3,$$

$$R_1R_2R_3L_3 \rightarrow R_2R_3L_3^2 \rightarrow R_3L_2R_3L_3 \rightarrow R_3L_3^3 \rightarrow R_1R_2R_3L_3.$$

For  $A_{5,2/7}$  there are three cycles, in  $A_{5,i,2/7}$  for  $i = 1, 2$  and  $3$ , with 8 beads in  $A_{5,1,2/7}$ , as was shown. The cycle for  $A_{5,1,2/7}$  is:

$$(\text{bot})BCL_1R_2R_3L_3 \rightarrow (\text{bot})L_3L_2R_3L_3^2 \rightarrow (\text{top})R_3L_3L_2R_3L_3 \rightarrow (\text{bot})R_3L_3^4 \rightarrow$$

$$(\text{top})UCL_1R_2R_3L_3 \rightarrow (\text{top})R_3L_2R_3L_3^2 \rightarrow (\text{bot})L_3^2L_2R_3L_3 \rightarrow (\text{top})L_3^5 \rightarrow$$

$$(\text{bot})BCL_1R_2R_3L_3.$$

Inductively, for  $m \geq 6$ , we define a component  $A_{m+1,1,2/7}$  to be a component of  $A_{m+1,2/7}$  which is a preimage under  $\sigma_{2/7} \circ s$  of  $A_{m,1,2/7}$ , and homotopic to  $A_{m-2,1,2/7}$  in  $\mathbb{C} \setminus Z_{m-4}(s)$ . The connection  $L_3^2 \rightarrow (\text{top})R_3L_3$  in  $A_{2,2/7}$  is essentially periodic of period 3. It reappears in  $A_{5,1,2/7}$  with:

$$L_3L_2R_3L_3^2 \rightarrow (\text{top})R_3L_3L_2R_3L_3,$$

and similarly in  $A_{3n+2,1,2/7}$  for all  $n \geq 1$ . All other preimages remain close under backward iterates. Even if the first letter is not the same, as in  $L_3w_1 \rightarrow BCw_2$ , there is only way letters can remain different under taking preimages, for this one, for example, by taking  $(L_2R_3L_3)^m w_1 \rightarrow (L_1R_2BC)^m w_2$ . We call  $A_{m,1,2/7}$  the *periodic component* of  $A_{m,2/7}$

Now we draw some of the sets  $C_{m,2/7}$ .

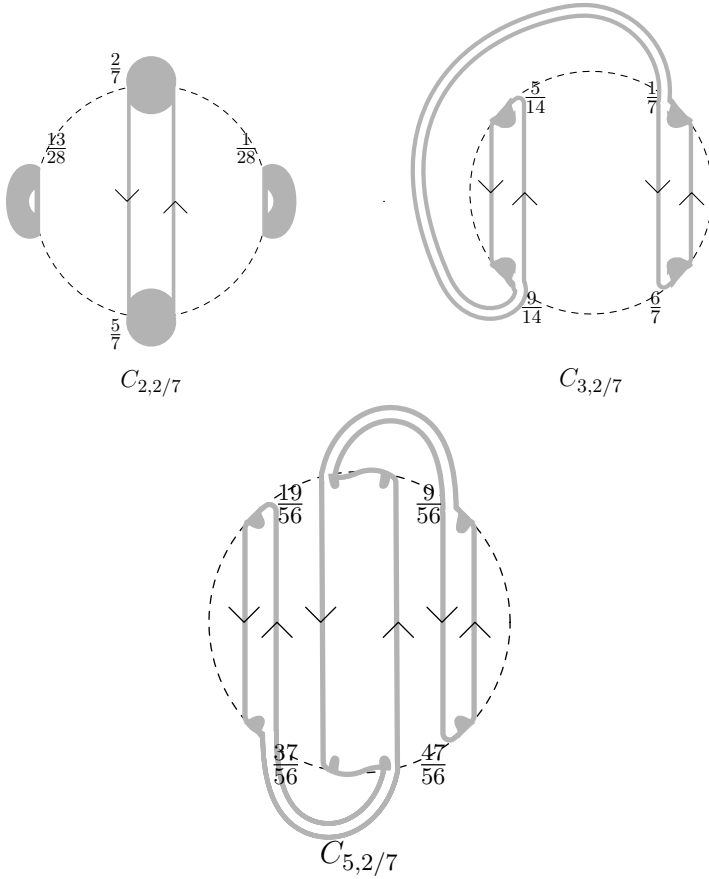

Now, similarly to what we did for the sequence  $A_{m,2/7}$ , we consider the words for the beads on  $C_{m,2/7}$  for  $m \geq 2$ . For all  $m \geq 1$ , the set  $C_{m,2/7}$  has more than one component, but one bounds a disc containing a component of  $Z_0(s)$ . We call this the *periodic* component. The beads are again labelled by words. In fact, each bead is the union of the closure of the interior of  $D(w)$  for a word  $w$ , for  $D(w)$  as in 2.9. The word path for the periodic component of  $C_{2,2/7}$  is

$$UC \rightarrow BC \rightarrow UC.$$

This has one preimage in  $C_{3,2/7}$ , represented by:

$$R_2BC \rightarrow R_2UC \rightarrow L_2BC \rightarrow L_2UC \rightarrow R_2BC.$$

This has two preimages in  $C_{4,2/7}$ :

$$\begin{aligned} &(\text{top})L_1R_2BC \rightarrow (\text{bot})L_1R_2UC \rightarrow (\text{top})L_3L_2BC \rightarrow (\text{bot})L_3L_2UC \rightarrow \\ &(\text{top})L_1R_2BC, \end{aligned}$$

$$(\text{bot})R_1R_2BC \rightarrow (\text{top})R_1R_2UC \rightarrow (\text{bot})R_3L_2BC \rightarrow (\text{top})R_3L_2UC \rightarrow \\ (\text{bot})R_1R_2BC.$$

The first of these is the periodic one, and its preimage in  $C_{5,2/7}$  is represented by:

$$BCL_1R_2BC \rightarrow BCL_1R_2UC \rightarrow (\text{top})L_3^2L_2BC \rightarrow (\text{bot})L_3^2L_2UC \rightarrow \\ UCL_1R_2BC \rightarrow UCL_1R_2UC \rightarrow (\text{bot})R_3L_3L_2BC \rightarrow (\text{top})R_3L_3L_2UC \rightarrow \\ BCL_1R_2BC.$$

As with the  $A_{m,2/7}$  sequence, there is only one segment of track which is periodic, again of period 3. This is the piece represented by

$$(\text{top})R_3L_3L_2UC \rightarrow BCL_1R_2BC,$$

which has third preimage

$$BCL_1R_2R_3L_3L_2UC \rightarrow (\text{top})L_3^2L_2BCL_1R_2BC.$$

Now we make some remarks about the sets  $A_{m,q_k}$  and  $C_{m,q_k}$  for  $k \geq 1$ . Write  $\sigma_{q_k}$  for  $\sigma_\beta$ , where  $\beta = \beta_{q_k}$ . The general shape of the sets  $A_{m,q_k}$ , for  $m \leq 4$ , is the same as for  $A_{m,2/7}$ , but the beads are thinner. So we have two components  $A_{4,1,q_k}$  and  $A_{4,2,q_k}$  of  $A_{4,q_k}$ , with  $A_{4,1,q_k}$  on the left and  $A_{4,2,q_k}$  on the right. The annulus  $A_{4,2,q_k}$  is homotopically trivial relative to the critical forward orbit of  $\sigma_{q_k} \circ s$ , and consequently the preimages under  $(\sigma_{q_k} \circ s)^{m-4}$  of  $A_{4,2,q_k}$  in  $A_{m,q_k}$  are homotopic to corresponding components of  $A_{m,2/7}$  in  $Z_{m-3}(s)$ . But the preimage under  $\sigma_{q_k} \circ s$  in  $A_{5,q_k}$  of  $A_{4,1,q_k}$  has two components for  $k \geq 1$ , and, therefore, subsequent preimages are different. Inductively, for  $m \geq 5$ , we define a component  $A_{m+1,1,q_k}$  of  $A_{m,q_k}$  which is a component of  $(\sigma_{q_k} \circ s)^{-1}(A_{m,1,q_k})$  and homotopically nontrivial in  $\overline{C} \setminus Z_0(s)$ . These properties determine  $A_{m+1,1,q_k}$  uniquely. Then  $A_{m+1,1,q_k}$  is a homeomorphic preimage of  $A_{m,q_k}$  for  $5 \leq m < 2k + 4$ , and a degree two preimage for  $m = 2k + 4$ . Moreover,  $A_{2k+5,1,q_k}$  is homotopic to  $A_{2,q_k}$  relative to the critical forward orbit of  $\sigma_{q_k} \circ s$ , and  $A_{m+2k+3,1,q_k}$  and  $A_{m,1,q_k}$  are similarly homotopic, for all  $m \geq 3$ , defining  $A_{3,q_k} = A_{3,1,q_k}$ . We call  $A_{m,1,q_k}$  the *periodic component* of  $A_{m,q_k}$ , just as we did in the case  $k = 0$ .

For  $C_{0,q_k}$  for  $k \geq 1$ , the annulus has a rectangle next to the leaf with endpoints  $e^{\pm 2\pi i(1/7)}$ . The other vertical side of the rectangle is the leaf with endpoints  $e^{\pm 2\pi i(q_k/2)}$ . This gives the second type of bead on  $C_{0,q_k}$ , referred to above. The preimage in  $C_{3,q_k}$  of the periodic component of  $C_{2,q_k}$  has two components for  $k \geq 1$  and so again, of course, subsequent preimages are different. There is a component of  $C_{2k+3,q_k}$  which is in the backward orbit of the periodic component of  $C_{2,q_k}$  and which is a degree two preimage of a component of  $C_{2k+2,q_k}$ . This is a natural analogue of the periodic component of  $C_{3,2/7}$ .

### 7.3. Another sequence of homeomorphisms

Let  $\beta_{q_p}$ ,  $\alpha_{m,q_p}$  and  $\psi_{m,q_p}$  be as in 3.3 and 7.2. We are now going to define new sequences  $\alpha'_{m,q_p}$  and  $\psi'_{m,q_p}$ , for  $p \geq 0$  and  $m \geq 0$ . For  $m = 0$ ,

$$\alpha'_{0,q_p} = \alpha_{2/7}, \quad \psi'_{0,q_p} = \psi_{0,2/7}.$$

For  $m \leq 2p + 2$ ,

$$\psi'_{m,q_{p+1}} = \psi'_{m,q_p},$$

and  $\beta'_{q_p}$  is defined by:

$$\alpha_{2p,q_p} * \psi'_{2p,q_p}(\beta'_{q_p}) = \beta_{q_p}.$$

and, for  $m \leq 2p + 1$ :

$$\alpha'_{m,q_{p+1}} = \alpha'_{m,q_p}.$$

But  $\alpha_{2p+2,q_{p+1}}$  is such that

$$\alpha'_{2p+2,q_{p+1}} * \overline{\alpha'_{2p+2,q_p}} = \alpha_{q_{p+1}} * \overline{\alpha_{q_p}}.$$

Then inductively for  $m \geq 2p$ , we define  $\psi'_{m+1,q_p}$  in terms of  $\psi'_{m,q_p}$ , for  $q = q_p$ , by:

$$(7.3.1) \quad \sigma_{\alpha_{m,q}} \circ s \circ \psi'_{m+1,q} = \psi'_{m,q} \circ s,$$

$$(7.3.2) \quad \psi'_{m+1,q} = \psi'_{m,q} \text{ rel } Y_m,$$

and for  $m \geq 2p$ , we also define  $\alpha'_{m+1,q_p}$  in terms of  $\beta'_{q_p}$  and  $\psi'_{m+1,q_p}$  by:  $\alpha'_{m+1,q_p}$  is an arbitrarily small perturbation of

$$\beta_{q_p} * \psi'_{m+1,q_p}(\overline{\beta'_{q_p}}).$$

Finally, we define  $\xi'_{m,q_p}$  by

$$\psi'_{m+1,q_p} = \xi'_{m,q_p} \circ \psi'_{m,q_p}.$$

As an example which we shall consider later, let  $p = 1$ . Then:

$$\psi'_{1,9/28} = \psi_{1,2/7}, \quad \xi'_{1,9/28} = \xi_{1,2/7},$$

$$\psi'_{2,9/28} = \psi_{2,2/7} = \xi_{1,2/7} \circ \psi_{1,2/7}.$$

Recall from 3.3 that  $\psi_{1,2/7}$  is a composition of anticlockwise Dehn twists round the boundaries of two discs, which we call  $D_{2/7}$ , and  $D_{-,2/7}$ . Meanwhile,  $\xi_{1,2/7}$  is a composition of anticlockwise Dehn twists round the boundaries of the two disc components of  $s^{-1}(D_{-,2/7})$  and a clockwise twist in the annulus  $A_{1,2/7}$ , that is, a clockwise Dehn twist round the outer boundary composed with an anticlockwise Dehn twist round the inner boundary. Then we see that  $\beta'_{9/28} = \beta_{19/28}$ , and

$$\psi'_{2,9/28} = \psi_{2,9/28} \text{ rel } Y_3.$$

In fact

$$\psi'_{2,9/28} = \xi''_{2,9/28} \circ \psi_{2,9/28},$$



where  $\xi''_{2,9/28}$  is a composition of clockwise twists in annuli — in each annulus, the composition of clockwise twist round the outer boundary composed with with anti-clockwise twist round the inner boundary — where each annulus is trivial in  $Y_3$ . In fact there are four annuli involved. One annulus is the subannulus of  $A_{1,2/7}$  bounded by the component of  $\partial A_{1,2/7}$  crossing  $S^1$  at  $e^{\pm 2\pi i(5/14)}$  and by an interior loop of  $A_{1,2/7}$  whose intersection with the unit disc is the leaf between  $e^{\pm 2\pi i(9/28)}$ . The other annuli are the one which intersects the unit disc only between  $e^{\pm 2\pi i(9/56)}$  and  $e^{\pm 2\pi i(1/7)}$ , and which bounds a finite disc, and the two preimages of this one under  $s$ . It follows that

$$\psi'_{3,9/28} = \psi_{3,9/28} \text{ rel } Y_4,$$

and indeed for all  $m \geq 2$ ,

$$\psi'_{m,9/28} = \psi_{m,9/28} \text{ rel } Y_{m+1}.$$

Moreover if we write

$$\psi'_{m,9/28} = \xi''_{m,9/28} \circ \psi_{m,9/28}$$

then the support of  $\xi''_{2,9/28}$  is disjoint from  $\overline{\beta_{19/28}} * \beta_{5/7}$  and the support of  $\xi''_{4,9/28}$  is disjoint from  $\overline{\beta_{75/112}} * \beta_{19/28}$ . Extending this gives the following lemma.

**Lemma**

$$(7.3.3) \quad \alpha'_{m,q_p} = \alpha_{m,q_p} = \alpha_{q_p} = \text{in } \pi_1(\overline{\mathbb{C}} \setminus Z_{m+1}, v_2) \text{ for } m \geq 2p$$

$$(7.3.4) \quad [\psi'_{m,q_p}] = [\psi_{m,q_p}] \text{ in } \text{MG}(\overline{\mathbb{C}}, Y_{m+1}) \text{ for } m \geq 2p,$$

$$(7.3.5) \quad \text{supp}(\psi'_{2p+2,q_p}) \cap (\overline{\beta_{1-q_p}} * \beta_{1-q_{p+1}} \cup s^{-1}(\overline{\beta_{1-q_{p-1}}} * \beta_{1-q_p})) = \emptyset.$$

$$(7.3.6) \quad \beta'_{q_p} = \beta_{1-q_p} \text{ pointwise.}$$

*Proof.* – The proof is by induction. These statements are trivially true for  $p = 0$ . Now suppose that they are true for  $p$  and we prove them with  $p + 1$  replacing  $p$ . First we prove (7.3.6) for  $p + 1$ . Since  $\psi'_{2p+2,q_{p+1}} = \psi'_{2p+2,q_p}$  by definition, we have, by the definition of  $\beta'_{q_{p+1}}$  and  $\alpha'_{2p+2,q_{p+1}}$  and  $\alpha'_{2p+2,q_p}$ ,

$$\begin{aligned} \alpha'_{2p+2,q_{p+1}} * \overline{\alpha'_{2p+2,q_p}} &= \alpha_{2p+2,q_{p+1}} * \overline{\alpha_{2p+2,q_p}}. \\ \alpha'_{2p+2,q_{p+1}} &= \text{perturbation of } \beta_{q_{p+1}} * \psi'_{2p+2,q_p}(\beta'_{q_{p+1}}) \\ \alpha'_{2p+2,q_p} &= \text{perturbation of } \beta_{q_p} * \psi'_{2p+2,q_p}(\beta'_{q_p}). \end{aligned}$$

So, from the definition of  $\alpha_{2p+2,q_p}$  and  $\alpha_{2p+2,q_{p+1}}$ ,

$$\beta_{q_{p+1}} * \psi'_{2p+2,q_p}(\overline{\beta'_{q_{p+1}}} * \beta'_{q_p}) * \overline{\beta_{q_p}} = \beta_{q_{p+1}} * \psi_{2p+2,q_p}(\overline{\beta_{1-q_{p+1}}} * \beta_{1-q_p}) * \overline{\beta_{q_p}}.$$

So this gives

$$\psi'_{2p+2,q_p}(\overline{\beta'_{q_{p+1}}} * \beta'_{q_p}) = \overline{\beta_{1-q_{p+1}}} * \beta_{1-q_p}.$$

Then (7.3.5) gives  $\beta'_{q_{p+1}} = \beta_{1-q_{p+1}}$ , as required. Now (7.3.3) for  $m = 2p + 2$  and  $q_{p+1}$  follows from the definition of  $\alpha'_{2p+2, q_{p+1}}$  and (7.3.3) for  $m = 2p + 2$  and  $q_p$ . Also, (7.3.4) for  $m = 2p + 2$  and  $q_{p+1}$  follows from (3.3.8):

$$[\psi_{2p+2, q_{p+1}}] = [\psi_{2p+2, q_p}] \text{ in } \text{MG}(\overline{\mathbb{C}}, Y_{2p+3}).$$

Now we prove (7.3.4) and (7.3.3) for  $q_{p+1}$  and  $m = 2p + 3$ . Write  $r = q_{p+1}$  and  $q = q_p$ . We have, since  $\psi'_{2p+2, r} = \psi'_{2p+2, q}$ :

$$\sigma_{\alpha'_{2p+2, r}} \circ s \circ \psi'_{2p+3, r} = \psi'_{2p+2, q} \circ s.$$

But from what we have for  $m = 2p + 2$ , this gives

$$\sigma_{\alpha_{2p+2, r}} \circ s \circ \psi'_{2p+3, r} = \psi_{2p+2, q} \circ s \text{ rel } Y_{2p+4}.$$

Since  $\psi'_{2p+3, r} = \psi'_{2p+2, r}$  relative to  $Y_{2p+3}$  and the same equation is solved by  $\psi_{2p+3, r}$  relative to  $Y_{2p+3}$ , we obtain

$$\psi'_{2p+3, q_{p+1}} = \psi_{2p+3, q_{p+1}} \text{ in } \text{MG}(\overline{\mathbb{C}}, Y_{2p+4}).$$

Then we obtain, from the definition,

$$\alpha'_{2p+3, q_{p+1}} = \alpha_{2p+3, q_{p+1}} \text{ in } \pi_1(\overline{\mathbb{C}} \setminus Z_{2p+4}, v_2).$$

In exactly the same way, we obtain (7.3.3) and (7.3.4) for  $q_{p+1}$  and  $m \geq 2p + 4$ .

Finally, we consider (7.3.5) for  $q_{p+1}$ . Write

$$\psi'_{m, q_k} = \xi''_{m, q_k} \circ \psi_{m, q_k},$$

for  $k = p$  and  $p + 1$ . Write

$$X_1 = \overline{\beta_{q_{p+1}}} * \beta_{q_p} \cup s^{-1}(\overline{\beta_{q_p}} * \beta_{q_{p-1}}),$$

$$X_2 = \overline{\beta_{q_{p+2}}} * \beta_{q_{p+1}} \cup s^{-1}(\overline{\beta_{q_{p+1}}} * \beta_{q_p}).$$

Since the support of  $\psi_{2p+4, q_{p+1}}$  is disjoint from  $X_2$ , it suffices to show that  $\xi''_{2p+4, q_{p+1}}$  is disjoint from  $X_2$ . Define  $\psi''_{m, q_p}$  for  $2p + 2 \leq m \leq 2p + 4$  by

$$\psi''_{2p+2, q_p} = \psi_{2p+2, q_p},$$

and for  $m = 2p + 3$  and  $m = 2p + 2$ ,  $\psi''_{m, q_p}$  is isotopic to  $\psi_{2p+2, q_p}$  relative to  $Y_{2p+2}$ , and for  $r = q_{p+1}$ ,

$$\sigma_{\alpha_{m-1, r}} \circ s \circ \psi''_{m, q_p} = \psi''_{m-1, q_p} \circ s.$$

But for  $k = 2p + 3$  or  $2p + 4$ , we can write

$$\xi''_{k, q_{p+1}} = \xi''_{k, q_{p+1}, 1} \circ \xi''_{k, q_{p+1}, 2},$$

where

$$\psi'_{k, q_{p+1}} = \xi''_{k, q_{p+1}, 1} \circ \psi''_{k, q_p}$$

and

$$\psi''_{k, q_p} = \xi''_{k, q_{p+1}, 2} \circ \psi_{k, q_{p+1}}.$$

Now the support of  $\xi''_{k,q_{p+1},1}$  is contained in the preimage under  $(\sigma_{\beta_r} \circ s)^{k-2p-2}$  of the support of  $\xi''_{2p+2,q_p}$ . Since the support of  $\xi''_{2p+2,q_p}$  is disjoint from  $X_1$ , the support of  $\xi''_{2p+3,q_{p+1},1}$  is disjoint from  $\overline{\beta_{q_{p+1}}} * \beta_{q_p}$ . The support of  $\psi_{2p+3,q_{p+1}}$  is the preimage under  $\sigma_{\beta_r} \circ s$  of an annulus which intersects the unit disc between the leaves with endpoints  $e^{\pm 2\pi i q_{p+1}}$  and  $e^{\pm 4\pi i q_{p+1}}$ . The preimage is disjoint from  $X_2$ . So now the supports of  $\xi''_{2p+4,q_{p+1},1}$  and  $\xi''_{2p+4,2}$  are obtained by taking preimages under  $\sigma_{\beta_r} \circ s$  again, and must be disjoint from  $X_2$ .

This completes the proof of (7.3.5) for  $q_{p+1}$ . □

### 7.4. Hard part of the fundamental domain: the first few cases

In this subsection, we describe the part of the fundamental domain corresponding to  $V_{3,m}(a_1, +)$  for  $m \leq 5$ , with some partial information in the cases  $m = 6, 7$ . To do this, we shall describe the set  $\Omega_m(a_1, +)$  in terms of its image  $R_m(a_1, +)$  under  $\rho$ . Three paths in  $\Omega_m(a_1, +)$  (for any  $m$ ) have already been chosen:  $\omega_1$ ,  $\omega'_1$  and  $\omega_\infty$ . The images under  $\rho(\cdot, s)$  are, respectively,  $\beta_{2/7}$ ,  $\beta_{5/7}$  and  $\beta_{1/3}$ , or equivalently,  $\beta_{2/3}$ , since  $\beta_{1/3}$  and  $\beta_{2/3}$  are homotopic under a homotopy moving the second endpoint along  $\gamma_{1/3}$ . Here,  $\gamma_{1/3}$  denotes the closed loop  $\ell_{1/3} \cup \ell_{1/3}^{-1}$ , where  $\ell_{1/3}$  is the leaf of  $L_{3/7}$  with endpoints  $e^{\pm 2\pi i(1/3)}$ . As in the proof of the easy cases in 6.3, we need to describe matched pairs of adjacent pairs in  $R_m(a_1, +)$ . As in (6.3.1), the adjacent pairs  $(\beta_1, \beta_2)$  and  $(\beta'_1, \beta'_2)$  in  $R_m(a_1, +)$  are matched if there is  $[\psi] \in \text{MG}(\overline{\mathbb{C}}, Y_m(s))$  and  $\alpha \in \pi_1(\overline{\mathbb{C}} \setminus Z_m(s), v_2)$  such that

$$(7.4.1) \quad \begin{aligned} (s, Y_m(s)) &\simeq_\psi (\sigma_\alpha \circ s, Y_m(s)) \\ \beta_i &= \alpha * \psi(\beta'_i) \text{ rel } Y_m(s), \quad i = 1, 2 \end{aligned}$$

In particular,  $\overline{\beta_1} * \beta_2$  and  $\psi(\overline{\beta'_1} * \beta'_2)$  are homotopic via a homotopy preserving  $Z_m$ . We are going to try to make choices so that  $\overline{\beta_1} * \beta_2$  and  $\psi(\overline{\beta'_1} * \beta'_2)$  are disjoint arcs, after arbitrarily small perturbation near  $v_2$ , bounding an open disc disjoint from  $m$ .

If  $(\beta_{2/7}, \beta_2)$  and  $(\beta_{5/7}, \beta'_2)$  are adjacent pairs in  $R_m(a_1, +)$ , then these are always matched by  $[\psi] = [\psi_{m,2/7}]$  and  $\alpha = \alpha_{m,2/7}$ , where  $\alpha_{m,2/7}$  and  $\psi_{m,2/7}$  are as in 7.2. For  $m \leq 2$ ,  $\psi_{m,2/7}$  is the identity on  $\beta_{5/7}$  and  $\alpha_{m,2/7}$  is an arbitrarily small perturbation of  $\beta_{2/7} * \psi_{m,2/7}(\beta_{5/7})$ .

We are now ready to start an inductive construction of  $R_m(a_1, +)$  with a matching of pairs of adjacent pairs. After homotopy preserving endpoints if necessary,  $\beta_{2/7}$  and  $\beta_{5/7}$  are disjoint from  $\gamma_{1/3}$  and also from  $\beta_{1/3}$ , apart from the common endpoint at  $v_2$ . Also, after homotopy preserving endpoints if necessary,  $\beta_{1/3}$  is disjoint from  $\gamma_{1/3}$ , apart from the second endpoint being in  $\gamma_{1/3}$ . Then  $\beta_{2/7} \cup \beta_{5/7} \cup \beta_{1/3} \cup \gamma_{1/3}$  bounds an open topological disc containing just one point of  $Z_2(s)$ , namely the common endpoint of  $\beta_{9/28}$  and  $\beta_{19/28}$ . (The boundary of this disc is not an embedded circle.) Also,  $\psi_{2,2/7}$

fixes both  $\beta_{5/7}$  and  $\beta_{2/7}$ , and  $\psi_{2,2/7}(\beta_{2/3})$  is homotopic to  $\beta_{2/3}$  via a homotopy fixing endpoints and  $Z_2$ . Moreover, (7.4.1) holds for  $m = 2$ , and

$$(\beta_1, \beta_2) = (\beta_{2/7}, \beta_{9/28}), \quad (\beta'_1, \beta'_2) = (\beta_{5/7}, \beta_{19/28}), \quad \alpha = \alpha_{2,2/7}, \quad \psi = \psi_{2,2/7},$$

and also for

$$(\beta_1, \beta_2) = (\beta_{9/28}, \beta_{1/3}), \quad (\beta'_1, \beta'_2) = (\beta_{19/28}, \beta_{1/3}), \quad \alpha = \alpha_{2,9/28}, \quad \psi = \psi_{2,2/7}.$$

So then we can define

$$R_2(a_1, +) = \{\beta_{2/7}, \beta_{5/7}, \beta_{9/28}, \beta_{19/28}, \beta_{1/3}\},$$

where the adjacent pair  $(\beta_{2/7}, \beta_{9/28})$  is matched with the adjacent pair  $(\beta_{5/7}, \beta_{19/28})$ , and the adjacent pair  $(\beta_{9/28}, \beta_{1/3})$  is matched with the adjacent pair  $(\beta_{19/28}, \beta_{1/3})$ . The set  $U(\beta_{2/7}, \beta_{9/28})$ , bounded by  $\overline{\beta_{2/7}} * \beta_{9/28}$  and

$$\overline{\beta_{5/7}} * \beta_{19/28} = \psi_{2,2/7}(\overline{\beta_{5/7}} * \beta_{19/28}),$$

is shown below, up to homotopy preserving  $Z_2$ , with  $\overline{\beta_{2/7}} * \beta_{9/28}$  (up to homotopy) indicated by solid line and  $\overline{\beta_{5/7}} * \beta_{19/28}$  (up to homotopy) indicated by dashed line. The unit circle and some lamination leaves are indicated by dotted lines.

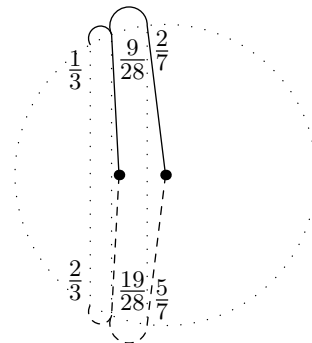

Now we want to choose  $R_3(a_1, +)$ , containing  $R_2(a_1, +)$  up to homotopy preserving  $Y_3(s)$ . We take the loop  $\alpha$  as in (7.4.1) to be an arbitrarily small neighborhood of  $\beta_{2/7} * \psi_{2,2/7}(\overline{\beta_{5/7}})$ . Then the homeomorphism  $\psi$  used as in (7.4.1) for matching adjacent pairs between  $\beta_{5/7}$  and  $\beta_{19/28}$  with adjacent pairs between  $\beta_{2/7}$  and  $\beta_{9/28}$ , is  $\psi_{3,2/7}$ , up to isotopy preserving  $Y_3(s)$ . Because of this, we consider the region bounded by  $\overline{\beta_{9/28}} * \beta_{2/7}$  and  $\psi_{3,2/7}(\overline{\beta_{19/28}} * \beta_{5/7})$ , up to homotopy relative to  $Z_3(s)$ . So, since  $\psi_{3,2/7} = \xi_{2,2/7} \circ \psi_{2,2/7}$ , we need to consider the image of  $\psi_{2,2/7}(\overline{\beta_{19/28}} * \beta_{5/7})$  under  $\xi_{2,2/7}$ . The support of  $\xi_{2,2/7}$  is  $A_{2,2/7} \cup C_{2,2/7}$ . The annulus  $A_{2,2/7}$  does not intersect  $\psi_{2,2/7}(\overline{\beta_{19/28}} * \beta_{5/7})$  up to homotopy preserving  $Z_3(s)$ , but  $C_{2,2/7}$  does. So  $\psi_{3,2/7}(\overline{\beta_{19/28}} * \beta_{5/7})$  has a bulge into the lower half of the unit disc between the two leaves of  $L_{3/7}$  with endpoints at  $e^{\pm 2\pi i(2/7)}$  and  $e^{\pm 2\pi i(3/14)}$ . This bulge contains a point of  $Z_3(s)$  with symbolic code  $w_1 = BCL_1R_1R_2C$  (using the symbolic dynamics and conventions of 2.9). We

therefore need to divide the region bounded by  $\overline{\beta_{9/28} * \beta_{2/7}}$  and  $\psi_{3,2/7}(\overline{\beta_{19/28} * \beta_{5/7}})$  into two, by defining two more paths in  $R_3(a_1, +)$ , which we call  $\beta(w_1)$  and  $\beta'(w'_1)$ , for  $w'_1 = UCL_1R_1R_2C$ . It will turn out later that this notation is valid: no other path in  $\cup_p R_{m,p}$  will have endpoint at the point of  $Z_3$  labelled by  $w_1$ . Now  $R_3(a_1, +)$  is simply the union of  $R_2(a_1, +)$  and  $\beta(w_1)$  and  $\beta'(w'_1)$ . Below is the sketch of the two regions  $U(\beta_{2/7}, \beta(w_1))$  and  $U(\beta(w_1), \beta_{9/28})$ , one bounded by  $\overline{\beta(w_1) * \beta_{2/7}}$  and  $\psi_{3,2/7}(\overline{\beta'(w'_1) * \beta_{5/7}})$  and the other bounded by  $\overline{\beta_{9/28} * \beta(w_1)}$  and  $\psi_{3,2/7}(\overline{\beta_{19/28} * \beta'(w'_1)})$ .

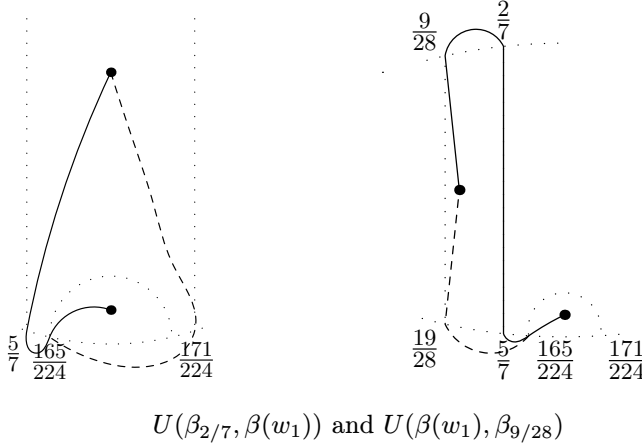

The critically finite map represented by  $\beta(w_1)$  is not Thurston-equivalent to any capture, as is demonstrated by the comparison between the capture numbers and expected value of  $\#(P'_3(1))$ , the deficit in the third number in the sequence, noted after (3.4.5). The point  $e^{2\pi i(165/224)}$  is not a point of lowest preperiod under  $z \mapsto z^2$  in the boundary of the gap containing the endpoint of  $\beta(w_1)$ . The points of lowest preperiod are actually  $e^{2\pi i(41/56)}$  and  $e^{2\pi i(43/56)}$ . The rule will be specified later, but the last  $S^1$  crossing points of paths of  $R_m(a_1, +)$ , for any  $m$ , are always in the backward orbit of  $e^{2\pi i(2/7)}$ . For the matching pair  $(\beta_{9/28}, \beta_{1/3})$  and  $(\beta_{19/28}, \beta_{1/3})$ , we use the homeomorphism  $\psi'_{3,9/28}$  of 7.3 to effect the matching. Thus,

$$\sigma_{\alpha_{2,9/28}} \circ s \circ \psi'_{3,9/28} = \psi_{2,2/7} \circ s.$$

Then  $\psi'_{3,9/28}(\overline{\beta_{1/3} * \beta_{19/28}})$  and  $\psi_{3,9/28}(\overline{\beta_{1/3} * \beta_{19/28}})$  are homotopic up to homotopy preserving  $Z_3(s)$ , and the region bounded by  $\overline{\beta_{1/3} * \beta_{9/28}}$  and  $\psi'_{3,9/28}(\overline{\beta_{1/3} * \beta_{19/28}})$  contains no points of  $Z_3(s)$  in its interior. So we do not have to subdivide the region bounded by  $\overline{\beta_{1/3} * \beta_{9/28}}$  and  $\psi'_{3,9/28}(\overline{\beta_{1/3} * \beta_{19/28}})$ . The paths  $\beta(w_1)$ , and  $\beta'(w'_1)$  are indeed the only ones we need to add to  $R_2(a_1, +)$  to produce  $R_3(a_1, +)$ .

So far,  $R_m(a_1, +) \setminus \{\beta_{1/3}\}$  is a union of two sets, such that each path in the first set is matched with a path in the second, and the matching of adjacent pairs is effected by this matching of individual paths. For example, in  $R_3(a_1, +)$ , the path  $\beta_{2/7}$  is

matched with  $\beta_{5/7}$ , and  $\beta(w_1)$  with  $\beta'(w'_1)$ , and  $\beta_{9/28}$  with  $\beta_{19/28}$ . This matching will continue. We continue trying to subdivide the regions bounded by  $\overline{\beta_2} * \beta_1$  and  $\psi_{m+1}(\overline{\beta'_1} * \beta'_2)$  in  $R_m(a_1, +)$  for matching adjacent pairs  $(\beta_1, \beta_2)$  and  $(\beta'_1, \beta'_2)$ , where  $\psi_m$  and  $\alpha_m$  satisfy (7.4.1), with  $\psi_m$  and  $\alpha_m$  replacing  $\psi$  and  $\alpha$ , and  $\psi_{m+1}$  is defined by  $[\psi_{m+1}] = [\psi_m]$  in  $\text{MG}(\overline{\mathbb{C}}, Y_m)$  and

$$(7.4.2) \quad \sigma_{\alpha_m} \circ s \circ \psi_{m+1} = \psi_m \circ s.$$

At each stage there is a choice to be made for the loop  $\alpha_m$  for an adjacent pair  $(\beta_1, \beta_2)$ , where  $\beta_1$  is nearer to  $\beta_{2/7}$  than  $\beta_2$ . We shall always take  $\alpha_m$  to be an arbitrarily small perturbation of  $\beta_1 * \psi_m(\overline{\beta'_1})$ , so that  $\alpha_m$  is also homotopic, up to homotopy preserving  $Y_m$ , to an arbitrarily small perturbation of  $\beta_2 * \psi_m(\overline{\beta'_2})$ . We write  $U(\beta_1, \beta_2)$  for the region bounded by arbitrarily small perturbations of  $\beta_1 * \overline{\beta_2}$  and  $\psi_m(\overline{\beta'_1} * \overline{\beta'_2})$  up to  $Z_m$ -preserving homotopy, where the perturbations are chosen so that  $U(\beta_1, \beta_2)$  does not contain  $v_2$  and can be homotoped into  $\{z : |z| \leq 1\}$  in the complement of  $v_2$ . We denote by  $\partial'U(\beta_1, \beta_2)$  the part of the boundary of  $\partial U(\beta_1, \beta_2)$  which is homotopic to an arbitrarily small perturbation of  $\psi_m(\overline{\beta'_1} * \overline{\beta'_2})$ .

So, following this procedure, we next insert paths of  $R_4(a_1, +) \setminus R_3(a_1, +)$  between adjacent paths in  $R_3(a_1, +)$ , where necessary. The sets  $U(\beta_1, \beta_2)$  for adjacent pairs  $(\beta_1, \beta_2)$  between  $\beta_{2/7}$  and  $\beta_{9/28}$  are shown in the pictures below.

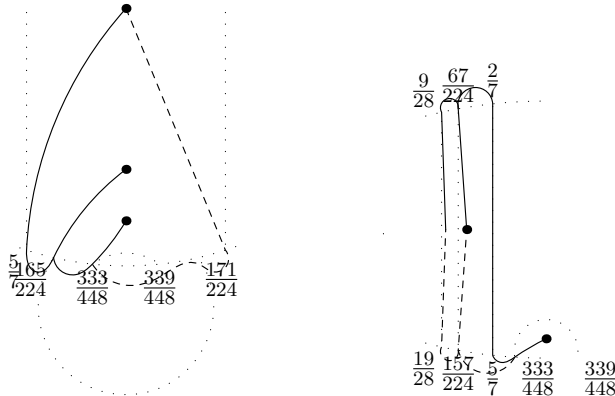

We label each path by the word representing its second endpoint, using the convention of 2.9. There are two new paths  $\beta(w_2)$  and  $\beta(w_3)$  between  $\beta(w_1)$  and  $\beta_{9/28}$ , with  $w_2 = BCL_1R_1^2R_2C$  and  $w_3 = L_3L_2R_3L_2C$ . The path  $\beta(w_3)$  is actually  $\beta_{67/224}$ . The point of lowest preperiod on the top boundary of the gap is  $e^{2\pi i(33/112)}$ , but we want to keep to the rule that  $S^1$ -crossing points are in the backward orbit of  $e^{2\pi i(2/7)}$ . There are corresponding paths  $\beta'(w'_2)$  and  $\beta'(w'_3)$  between  $\beta'(w'_1)$  and  $\beta_{19/28}$  with  $w'_2 = UCL_1R_1^2R_2C$  and  $w'_3 = w_3$ , such that  $(\beta(w_1), \beta(w_2))$  is matched with

$(\beta'(w'_1), \beta'(w'_2))$ , and  $(\beta(w_2), \beta(w_3))$  is matched with  $(\beta'(w'_2), \beta(w'_3))$ . The path  $\beta'(w'_3)$  is  $\beta_{157/224}$ . We have  $w'_3 = w_3$  because  $\psi_{4,2/7}$  fixes  $D(w_3)$ . Although  $\beta(w_2)$  is between  $\beta(w_1)$  and  $\beta_{9/28}$ , we have

$$U(\beta(w_1), \beta(w_2)) \subset U(\beta_{2/7}, \beta(w_1)).$$

There are two remaining paths in  $R_4(a_1, +) \setminus R_3(a_1, +)$ , which are  $\beta_{37/112}$  and  $\beta_{75/112}$ . The adjacent pair  $(\beta_{9/28}, \beta_{37/112})$  is matched with the adjacent pair  $(\beta_{19/28}, \beta_{75/112})$ , and the adjacent pair  $(\beta_{37/112}, \beta_{1/3})$  is matched with the adjacent pair  $(\beta_{75/112}, \beta_{1/3})$ . The dashed boundary  $\partial'U(\beta_{9/28}, \beta_{37/112})$  is simply an arbitrarily small perturbation of  $\overline{\beta_{19/28}} * \beta_{75/112}$ , up to homotopy preserving  $Z_4$ .

So far, the matching of adjacent pairs in  $R_m(a_1, +)$  has been induced by a matching of each path in  $R_m(a_1, +) \setminus \{\beta_{1/3}\}$  with exactly one other path in  $R_m(a_1, +) \setminus \{\beta_{1/3}\}$ . This means that, so far, the tree in  $V_{3,m}(a_1, +) \cup P_{3,m}(a_1, +)$  which is dual to  $\cup\Omega_m(a_1, +)$  is simply an interval made up of edges between vertices in  $P_m(a_1, +)$ . It is reasonable to attempt to continue this pattern, and we shall do so. So we aim to define  $R_m(a_1, +)$  so that

$$R_m(a_1, +) = \cup_{0 \leq p, 2p \leq m} R_{m,p} \cup R'_{m,p} \cup \{\beta_{1/3}\},$$

where  $R_{m,p}$  is the set of paths between  $\beta_{q_p}$  and  $\beta_{q_{p+1}}$ , and

$$(7.4.3) \quad R_{m,p} \cap R'_{m,q} = \emptyset$$

for all  $p$  and  $q$ , and if  $2p + 2 \leq m$ , then

$$(7.4.4) \quad R_{m,p} \cap R_{m,p+1} = \{\beta_{q_{p+1}}\},$$

$$(7.4.5) \quad R'_{m,p} \cap R'_{m,p+1} = \{\beta_{1-q_{p+1}}\} \text{ rel } Y_{2p+2},$$

$$(7.4.6) \quad \beta_{2/7} \in R_{m,0}, \quad \beta_{5/7} \in R'_{m,0}.$$

We shall also aim to have

$$(7.4.7) \quad R_m(a_1, +) \subset R_{m+1}(a_1, +) \text{ rel } Y_n \text{ for all } n \geq 0.$$

Now we consider  $R_{5,0}$ . For any pair  $(\beta_1, \beta_2)$  in  $R_{4,0}$ , it can be shown that the corresponding homeomorphisms  $\psi_4$  and  $\psi_5$  coincide with  $\psi_{4,2/7}$  and  $\psi_{5,2/7}$  on  $\overline{\beta'_1} * \beta'_2$ , for the matching pair  $(\beta'_1, \beta'_2)$ . (We shall prove such results later.) The definition of  $\psi_{m+1}$  in terms of  $\alpha_m$  and  $\psi_m$  is given in (7.4.2) with  $\psi_0 = \psi_{0,2/7}$ . The definition of  $\alpha_m$  in terms of  $\psi_m, \beta_1$  and  $\beta'_1$ , for an adjacent pair  $(\beta_1, \beta_2)$  in  $\cup_p R_{m,p}$ , matched with an adjacent pair  $(\beta'_1, \beta'_2)$  in  $\cup_p R'_{m,p}$ , is given immediately after (7.4.2). Then, if we write  $\psi_5 = \xi_4 \circ \psi_4$ , we have

$$\xi_4 = \xi_{4,2/7} \text{ on } \partial'U(\beta_1, \beta_2).$$

The support of  $\xi_{4,2/7}$  is the union of  $A_{4,2/7}$  and  $C_{4,2/7}$ , each of these being a union of disjoint annuli. One annulus from  $A_{4,2/7}$  intersects  $\partial'U(\beta(w_2), \beta(w_3))$ , and one annulus from  $C_{4,2/7}$  intersects  $\partial'U(\beta(w_3), \beta_{9/28})$ . Otherwise, the support has no intersection with the sets  $\partial'U(\beta_1, \beta_2)$  for adjacent pairs  $(\beta_1, \beta_2)$  in  $R_{4,0}$ . The part of  $A_{4,2/7}$  which intersects  $\partial'U(\beta(w_2), \beta(w_3))$  is

$$L_3L_2R_3L_3 \rightarrow L_3^4,$$

and the part of  $C_{4,2/7}$  which intersects  $\partial'U(\beta(w_3), \beta_{9/28})$  is

$$L_3L_2UC \rightarrow L_3L_2BC.$$

We now draw the image under  $\xi_{4,2/7}$  of the dashed boundary of  $U = U(\beta(w_2), \beta(w_3))$ , which uses the intersection with  $A_{4,2/7}$ .

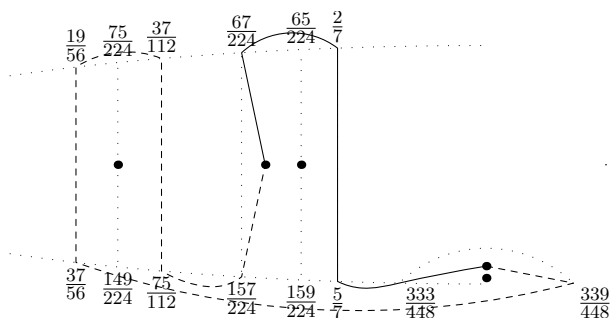

Image under  $\xi_{4,2/7}$

The region bounded by  $\overline{\beta(w_2) * \beta(w_3)}$  and  $\xi_{4,2/7}(\partial'U)$  contains three points of  $Z_5 \setminus Z_4$ , with words

$$w_5 = BCL_1R_1^3R_2C, \quad w_6 = L_3^4L_2C, \quad w_7 = L_3L_2R_3L_3L_2C.$$

The region bounded by  $\overline{\beta_{2/7} * \beta(w_2)}$  and  $\xi_{4,2/7}(\partial'U(\beta_{2/7}, \beta(w_2)))$  also contains one point of  $Z_5 \setminus Z_4$ , with word  $w_4 = BCL_1R_2R_3L_2C$ . The region bounded by  $\overline{\beta(w_3) * \beta_{9/28}}$  and  $\xi_{4,2/7}(\partial'U(\beta(w_3), \beta_{9/28}))$  contains one point of  $Z_5 \setminus Z_4$  with the word  $w_8 = L_3L_2UCL_1R_1R_2C$ . Then

$$R_{5,0} \setminus R_{4,0} = \{\beta(w_4), \beta(w_5), \beta(w_6), \beta(w_7), \beta(w_8)\}.$$

In all these cases,  $\beta(w_i)$  is the only path in  $R_{5,0}$  (and also, it turns out, the only such path in  $\cup_p R_{5,p}$ ) with endpoint coded by  $w_i$ . Correspondingly,

$$R'_{5,0} \setminus R'_{4,0} = \{\beta'(w'_4), \beta'(w'_5), \beta'(w'_6), \beta'(w'_7), \beta'(w'_8)\},$$

where:

$$w'_4 = UCL_1R_2R_3L_2C, \quad w'_5 = UCL_1R_1^3R_2C, \quad w'_6 = w_7 = L_3L_2R_3L_3L_2C, \\ w'_7 = L_2R_3L_3^2L_2C, \quad w'_8 = L_3L_2BCL_1R_1R_2C.$$



Now we draw  $U(\beta_1, \beta_2)$  for adjacent pairs  $(\beta_1, \beta_2)$  from  $R_{5,0}$ .

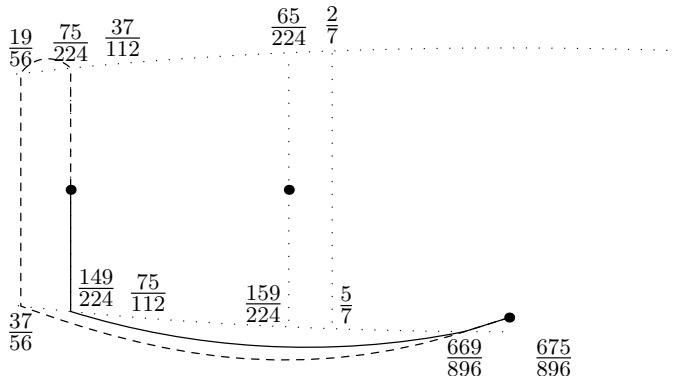

$U(\beta(w_5), \beta(w_6))$

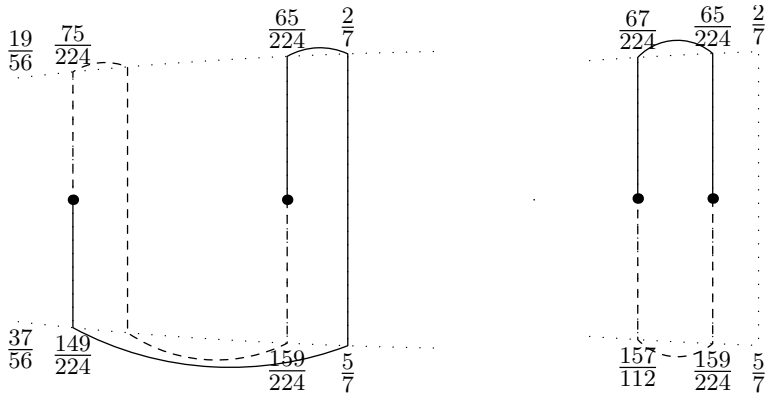

$U(\beta(w_6), \beta(w_7))$  and  $U(\beta(w_7), \beta(w_3))$ .

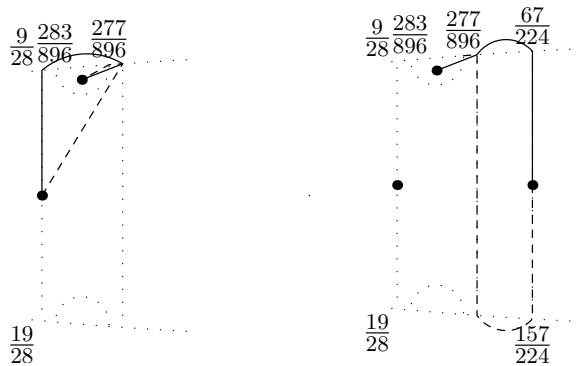

$U(\beta(w_8), \beta_{9/28})$  and  $U(\beta(w_7), \beta(w_8))$

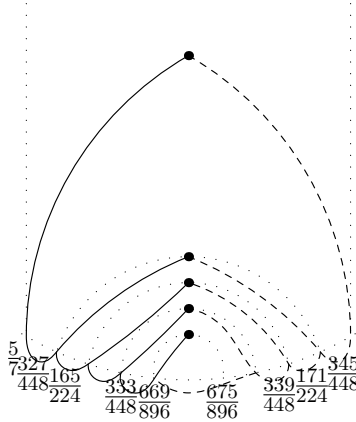

$$U(\beta_{2/7}, \beta(w_4)), U(\beta(w_4), \beta(w_1)), U(\beta(w_1), \beta(w_2)) \text{ and } U(\beta(w_2), \beta(w_5))$$

Note that, similarly to what happened with  $\beta(w_2)$ , although  $\beta(w_5)$  is between  $\beta(w_2)$  and  $\beta(w_3)$ , for the adjacent pair  $(\beta(w_2), \beta(w_5))$ , we have

$$U(\beta(w_2), \beta(w_5)) \subset U(\beta(w_1), \beta(w_2)).$$

Note, also, that  $U(\beta(w_6), \beta(w_7))$  has two essential components of intersection with  $\{z : |z| < 1\}$ , which has not happened before. The reason for this becomes partially apparent when considering the image under  $\xi_5$ , which, as with  $\xi_4$ , coincides with  $\xi_{5,2/7}$ . The region bounded by  $\overline{\beta(w_6)} * \beta(w_7)$  and  $\xi_{5,2/7}(\partial' U(\beta(w_6), \beta(w_7)))$  again has two components of intersection, but overall the picture is simpler than it would have been if  $U(\beta(w_6), \beta(w_7))$  had been chosen to have just one essential component of intersection with  $\{z : |z| < 1\}$ , adjacent to the endpoint of  $\beta(w_5)$ , which might seem to be the more natural choice.

Note, also, that  $\beta(w_7) = \beta_{65/224} \in R_{5,0}$  is matched with  $\beta'(w'_7)$ , where  $w'_7 = L_2 R_3 L_3^2 L_2 C$ , and  $\beta(w_6)$  is matched with  $\beta'(w'_6) = \beta'(w_7)$ , which is, in fact, equal to  $\beta_{159/224}$ . For each matched  $\beta$  and  $\beta'$ , the maps  $\sigma_\beta \circ s$  and  $\sigma_{\beta'} \circ s$  are Thurston equivalent. In particular,  $\sigma_{159/224} \circ s$  is Thurston equivalent to  $\sigma_{\beta(w_6)} \circ s$ . Since  $R_5(a_1, +)$ , together with the sets  $R_5(a_1, -)$  and  $R_5(a_0)$  and  $R_5(\overline{a_0})$ , determines a fundamental domain for  $V_{3,5}$ , and since  $\beta_{65/224}$  and  $\beta_{159/224}$  determine non-matched vertices of the fundamental domain, the two captures  $\sigma_{65/224} \circ s$  and  $\sigma_{159/225} \circ s$  are not Thurston equivalent. This is the first stage at which captures  $\sigma_q \circ s$  and  $\sigma_{1-q} \circ s$  are not Thurston equivalent even though  $q$  and  $1 - q$  are endpoints of the same lamination leaf: for  $q = \frac{65}{224}$ . The path  $\beta(w_6) = \beta(L_3^4 L_2 C)$ , which is not a capture path, is drawn below.

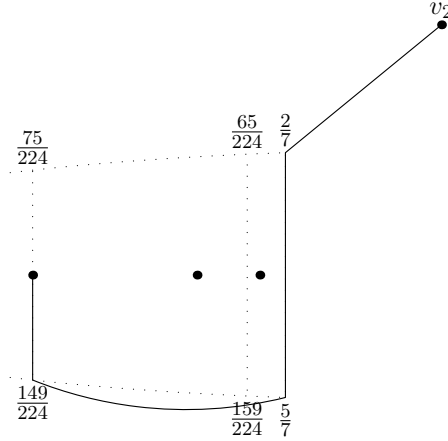

The path  $\beta(w_6)$

There is one path in  $R_{5,1}$  between  $\beta_{9/28}$  and  $\beta_{37/112}$ , which we call  $\beta(w_9)$ , with  $w_9 = L_3L_2BCL_1R_2C$ . This path is matched with  $\beta'(w'_9)$  in  $R'_{5,1}$  between  $\beta_{19/28}$  and  $\beta_{75/112}$ , where  $w'_9 = w_8 = L_3L_2UCL_1R_2C$ .

We now consider the case  $m = 6$ . We list all words corresponding to points in  $U^0$  of preperiod 6, remembering that the word corresponding to a point of preperiod  $m$  has length  $m + 1$  or  $m + 2$  and ends in  $C$ . For preperiod 6, it is still true that each word corresponds to exactly one path. There are nine words, split between those ending in  $R_1R_2C$  and those ending in  $L_2C$ :

$$(7.4.8) \quad \begin{aligned} w_{10} &= BCL_1R_1^4R_2C, & w_{11} &= BCL_1R_2BCL_1R_1R_2C, \\ w_{12} &= BCL_1R_2UCL_1R_1R_2C & w_{13} &= L_3L_2UCL_1R_1^2R_2C, \\ w_{14} &= L_3^2L_2BCL_1R_1R_2C, \end{aligned}$$

$$(7.4.9) \quad \begin{aligned} w_{15} &= BCL_1R_2R_3L_3L_2C, & w_{16} &= L_3(L_2R_3)^2L_2C, \\ w_{17} &= L_3L_2R_3L_3^2L_2C, & w_{18} &= BCL_1R_1R_2R_3L_3L_2C. \end{aligned}$$

We note that there are also 2 preperiod 6 words corresponding to  $U^1$ :

$$w_{19} = L_3^3L_2R_3L_2C, \quad w_{20} = L_3L_2BCL_1R_1^2R_2C,$$

and one corresponding to  $U^2$ ,

$$w_{21} = L_3^5L_2C.$$

As with the previous cases, the construction of  $R_6(a_1, +)$  and  $R'_6(a_1, +)$  is effected by the action of the maps  $\xi_5$  on sets  $\partial'U(\beta_1, \beta_2)$  for adjacent pairs  $(\beta_1, \beta_2)$  in  $R_5(a_1, +)$ . We cannot expect, at this stage, that  $\xi_5$  is always equal to  $\xi_{5,2/7}$  on  $\partial'U(\beta_1, \beta_2)$ , especially if  $\beta_1$  and  $\beta_2$  are relatively far from  $\beta_{2/7}$ .

In some cases, we may want to redraw the paths of  $R'_m(a_1, +)$  up to finer isotopy preserving  $Y_{m+1}$ . This is permissible, but will, of course, affect the definitions of homeomorphisms  $\xi_n$  for  $n \geq m + 1$ . We have not, of course, drawn the paths of  $R'_m(a_1, +)$  explicitly, but their definitions up to isotopy preserving  $Y_m$  are given by the sets  $\partial'U(\beta_1, \beta_2)$ , for adjacent pairs  $(\beta_1, \beta_2)$  in  $R_m(a_1, +)$ . An example is given by the adjacent pairs  $(\beta_{2/7}, \beta(w_4))$  and  $(\beta(w_5), \beta(w_6))$  in  $R'_{5,0}$ . Let  $\psi_{5,j}$  and  $\psi_{6,j}$ , for  $j = 1$  and  $2$ , be the homeomorphisms for these respective adjacent pairs, which are determined up to isotopy preserving  $Y_5$  and  $Y_6$ . We have  $\psi_{5,1} = \psi_{5,2/7}$  up to isotopy preserving  $Y_5$  and  $\psi_{6,1} = \psi_{6,2/7}$  on  $\partial'U(\beta_{2/7}, \beta(w_4))$  up to isotopy preserving  $Y_6$ , and similarly for  $\psi_{5,2}$  and  $\psi_{6,2}$  on  $\partial'U(\beta(w_5), \beta(w_6))$ . So we can define  $\psi_{5,j} = \psi_{5,2/7}$  pointwise and  $\psi_{6,j} = \psi_{6,2/7}$ , for both  $j = 1$  and  $2$ . So then we have  $\psi_{6,j} = \xi_{5,2/7} \circ \psi_{5,j}$ . But if we look of the image of the two sets  $\partial'U(\beta_{2/7}, \beta(w_4))$  and  $\partial'U(\beta(w_5), \beta(w_6))$ , as originally drawn under  $\xi_{5,2/7}$ , they are complicated, because of the nature of the intersection of  $A_{5,2/7} \cup C_{5,2/7}$  with  $\partial'U(\beta_{2/7}, \beta(w_4))$  and  $\partial'U(\beta(w_5), \beta(w_6))$ . We concentrate first on the intersection with  $C_{5,2/7}$ . To simplify the images, we simply change the sets  $\partial'U(\beta_{2/7}, \beta(w_4))$  and  $\partial'U(\beta(w_5), \beta(w_6))$ , keeping the same sets up to homotopy preserving  $Y_5$ , but not up to homotopy preserving  $Y_6$ . We create an extra “hook” in the set  $\partial'U(\beta(w_5), \beta(w_6))$ , so that the set  $U(\beta(w_5), \beta(w_6))$  is increased at the expense of  $U(\beta_{2/7}, \beta(w_4))$ . This means that we have to redraw the paths  $\beta'(w'_5)$  and  $\beta'(w'_4)$ , and, in consequence, the paths in  $R_5(a_1, +)$  between them also, that is,  $\beta'(w'_1)$  and  $\beta'(w'_2)$ . Below, we draw the modified set  $\partial'U(\beta(w_5), \beta(w_6))$  shown by the dashed lines, and also the modified path  $\beta'(w'_5)$ .

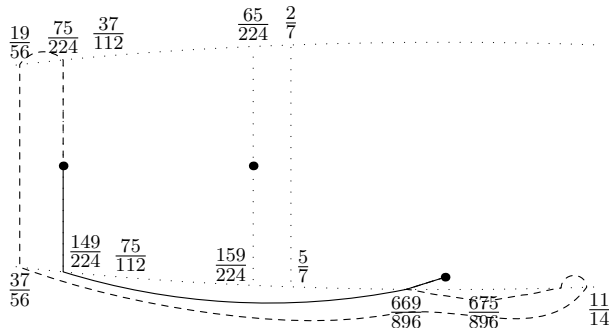

The set  $\partial'U(\beta(w_5), \beta(w_6))$ , after modification

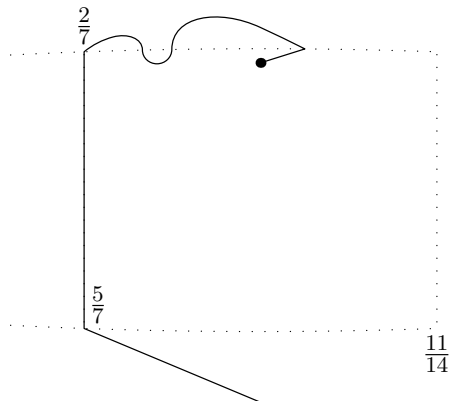

The path  $\beta'(w'_5)$ , after modification.

We also consider the intersection of  $A_{5,2/7}$  with  $U(\beta_{2/7}, \beta(w_4))$ ,  $U(\beta(w_5), \beta(w_6))$  and  $U(\beta(w_6), \beta(w_7))$ . The image of  $\partial'U(\beta(w_6), \beta(w_7))$  under  $\xi_{5,2/7}$  is then as shown.

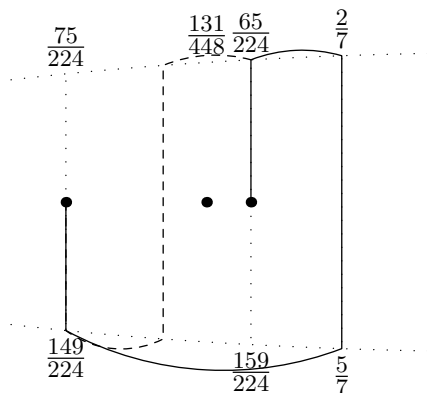

Taking into consideration all these intersections, the images under  $\xi_{5,2/7}$  of (modified)  $\partial'U(\beta_{2/7}, \beta(w_4))$ , (modified)  $\partial'U(\beta(w_5), \beta(w_6))$ , and  $\partial'U(\beta(w_6), \beta(w_7))$ , the sets bounded by these and  $\overline{\beta_{2/7} * \beta(w_4)}$  and  $\overline{\beta(w_5) * \beta(w_6)}$  and  $\overline{\beta(w_6) * \beta(w_7)}$  subdivide into sets  $U(\beta_1, \beta_2)$  for adjacent pairs  $(\beta_1, \beta_2)$  from  $R_{6,0}$ . The order of paths  $\beta(w) \in R_{6,0}$  is with  $w$  as follows:

$$\begin{aligned}
 &C, w_{11} = BCL_1R_2BCL_1R_1R_2C, w_{12} = BCL_1R_2UCL_1R_1R_2C, \\
 &w_4 = BCL_1R_2R_3L_2C, w_1 = BCL_1R_1R_2C, \\
 &w_2 = BCL_1R_1^2R_2C, w_5 = BCL_1R_1^3R_2C, \\
 &w_{10} = BCL_1R_1^4R_2C, w_{18} = BCL_1R_2R_3L_3L_2C, \\
 (7.4.10) \quad &w_{14} = L_3^2L_2BCL_1R_1R_2C, w_6 = L_3^4L_2C, \\
 &w_{17} = L_3L_2R_3L_3^2L_2C, w_7 = L_3L_2R_3L_3L_2C, \\
 &w_3 = L_3L_2R_3L_2C, w_{16} = L_3(L_2R_3)^2L_2C, \\
 &w_{13} = L_3L_2UCL_1R_1^2R_2C, w_8 = L_3L_2UCL_1R_1R_2C, \\
 &L_3L_2C, w_9 = L_3L_2BCL_1R_1R_2C, w_{20} = L_3L_2BCL_1R_1^2R_2C.
 \end{aligned}$$

For example, we have the following.

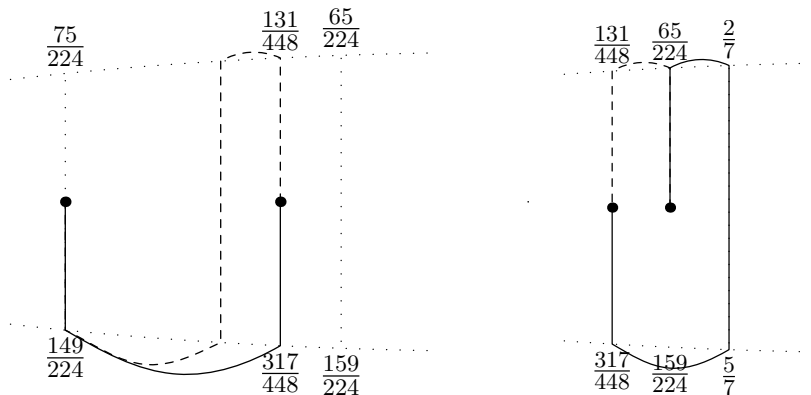

$$U(\beta(w_6), \beta(w_{17})) \text{ and } U(\beta(w_{17}), \beta(w_7)).$$

Now, without considering  $R_6(a_1, +)$  any further, we consider  $R_7(a_1, +)$ . For preperiod 7 there are 24 words in all corresponding to points in  $\cup_p U^p$ , with 12 ending in  $L_2C$  and 12 ending in  $R_1R_2C$ . However note that for  $w_{22} = L_3(L_2R_3^2L_3L_2C)$ ,  $D(w_{22})$  is contained in both  $U^0$  and  $U^1$ . We therefore expect a path in both  $R_{7,0}$  and  $R_{7,1}$  with endpoint in  $D(w_{22})$ . We shall write  $\beta(w_{22}, 0)$  and  $\beta(w_{22}, 1)$  for these paths.

First, for  $\beta(w_{22}, 0)$ , we consider the adjacent pair  $(\beta(w_{17}), \beta(w_6))$  in  $R_{6,0}$ . We consider  $\partial'U(\beta(w_{17}), \beta(w_6))$ . On this set, if  $\psi_7$  is the homeomorphism effecting the matching, we have  $\psi_7 = \psi_{7,2/7} = \xi_{6,2/7} \circ \psi_6$ . The only part of the support of  $\xi_{6,2/7}$  which intersects  $\partial'U(\beta(w_{17}), \beta(w_6))$  is  $A_{6,2/7}$ , with intersection occurring on the piece of track

$$BCL_1R_2R_3L_3^2 \rightarrow L_3(L_2R_3)^2L_3,$$

and the image of  $\partial'U(\beta(w_{17}), \beta(w_6))$  is as shown.

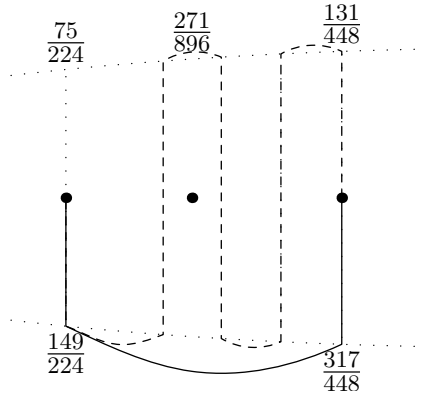

$$\xi_{6,2/7}(\partial'U(\beta(w_{17}), \beta(w_6)))$$

Therefore, for  $w_{22} = L_3(L_2R_3)^2L_3L_2C$ , the path  $\beta(w_{22}, 0)$  is between  $\beta(w_6)$  and  $\beta(w_{17})$ . Since the region bounded by  $\beta(w_1) * \beta(w_6)$  and  $\xi_{6,27}(\partial'U(\beta(w_{17}), \beta(w_6)))$  has two essential components of intersection with  $\{z : |z| < 1\}$ , up to isotopy preserving  $Z_n$  for any  $n$ , it is relatively easy to divide this region up into  $U(\beta(w_{17}), \beta(w_{22}, 0))$  and  $U(\beta(w_{22}, 0), \beta(w_6))$ .

The path  $\beta(w_{22}, 1)$  is involved in the first example of a set  $\partial'U(\beta_1, \beta_2)$  such that

$$\xi_n(\partial'U(\beta_1, \beta_2)) \neq \xi_{n,2/7}(\partial'U(\beta_1, \beta_2)) \text{ in } \pi_1(\overline{\mathbb{C}} \setminus Z_{n+1}, Z_{n+1}, Z_{n+1}),$$

with  $n = 6$ , and  $\beta_1 = \beta(w_9)$ ,  $\beta_2 = \beta(w_{19})$ . These two paths are adjacent in  $R_{6,1}$ . Here,

$$\xi_6(\partial'U(\beta_1, \beta_2)) = \xi_{6,9/28}(\partial'U(\beta_1, \beta_2)) = \xi'_{6,9/28}(\partial'U(\beta_1, \beta_2)) \text{ in } \pi_1(\overline{\mathbb{C}} \setminus Z_7, Z_7, Z_7).$$

The region bounded by  $\overline{\beta_1} * \beta_2$  and  $\xi_6(\partial'U(\beta_1, \beta_2))$  is as shown, with the points of  $Z_7$  inside the region marked.

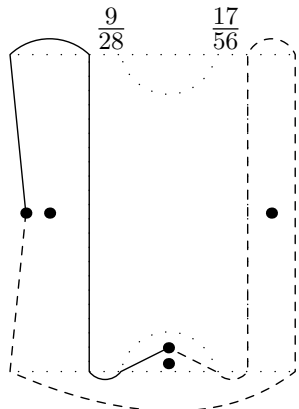

Image under  $\xi'_{6,9/28}$

This means that in  $R_{7,1}$  we want to insert another three paths between  $\beta(w_{19})$  and  $\beta(w_9)$ : a path  $\beta(w_{24})$  with endpoint in  $D(w_{24})$ , where  $w_{24} = L_3^3 L_2 R_3 L_3 L_2 C$ , a path  $\beta(w_{23})$  with  $w_{23} = L_3 L_2 B C L_1 R_1^3 R_2 C$ , and a path  $\beta(w_{22}, 1)$  with three  $S^1$ -crossings, a disc crossing from at  $e^{2\pi i(9/28)}$  to  $e^{2\pi i(19/28)}$ , and then a crossing into  $D(w_{22})$ , at the lower right-most boundary point. The other path with the same endpoint,  $\beta(w_{22}, 0)$ , is between  $\beta(w_6)$  and  $\beta(w_{17})$ . Note that this is different from the picture in  $R_{4,0}$ , of the paths between  $\beta(w_2)$  and  $\beta(w_3)$ , although there is some resemblance. The paths  $\beta(w_{23})$  and  $\beta(w_{24})$  are analogues of  $\beta(w_5)$  and  $\beta(w_7)$  and indeed are images of these paths under a local inverse of  $s^2$ , up to homotopy preserving  $Y_6$ . But  $\beta(w_6)$  and  $\beta(w_{22}, 1)$  are not related in this way, even though  $\beta(w_{22}, 1)$  is between  $\beta(w_{23})$  and  $\beta(w_{24})$  in the ordering, while  $\beta(w_6)$  is between  $\beta(w_5)$  and  $\beta(w_7)$  in the ordering.

Another example occurs for  $n = 7$ . For this one it is convenient to modify some paths in  $R'_{7,1}$  as elements of  $\pi_1(\overline{\mathbb{C}} \setminus Z_8, Z_8, v_2)$ , so that, for  $\beta_1 = \beta(w_9)$  and  $\beta_2 = \beta(w_{22}, 1)$  as elements of  $\pi_1(\overline{\mathbb{C}} \setminus Z_8, Z_8, v_2)$ , there is a kink in  $\partial'U(\beta_1, \beta_2)$  much like that in  $\partial'U(\beta(w_5), \beta(w_6))$ , effected by changing the definition of paths in  $R'_{5,0}$  as elements of  $\pi_1(\overline{\mathbb{C}} \setminus Z_6, Z_6, v_2)$ . Then

$$\xi_7(\partial'U(\beta_1, \beta_2)) \neq \xi_{7,2/7}(\partial'U(\beta_1, \beta_2)) \text{ in } \pi_1(\overline{\mathbb{C}} \setminus Z_8, Z_8, Z_8)$$

As before we have

$$\xi_7(\partial'U(\beta_1, \beta_2)) = \xi_{7,9/28}(\partial'U(\beta_1, \beta_2)) = \xi'_{7,9/28}(\partial'U(\beta_1, \beta_2)) \text{ in } \pi_1(\overline{\mathbb{C}} \setminus Z_7, Z_7, Z_7).$$

The region bounded by  $\overline{\beta_1} * \beta_2$  and  $\xi_7(\partial'U(\beta_1, \beta_2))$  is as shown, with the points of  $Z_8$  inside the region marked.

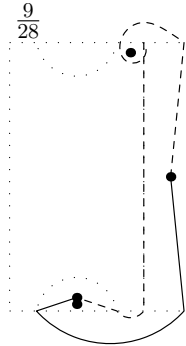

Image under  $\xi'_{7,9/28}$

We therefore define  $\beta(w_{25})$ , for  $w_{25} = L_3 L_2 U C L_1 R_2 B C L_1 R_1 R_2 C$ , to have two complete disc crossings, both in the boundary of  $D(L_3 L_2 C)$ , the first from  $e^{2\pi i(2/7)}$  to  $e^{2\pi i(5/7)}$  and the second from  $e^{2\pi i(11/14)}$  to  $e^{2\pi i(3/14)}$ , and endpoint in  $D(w_{25})$ . Note that  $D(w_{25}) \subset U_1 \setminus U^0$ , and in fact  $\beta(w_{25})$  is the unique path with its endpoint. It



is between  $\beta(w_{23})$  and  $\beta(w_{22}, 1)$ . It corresponds in some sense to the path  $\beta(w_{14}) = \beta(L_3^2 L_2 B C L_1 R_1 R_2 C)$ . But clearly it is not an inverse image of this path under  $s^2$ .

The set of paths in  $R_m(a_1, +)$ , and the ordering given on  $\cup_p R_{m,p}$  in (7.4.10), are obviously rather involved. Nevertheless, a possible strategy is emerging. The most obvious point is that the sets of paths  $R_{m,p}$  and  $R'_{m,p}$  should be obtained by induction on  $m$ . In fact, the paths of  $R_{m+1,p}$  between an adjacent pair  $(\beta_1, \beta_2)$  of  $R_{m,p}$ , and the matching paths in  $R'_{m+1,p}$  have been obtained from the set  $U(\beta_1, \beta_2)$ . This means that the definition of the paths in  $R'_{m+1,p}$  has been less direct than the definition for paths in  $R_{m+1,p}$ . Also, it will be noticed that the shape of the sets  $U(\beta_1, \beta_2)$ , and the image of the boundary subset  $\partial'U(\beta_1, \beta_2)$  under the homeomorphism  $\xi_m = \psi_{m+1} \circ \psi_m^{-1}$ , is strongly influenced by the homeomorphism  $\xi_{m,2/7}$  and its support  $A_{m,2/7} \cup C_{m,2/7}$ , in the examples so far considered.

The later examples show that it is not always true that  $\xi_m = \xi_{m,2/7}$  on  $\partial'U(\beta_1, \beta_2)$ , for adjacent pairs  $(\beta_1, \beta_2)$  in  $\cup_p R_{m,0}$ . In fact it is not even true if we restrict to  $R_{m,0}$ , although we have not yet seen any examples. But we shall obtain some control on the variation of the homeomorphisms  $\xi_m$  on sets  $\partial'U(\beta_1, \beta_2)$ . Also, in the examples so far considered, it has been true that the paths in  $R_{m,p}$  all have distinct endpoints in  $Z_m \cap U^p$ , and each point of  $Z_m \cap U^p$  has been the endpoint of exactly one path in  $R_{m,p}$ . This does not remain true for all  $m$ , although it is always true that the number of points in  $Z_m \cap U^p$  is the same as the number of paths in  $R_{m,p}$ . There is a clue in the inclusion of  $D(w_{22})$  in both  $U^0$  and  $U^1$ , and of  $D(w_{25})$  in both  $U^0$  and  $U^1$ . In a somewhat analogous way, there are two paths in  $R_{m,0}$  with endpoints in  $D(L_3 L_2 R_3 L_3 (L_2 R_3)^2 L_3 L_2 R_3 L_3 L_2 C)$ . But there are no paths with endpoint in  $D(L_3 L_2 R_3 L_3^6 L_2 R_3 L_3 L_2 C)$ .

### 7.5. Definition of $w_i(w, 0)$ and $w'_i(w, 0)$

In 2.10, we defined a set  $U^p$  for  $p \geq 0$ . Recall also from 2.10 that there is the same number of paths in  $R_{m,p}$  as of points in  $U^p \cap Z_m$ , although it is not the case that every point in  $U^p \cap Z_m$  is the endpoint of exactly one path. A point of  $U^p \cap Z_m$  is determined uniquely by a set  $D(w)$  containing it, where  $w$  is a word of length  $m + 1$  ending in  $L_2 C$ , or of length  $m + 2$  ending in  $R_1 R_2 C$ . It turns out that a path in  $R_{m,p}$  is determined by its second endpoint and its first  $S^1$ -crossing.

From now on, we consider only the case  $p = 0$ . In order to identify the path corresponding to  $w$ , we shall define a sequence  $w_i(w, 0)$  of prefixes of  $w$ , and a corresponding sequence  $w'_i(w, 0)$ , and finally, a sequence  $w'_i(w, x, 0)$  where  $x = w'_1(w, 0)$ . The sequences  $w'_i(w, 0)$  and  $w'_i(w, x, 0)$  are not, in general, sequences of prefixes of  $w$ . For some  $n$ ,  $w_n(w, 0) = w$ , and then  $w'_{i+1}(w, 0) = w'_i(w, 0)$ , and  $w'_{i+1}(w, x, 0) = w'_i(w, x, 0)$ , for  $i \geq n + 1$ .

We recall the definition of  $U^0$  from 2.10:

$$U^0 = \frac{D(L_3L_2) \cup D(BC)}{\cup \cup_{k=1}^{\infty} (D(L_3^{3k+1}L_2) \cup D(L_3^{3k-1}L_2BC)) \setminus (\cup_{k \geq 1} D(L_3L_2(UC L_1R_2)^k BC))}.$$

We define  $w_1(w, 0)$  for  $w$  with  $D(w) \subset U^0$  and with  $w$  ending in  $C$ . The definition also works for infinite words. The first letter of  $w$  is either  $BC$  or  $L_3$ . If  $BC$  is the first letter, then  $w_1(w, 0) = BC$ . If  $L_3$  is the first letter of  $w$ , and  $w$  starts with  $L_3^4$  or  $L_3^2L_2BC$ , then  $w_1(w) = L_3^4$  or  $L_3^2$  respectively. Otherwise,  $w$  starts  $L_3L_2$ , and we look for the first occurrence of one of the following. One of these must occur if  $w$  is preperiodic, that is, ends in  $C$ .

0. An occurrence of  $C$ .
1. An occurrence of  $xBC$  for any  $n \geq 0$ , where  $x$  is a maximal word in the letters  $L_3, L_2, R_3$  with an even number of  $L$  letters.
2. An occurrence of  $xUC$ , where  $x$  is a maximal word in the letters  $L_3, L_2, R_3$ , with an odd number of  $L$  letters.
3. An occurrence of  $L_1R_2UC$ .
4. An occurrence of  $R_1R_2BC$ .
5. An occurrence of a string  $v_1 \cdots v_nL_3$  which is the end of  $w$ , or is followed in  $w$  by  $L_2$ , where:
  - $v_i = L_3(L_2R_3)^{m_i}L_3^{r_i-1}$  for  $i \geq 2$ , where  $m_i + r_i = 3$ ;
  - either  $v_1 = L_3(L_2R_3)^{m_1}L_3^{r_1-1}$  for  $m_1 \geq 1$  and an odd  $m_1 + r_1 \geq 3$ , or  $v_1 = XL_1R_1^{p_1}R_2R_3(L_2R_3)^{m_1}L_3^{r_1-1}$  for  $3 \leq r_1 \leq 5$ , and  $m_1 \geq 0$ , and  $p_1 \geq 0$ , and  $X = BC$  or  $UC$ ;
  - $v_nL_3$  is either followed by  $L_2$ , or is at the end of  $w$ ;
  - the string  $v_1 \cdots v_nL_3$  is maximal with these properties;
  - $n$  is odd.

We define  $w_1(w, 0)$  to be the prefix of  $w$  ending in the occurrence listed – except in case 1 when  $n > 0$ , and in case 4 when  $w$  ends in  $L_1R_1R_2BC$ , and in case 5. In case 4, we define  $w_1(w, 0)$  to be the word up to, and not including, this occurrence of  $L_1R_1R_2BC$ , and  $w_2(w, 0)$  to be the prefix of  $w$  ending in this occurrence of  $L_1R_1R_2BC$ . In case 5, if the maximal string of words of this type is  $v_1 \cdots v_n$ , then we define  $w_1(w, 0)$  to be the prefix ending with  $v_nL_3$ .

Now suppose that the first letter of  $w$  is  $BC$ . Then  $w$  starts with  $(BCL_1R_2)^k$  for a maximal  $k \geq 0$ . Then we define  $w_2(w, 0) = w$  if there is no occurrence of cases 1 to 5 above. We define  $w_2(w, 0)$  to be the prefix of  $w$  defined exactly as  $w_1(w, 0)$  is defined when  $w$  starts with  $L_3$ , if there is an occurrence of one of 2 to 5.

It may not be immediately apparent what determines these choices. Recall that beads on  $C_{m,2/7}$  and  $A_{m,2/7}$  were defined in 7.2. In cases 1 to 4, if  $w_1 = w_1(w, 0)$  has length  $m$ , then  $D(w_1)$  is a bead on  $C_{m,2/7}$ , and in case 5 it is a bead on  $A_{m,2/7} \cap \{z :$

$|z| \leq 1$ }. Roughly half the number of beads of  $A_{m,2/7}$  and  $C_{m,2/7}$  in  $U^0$  are listed. If a bead is listed, then the adjacent bead on  $A_{m,2/7}$  or  $C_{m,2/7}$  is not listed. If a bead in  $U^0$  is not listed, then any adjacent beads which are also in  $U^0$  are listed.

The reason for the rather convoluted additional conditions in 5 is basically that, without them, the order of paths will become extremely complicated. The examples in 7.3 did not get up to high enough preperiod to illustrate the problem, which first appears at preperiod 11. But it is similar to modifications which were made in 7.3 to place  $\beta(w_{14})$  between  $\beta(w_5)$  and  $\beta(w_6)$ , rather than between  $\beta(C)$  and  $\beta(w_5)$ .

Now we define  $w'_1(w, 0) = w'_1(w_1, 0)$ . If  $w = C$  or if  $w_1$  starts with  $BC$  or  $L_3^2$ , then we define  $w'_1(w, 0) = L_3$ . Now suppose that  $w$  starts with  $L_3L_2$ , and we assume that one of cases 0 to 5 holds, which, as pointed out, is always true if  $w$  ends in  $C$ .

0.  $w'_1$  is the same length as  $w_1$ , ending in  $L_3$ , if preceded by a maximal subword in the letters  $L_3, L_2$  or  $R_3$  and with an even number of  $L$  letters, or ending in  $R_3$  if preceded by a maximal subword in the letters  $L_3, L_2$  or  $R_3$  and with an even number of  $L$  letters, such that  $D(w'_1)$  and  $D(w_1)$  are adjacent.
1. Let  $w''_1$  be obtained from  $w_1$  by deleting the last  $(UC L_1 R_2)^n BC$ , and adding  $C$ . Then  $w'_1$  is the same length as  $w''_1$ , ending in  $L_3$ , such that  $D(w'_1)$  and  $D(w''_1)$  are adjacent. If  $n > 0$  then,  $w'_2$  is the same length as  $w''_1$ , ending in  $R_3$ , such that  $D(w'_2)$  and  $D(w''_1)$  are adjacent.
2. Let  $w''_1$  be obtained from  $w_1$  by deleting the last  $UC$  and adding  $C$ . Then  $w'_1$  is defined similarly to 1, but ending in  $R_3$ .
3.  $w'_1$  is obtained from  $w_1$  by replacing the last letter by  $BC$ .
4. If  $w_1$  ends in  $R_1^2 R_2 BC$ , then  $w'_1$  is obtained from  $w_1$  by replacing the last letter by  $R_3 L_2 R_3 L_3$ . If  $w_1$  is extended in  $w$  by  $L_1 R_1 R_2 BC$ , then  $w'_1(w, 0)$  is the word of the same length as  $w_1$ , with  $D(w'_1)$  to the left of  $D(v')$ , where  $v'$  is obtained from  $w_1$  by replacing the last letter by  $C$ . We then also define  $w'_2(w, 0) = v''$ , where  $v''$  is of the same length as  $v'$ , with  $D(v')$  between  $D(w'_1)$  and  $D(v'') = D(w'_2)$ .
5. The word  $w'_1$  is obtained from  $w_1$  by deleting all but the first letter of  $v_n L_3$  if  $n > 1$ , or if  $n = 1$ ,  $m_1 + r_1 = 3$  and the first letter of  $v_1$  is  $L_3$ . In the other cases with  $n = 1$ , the word  $w'_1$  is obtained from  $w_1$  by replacing the last  $L_3^3$  by  $L_2 R_3 L_3$  if  $r_1 \geq 3$ , by deleting the last  $L_2 R_3 L_3^2$  if  $r_1 = 2$ , and by deleting the last  $(L_2 R_3)^2 L_3$  if  $r_1 = 1$ .

In many of these cases, there is a connection between  $w'_1$  and the bead  $D(w_1)$  on  $A_{n,2/7}$  or  $C_{n,2/7}$ . In parts of cases 1, 2, and 4,  $D(w'_1)$  is adjacent to the string on  $C_{n,2/7}$  between the bead preceding  $D(w_1)$ , which is mapped to  $D(w_1)$  by  $\xi_{n,2/7}$ , and the bead  $D(w_1)$  itself. In the other part of case 4,  $D(w'_1)$  is adjacent to an earlier piece of string on the same component of  $C_{n,2/7}$ . In case 3,  $D(w'_1)$  is the bead preceding

$D(w_1)$  on  $C_{n,2/7}$  and is mapped to it by  $\xi_{n,2/7}$ . In case 5,  $D(w'_1)$  contains the bead on  $A_{n,2/7}$  which is mapped by  $\xi_{n,2/7}$  to  $D(w_1)$ .

Now we define  $w_{i+1}(w, 0)$  if  $w_i = w_i(w, 0)$  has been defined. If  $w_i(w, 0) = w$  then  $w_{i+1}(w, 0) = w$ . Now suppose that  $w_i \neq w$ . Write  $w = w_i v_i$ . If  $w_i$  ends with  $L_3$ , then

$$w_{i+1} = w_i v'_i, \text{ where } L_3 v'_i = w_1(L_3 v_i, 0).$$

If  $w_i$  ends with  $BC$  or  $UC$  then

$$w_{i+1} = w_i v'_i, \text{ where } BC v'_i = w_2(BC v_i, 0).$$

We refer to *cases 1 to 5 of  $w_{i+1}$* , if  $L_3 v_i$  or  $BC v_i$  is as in case 1 to 5 for the definition of  $w_1(L_3 v_i)$  or  $w_2(BC v_i)$ .

Once again, if  $w_i$  has length  $n$ , then  $D(w_i)$  is a bead on  $A_{n,2/7}$  or  $C_{n,2/7}$ . Note that the length of  $w_i(w, 0)$  is strictly increasing with  $i$  until  $w_i(w, 0) = w$ .

We define  $w'_i$  from  $w_i$  in exactly the same way as  $w'_1$  is defined from  $w_1$ , in each of cases 0 to 5. Once again, there is a connection between  $w'_i$  and the bead and piece of string preceding the bead  $D(w_i)$  on  $A_{n,2/7}$  or  $C_{n,2/7}$ .

## 7.6. Definition of $U^x$ and $w_i(w, x, 0)$ and $w'_i(w, x, 0)$

Let  $W_1(0)$  be the set of words of the form  $w'_1(w, 0)$ , and all words of the form  $w'_2(w, 0)$  for  $w$  starting with  $BC$ . So any word in  $W_1(0)$  ends in either  $L_3$  or  $R_3$ .

It seems best not to go into too much detail at this stage, but the definitions in this section are related to a sequence of homeomorphisms  $\xi_n$  related to  $x$ , in much the same way as the definitions of  $w_i(w, 0)$  and  $w'_i(w, 0)$  in 7.5 were related to the family of homeomorphisms  $\xi_{n,2/7}$ . Many of the definitions are the same, simply because the homeomorphism  $\xi_n$  is reasonably close to  $\xi_{n,2/7}$ .

We put an ordering on the words of  $W_1(0)$  which start with  $L_3$ , using the anti-clockwise ordering on the upper half of the unit circle. If  $w$  is any finite word ending in  $L_3$  or  $R_3$ , we define  $\bar{w} = w(L_2 R_3 L_3)^\infty$ . Then  $\bar{w}$  labels a leaf  $\ell(w)$  of  $L_3/7$ , which is in the boundary of a unique gap  $G(w)$ . If  $w$  contains no letter  $BC$  or  $UC$ , then  $\ell(w)$  is a vertical leaf. If  $w \in W_1(0)$  starts with  $L_3$ , then  $\ell(w)$  has at least one endpoint on the upper half unit circle. For such  $w$ , we define  $P(w)$  to be the right-most point of  $\ell(w)$  on the upper half unit circle. Then we define  $w < w'$  if  $P(w)$  is to the right of  $P(w')$ . This means that either all of  $\ell(w)$  is to the right of  $\ell(w')$ , or the disc  $D(w)$ , which is bounded by  $\ell(w)$ , contains  $D(w')$ .

Now we define  $U^x$  for  $x \in W_1(0)$ . If  $x = L_3$ , then  $U^x$  is the union of all  $D(w)$  with  $w'_1(w, 0) = L_3$ , where the union is taken over all words not ending in  $L_3$ . Now suppose that the word  $x$  starts with  $L_3$  and that there is more than one word  $w$  with  $w_1(w, 0) = x$ . Then there are just two possibilities.

- If  $x$  ends in  $L_3(L_2R_3)^{2j}L_3^2$  for some  $j \geq 0$ , then we define  $x_1$  by replacing this by  $L_3(L_2R_3)^{2j+1}$
- If  $x$  ends in  $L_3(L_2R_3)^{2j}$  for some  $j \geq 1$ , then we define  $x_1$  by replacing this by  $L_3(L_2R_3)^{2j-1}L_3^2$ .

Then  $U^x$  is the union of all  $D(w)$  for which  $w$  satisfies  $w'_1(w, 0) = x$ , except for those of the form  $xL_3^3L_2v$  or  $x(L_2R_3)^2L_3L_2v$  or  $xL_2R_3L_3^2L_2R_3L_3L_2v$  with  $L_3L_2v \leq x$ . In these cases:

- $D(xL_3^3L_2v)$  is replaced in  $U^x$  by  $D(x_1L_2R_3L_3L_2v)$ ;
- $D(x(L_2R_3)^2L_3L_2v)$  is replaced in  $U^x$  by  $D(xL_3^3L_2v)$ .
- $D(x(L_2R_3L_3^2L_2R_3L_3L_2v))$  is replaced in  $U^x$  by  $D(x(L_2R_3)^2L_3^3L_2v)$ .

Note that the number of words extending  $xL_3^3L_2$  and ending in  $L_2C$  or  $R_1R_2C$ , of any fixed length, is the same as the number of words of the same type extending  $x_1L_2R_3L_3L_2$ . A similar statement holds for  $x(L_2R_3)^2L_3L_2$  and  $xL_3^5L_2$ , and for  $xL_2R_3L_3^2L_2R_3L_3L_2$  and  $x(L_2R_3)^2L_3^3L_2$ . Therefore, the number of words  $w$  of preperiod  $m$  with  $D(w) \subset U^x$  is the same as the number of words of preperiod  $m$  with  $w'_1(w, 0) = x$ .

Note also that for  $x$  and  $x_1$  as above,

$$\begin{aligned} w_1(xL_3^3L_2, 0) &= xL_3^3 \text{ and } w_1(x_1L_2R_3L_3L_2) = x_1L_2R_3L_3, \\ w_1(x(L_2R_3)^2L_3L_2, 0) &= x(L_2R_3)^2L_3 \text{ and } w_1(xL_3^5L_2) = xL_3^5, \\ w_1(xL_2R_3L_3^2L_2R_3L_3L_2, 0) &= xL_2R_3L_3^2, \quad w_1(x(L_2R_3)^2L_3^3L_2) = x(L_2R_3)^2L_3^3. \end{aligned}$$

Now suppose that  $x = w'_2(w, 0)$ , for at least one  $w$  starting with  $BC$ . Then  $U^x$  is the union of all  $D(w)$  with  $w'_2(w, 0) = x$ . In this case,  $w_i(w, x, 0) = w_i(w, 0)$  and  $w'_i(w, x, 0) = w'_i(w, 0)$  for all  $w$  with  $D(w) \subset U^x$ .

Now suppose that  $x$  starts with  $L_3$ . We define  $w'_1(w, x, 0) = x$  for all  $w$  with  $D(w) \subset U^x$ . So, in most, but not all, cases,  $w'_1(w, x, 0) = w'_1(w, 0)$ . We always define  $w_i(w, x, 0) = w_i(w, 0)$ . Now we define  $w'_i(w, x, 0)$  for all  $D(w) \subset U^x$  and all  $i \geq 2$ . In most cases,  $w'_i(w, x, 0) = w'_i(w, 0)$ .

The exceptions are when  $w$  has a prefix  $yL_2$  or  $y_1L_2$  with  $w_i(yL_2) = y$  or  $w_i(y_1L_2) = y_1$  and

$$\begin{aligned} (y, y_1) &= (uxL_3^3, ux_1L_2R_3L_3L_2) \text{ or } (uxL_3^5, ux(L_2R_3)^2L_3) \\ &\text{ or } w_1(ux(L_2R_3)^2L_3^3L_2), ux(L_2R_3)^2L_3^3). \end{aligned}$$

In all these cases,  $w_{i-1}(yL_2) = w_{i-1}(y_1L_2)$  and — as is easily checked —  $w_i(yL_2) = y$  if and only if  $w_i(y_1L_2) = y_1$ . We then define

$$w'_i(w, x, 0) = y_1 \text{ or } y,$$

depending on whether  $yL_2$  or  $y_1L_2$  is a prefix of  $w$ .

### 7.7. Properties with prefixes

The definition of the sequence  $w_j(w, 0)$ , and of the other sequences, is obviously rather involved. But a general principle which seems to hold is that definitions depend only on certain suffixes of  $w$ , although the length of these suffixes might be rather long. The most immediate properties are the following.

If  $i > 1$ , then  $w_{i-1}(w, 0)$  is a prefix of  $w'_i(w, 0)$ . Also,

$$w'_j(w'_i(w, 0)) = w'_j(w, 0) \text{ for } j \leq i,$$

$$w_j(w'_i(w, 0)) = w_j(w, 0) \text{ for } j < i.$$

Suppose that  $w = uv$  where the following hold:

- $D(w) \subset U^0$  and  $D(v) \subset U^0$ ;
- $w_i(w, 0)$  is a prefix of  $u$ , possibly equal to  $u$ , and  $w_{i+1}(w, 0)$  is not a prefix of  $u$  (and not equal to  $u$ );
- The word  $v$  does not start in the middle of a word  $v_1 \cdots v_n L_3$  as in 5 of the definition of  $w_1(\cdot, 0)$  of 7.5.

Then the following hold:

$$(7.7.1) \quad w_j(w, 0) = uw_{j-i}(v, 0) \text{ for } j > i;$$

$$(7.7.2) \quad w'_j(w, 0) = ww'_{j-i}(v, 0) \text{ for } j > i.$$

If  $w'_1(w, 0) = w'_1(v, 0) = x$ , then we have

$$(7.7.3) \quad w'_j(w, x, 0) = ww'_{j-i}(v, x, 0) \text{ for } j > i.$$

Now suppose that  $w'_1(w, 0) = x = x_0 L_3$ , still with  $w = uv$  as above. Suppose in addition that  $v$  contains no subword  $y$  such that

$$D(y) \subset ((U^x \setminus x_0 U^0) \cup (x_0 U^0 \setminus U^x)).$$

Then

$$(7.7.4) \quad w'_j(w, x, 0) = ww'_{j-i}(v, 0) \text{ for } j > i.$$

If  $v$  starts with  $UC$ , then we have somewhat similar statements to these. Let  $v'$  be obtained from  $v$  by replacing the first letter by  $BC$ , and simply define  $w_{j-i}(v, 0)$  and  $w'_{j-i}(v, 0)$  to be obtained from  $w_{j-i}(v', 0)$  and  $w'_{j-i}(v', 0)$  by replacing the first letter by  $UC$ . Then the statements as above hold, except that we should replace  $j - i$  by  $j - i + 1$ .

In a slightly different vein, we have the following properties as regards inserting or deleting strings  $R_1^n$ . Suppose that  $w = u_1 R_1^n v_1$  for  $n \geq 1$ , and  $w_j(w, 0) = u_1 R_1^n v_2$ . Then, for any  $m \geq 1$ ,

$$w_j(u_1 R_1^m v_1, 0) = u_1 R_1^m v_2.$$

Similar properties hold for  $w'_j(w, 0)$  and  $w'_j(u_1 R_1^m v_1, 0)$ , and also for  $w'_j(w, x, 0)$  and  $w'_j(u_1 R_1^m v_1, 0)$ , if  $x = w'_1(w, 0)$  is a prefix of  $u_1$ .

### 7.8. Definition of the paths $\beta(w, x, 0)$

Now we define a path  $\beta(w, x, 0)$  for each word  $w$  ending in  $C$  with  $w'_1(w, 0) = x$  — that is, with  $D(w) \subset U^x$  — and each  $x \in W_1(0)$ . The set  $R_{m,0}$  is then the set of all such paths for  $x \in W_1(0)$  and  $w$  ending in  $L_2 C$  of length  $m + 1$ , or in  $R_2 C$  of length  $m + 2$ . So fix  $x$ , and  $w$  with  $D(w) \subset U^x$ . We use the sequence  $w'_i(w, x, 0)$  of 7.6. Let  $n$  be the least integer with  $w'_n(w, x, 0) = w'_{n+1}(w, x, 0)$ . For  $i \leq n$ , the word  $w'_i(w, x, 0)$  determines the  $i$ 'th crossing by  $\beta$  of  $\{z : |z| \leq 1\}$ . The word  $w'_n(w, x, 0)$  determines the last  $S^1$ -crossing of  $\beta(w, x, 0)$ .

Recall that the last letter of  $w'_i$  is either  $L_3$  or  $R_3$  or  $BC$ , where the last possibility only occurs in case 3 of 7.5. First suppose that the last letter of  $w_i$  is  $L_3$  or  $R_3$ . As in 7.6, let  $\ell(w'_i)$  be the unique leaf labelled by the word  $w'_i(L_2 R_3 L_3)^\infty$ . This leaf is in the boundary of a unique gap of  $L_{3/7}$ , which we call  $G(w'_i)$ . The  $i$ 'th crossing by  $\beta(w, x, 0)$  of the unit disc is along  $\ell(w'_i)$ , directed in an anticlockwise direction along the boundary of  $G(w'_i)$ . The definition of  $\ell(w'_i)$  is made so that, if  $\ell(w'_i)$  is a vertical leaf, then it is on the left of  $G(w'_i)$  if  $i$  is odd, and on the right if  $i$  is even, so that an anticlockwise direction around  $G(w'_i)$  is always possible. If  $i = n$ , then we do not have a complete crossing of the disc, but just travel halfway along  $\ell(w'_n)$  before entering  $G(w'_n)$ , and ending at  $G(w'_n) \cap Z_m(s)$ .

Now suppose that the last letter of  $w'_i$  is  $BC$ . Let  $u'$  be the word obtained from  $w'_i$  by replacing the last letter by  $UC$ . Then  $i > 1$ , and  $u'$  and  $w'_i$  both have  $w'_{i-1}$  as a prefix, while  $u'$  is a prefix of  $w'_j$  for  $i < j \leq n$ . The words  $u'$  and  $w'_i$  then label disjoint subsets  $\partial D(w_i)$  and  $\partial D(w'_i)$  of  $\{z : |z| \leq 1\}$ . The  $i$ 'th crossing by  $\beta(w, x, 0)$  of  $\{z : |z| \leq 1\}$  is then from the first point of  $\partial D(w'_i)$  to the first point of  $\partial D(u')$ , using anticlockwise order on these intervals.

If  $w_i = w_i(w, 0)$  ends in  $L_3$  and there is no  $BC$  or  $UC$  strictly between  $w_i$  and  $w_{i+1}$ , then there is also no  $BC$  or  $UC$  strictly between  $w'_i$  and  $w'_{i+1}$ , and  $w'_i$  is a prefix of  $w$  and of  $w'_{i+1}$ , all letters strictly between  $w'_i$  and  $w'_{i+1}$  are  $L_2$ ,  $L_3$  or  $R_3$ , and the number of  $L_i$  is even or odd, depending on whether  $w'_{i+1}$  ends in  $L_3$  or  $R_3$ . Then the distance along  $S^1$  between the end of the  $i$ 'th unit-disc-crossing of  $\beta(w)$  (determined by  $w'_i$ ) and the start of  $i + 1$ 'st crossing (determined by  $w'_{i+1}$ ) is shorter than the distance between the ends of the  $i$ 'th and  $i + 1$ 'st disc crossings. This is not always true if  $w_i$  ends in  $BC$  or  $UC$ . If  $w$  starts with  $w_i L_1 R_1^2 R_2 R_3 L_3 L_2$ , then the distance along  $S^1$  between the end of the  $i$ 'th disc-crossing of  $\beta(w, x, 0)$  and the start of  $i + 1$ 'st crossing is longer than the distance between the ends of the two crossings.

The first  $S^1$  crossing of any path  $\beta \in R_{m,0}$ , for any  $m$ , is always between  $e^{2\pi i(2/7)}$  and  $e^{2\pi i(9/28)}$ , because if  $w_1(w)$  ends in  $BC$  or  $UC$ , the set  $D(w'_1(w))$  is in the part of the disc bounded by leaves with these endpoints, and if  $w_1(w)$  has no occurrence of  $BC$  or  $UC$  then  $w'_1(w)$  has an even or odd number of  $L_i$ , depending on whether it ends in  $L_3$  or  $R_3$ .

We saw in 7.6 that the number of  $w$  of preperiod  $m$  with  $w'_1(w, 0) = x$  coincides with the number of  $w$  of preperiod  $m$  with  $D(w) \subset U^x$ . The function  $w'_1(w, 0)$  is defined for all finite words  $w$  with  $D(w) \subset U^0$ . Therefore, the number of paths in  $R_{m,0}$  coincides with the number of points in  $U^0$ . We claim, but do not prove, that the number of paths in  $R_{m,p}$  coincides with the number of points in  $U^p \cap Z_m$ . In fact, we have not even defined the set of paths  $R_{m,p}$ , since  $w_i(w, p)$ ,  $w'_i(w, p)$  and  $w'_i(w, x, p)$  have not been defined for  $D(x) \subset U^p$ . But assuming that this is true, this is consistent with the counts made in 3.5.

For any path  $\beta \in \cup_m R_{m,0}$ , we write  $w(\beta)$  for the word ending in  $C$  encoding the second endpoint of  $\beta$ , and  $w'_1(\beta)$  for the word ending in  $L_3$  or  $BC$  encoding the first  $S^1$ -crossing of  $\beta$ . We also write  $w'_i(\beta)$  for the word encoding the  $i$ 'th  $S^1$ -crossing. Thus, for  $\beta \in \cup_m R_{m,0}$ ,

$$w'_i(\beta) = w'_i(w(\beta), w'_1(\beta), 0).$$

We also define

$$w_i(\beta) = w_i(w(\beta), 0).$$

### 7.9. Path-crossings and adjacency: preservation under inverse images

We obtain some information about preservation of path segments and of adjacency of paths under inverse images of  $s^n$  from 7.7. A word  $u$  describes a local inverse by

$$SD(v) = D(uv)$$

whenever  $uv$  is admissible. We fix a domain of  $u$  which is contained in either  $D(BC)$  or  $D(L_3)$ , and such that the domain does not include any  $D(v)$  such that the end of  $u$  starts earlier than the last two letters of a word as in 5 of 7.5.

For a local inverse  $S$  determined by  $u$  satisfying the conditions of (7.7.3), or with domain restricted to satisfy the conditions of (7.7.4), the identities of 7.7, and the definitions of paths in this section, imply the following. If  $\beta_1$  and  $\beta_2$  are adjacent paths in  $R_{m,0}$  with  $\overline{\beta_1} * \beta_2$  in the domain of  $S$ , then

$$(7.9.1) \quad S(\overline{\beta_1} * \beta_2) = \overline{\beta_3} * \beta_4$$



up to homotopy, where  $(\beta_3, \beta_4)$  is an adjacent pair in  $R_{m,0}$ . Conversely, if  $(\beta_3, \beta_4)$  is an adjacent pair in  $R_{m,0}$  in the image of such a local inverse  $S$ , then there is an adjacent pair  $(\beta_1, \beta_2)$  in  $R_{m,0}$  such that (7.9.1) holds.

From the definitions in this section, and the identities in 7.7, (7.9.1) holds for some other local homeomorphisms  $S$  of the form

$$S_1 S_2 s^n$$

It holds if  $S_1$  is of length  $n - 1$  determined by the letter  $UC$ , and  $S_2$  is the local inverse of  $s$  defined by the letter  $UC$ , and the domain of  $s^n$  is the image of  $S_1 S_3$ , where  $S_3$  is the local inverse of  $s$  defined by the letter  $BC$ .

It also holds if  $S_1$  is a local inverse of  $s^n$  and  $S_2$  is a local inverse of  $s^t$  determined by  $R_1^t$  for some  $t \geq 2$ , and the domain of  $s^n$  is taken to be  $\text{Im}(S_1)$ .

### 7.10. Notes on the definition of paths in $R_{m,p}$ for $p > 0$

The definition of paths in  $R_{m,p}$  for  $p > 0$  follows the same lines as the definition of paths in  $R_{m,0}$ . For words  $w$  with  $D(w) \subset U^p$ , we define finite sequences  $w_i(w, p)$  and  $w'_i(w, p)$ , and then  $w'_i(w, x, p)$ , for  $x = w'_1(w, p)$ . The definitions are suggested by the structure of the set  $U^p$  and the sets  $A_{m,q_p}$  and  $C_{m,q_p}$ , just as the definitions in the case  $p = 0$  are suggested by the structure of  $U^0$  and  $A_{m,2/7}$  and  $C_{m,2/7}$ . If  $w$  does not start with  $L_3^{2p+1} L_2$ , then we define  $w_1(w, p) = L_3^{2p+1}$ . If  $w$  does start with  $L_3^{2p+1} L_2$ , then we look for an occurrence of prefixes of a certain form. These occurrences can be of 1 to 4 as in 7.5, or an analogue of 5 of 7.5, or an extra alternative, which we call 6. In the analogue of 5 of 7.5, the form of the words  $v_i$  is  $L_3^{2p+1} (L_2 R_3)^{m_i} L_3^{2p+r_i-1}$ , and otherwise the conditions are as before. These occurrences arise for parallel reasons to the case  $p = 0$ : strings on sets  $A_{m,q_p}$  of the form

$$\begin{aligned} L_3^{4p+5} &\rightarrow L_3^{2p-1} L_2 B C L_1 R_2 R_3 L_3^{2p+1}, \\ L_3^{2p-1} L_2 B C L_1 R_2 R_3 L_3^{2p+1} &\rightarrow L_3^{2p+1} L_2 R_3 L_3^{2p+2}, \\ L_3^{2p-1} L_2 B C L_1 R_2 R_3 L_3^{2p+2} &\rightarrow L_3^{2p+1} (L_2 R_3)^2 L_3^{2p+1}. \end{aligned}$$

The extra alternative 6 arises from the extra thickness of  $C_{2,q_p}$  in the case  $p > 0$ . We look for a first occurrence of  $x R_3 L_2 R_3 L_3^{2t-1} L_2$  or  $x L_3 L_2 R_3 L_3^{2t-1} L_2$  for  $t \leq p$ , depending on whether the longest suffix of  $x$  containing only letters  $L_3$ ,  $L_2$  and  $R_3$  has an even or odd number of  $L$  letters. There is a connection, here, with the definition of the set  $U^p$ , and the inclusion of the sets  $S_{2,p,k} D(w_t)$  in 2.10.

**7.11. Final statement in the hard and interesting case**

We can now be more precise about the structure of the path sets  $R_{m,0}$  and  $R'_{m,0}$  — and hence also of  $\Omega_{m,0}$  and  $\Omega'_{m,0}$ . So the final statement of the Main Theorem in the hard and interesting case is as follows. We have given only sketchy detail of the definition of  $R_{m,p}$ , and hence also of  $\Omega_{m,p}$ , for  $p \geq 1$ . So the detailed statement of the theorem in the case  $p \geq 1$  is not contained in this chapter, and we shall prove the detail of the theorem only in the case  $p = 0$ , that is, we shall prove that a piece of the fundamental domain can be chosen as claimed, bounded by leaves whose images under  $\rho(\cdot, s_{3/7})$  are  $\beta_{2/7}$ ,  $\beta_{5/7}$ ,  $\beta_{9/28}$  and  $\beta_{19/28}$ .

**Main Theorem (final version, hard case)**

*Recall that  $s = s_{3/7}$ . We have*

$$\Omega_m(a_1, +) = \cup_{p=0}^{\infty} \Omega_{m,p} \cup \Omega'_{m,p} \cup \{\omega_{\infty}\},$$

*where this is a disjoint union, and*

$$R_m(a_1, +) = \cup_{p=0}^{\infty} R_{m,p} \cup R'_{m,p} \cup \{\beta_{1/3}\},$$

*where*

$$R_{m,p} = \rho(\Omega_{m,p}, s), \quad R'_{m,p} = \rho(\Omega'_{m,p}, s).$$

*Any adjacent pair in  $\Omega_m(a_1, +)$  is an adjacent pair in exactly one of the sets  $\Omega_{m,p}$  or  $\Omega'_{m,p}$ . Every adjacent pair in  $\Omega_{m,p}$  is matched with one adjacent pair in  $\Omega'_{m,p}$ , and with no other. Write  $Z_{\infty} = \cup_n Z_n$ . The paths in  $R_{m,p}$  and  $R'_{m,p}$  are defined as elements of  $\pi_1(\overline{\mathbb{C}} \setminus Z_{\infty}, v_2, Z_{\infty})$ , with*

$$R_{m,p} \subset R_{m+1,p}, \text{ in } \pi_1(\overline{\mathbb{C}} \setminus Z_{\infty}, v_2, Z_{\infty}),$$

$$R'_{m,p} \subset R'_{m+1,p} \text{ in } \pi_1(\overline{\mathbb{C}} \setminus Z_m, v_2, Z_m).$$

*The sets of paths  $R_{m,p}$ ,  $R'_{n,q}$  are all disjoint, except that, if  $m > 2p + 2$ ,*

$$R_{m,p} \cap R_{m,p+1} = \{\beta_{q_{p+1}}\},$$

*and*

$$R'_{m,p} \cap R'_{m,p+1} = \{\beta_{1-q_{p+1}}\}.$$

*Also,  $\beta_{1/3} \in R_{m,p} \cap R'_{m,p}$ , for the largest  $p$  such that these are nonempty.*

*A path  $\beta$  in  $R_{m,p}$  has first  $S^1$  crossing at  $e^{2\pi ix}$  for some  $x \in [q_p, q_{p+1})$ , where  $x = w'_1(\beta) = w'_1(w(\beta), p)$  and  $e^{2\pi ix}$  is an endpoint of a leaf of  $L_{3/7}$ , and the first unit-disc crossing by  $\beta$  is along this disc. The later crossings are encoded by the words  $w'_i(w, x, p)$ . Thus, up to homotopy,  $\beta$  is a union of segments along the upper or lower half of the unit disc, leaves of  $L_3$  in  $U^p$ , some segments in gaps of  $L_{3/7}$  and a final segment in a gap of  $L_{3/7}$  ending at a point of  $U^p \cap Z_m$ . Also,  $\beta$  is determined uniquely by its first  $S^1$ -crossing and its final endpoint, but not always by its final endpoint alone.*

*Nevertheless, the paths in  $R_{m,p} \setminus \{\beta_{q_p}\}$  are in one-to-one correspondence with the points in  $Z_m \cap U^p$ .*

Because of the matching between adjacent pairs in  $\Omega_{m,p}$  and  $\Omega'_{m,p}$ , the part of the tree in  $V_{3,m}(a_1, +)$  associated to the fundamental region which has been constructed is an interval. One should not read too much into this. There is a lot of choice in construction of the fundamental domain. But this case is very different from the easy cases. It is certainly not possible to choose a fundamental domain which inherits the structure of part of  $T_m(s_{3/7})$  — except for  $m \leq 2$ , as can be seen from the computations in 7.4.

It will have noticed that  $R_{m,0}$  has been described in exhausting detail, but nothing has been said about  $R'_{m,0}$ . The set of paths  $R'_{m,0}$  will be completely described in the next chapter.



## CHAPTER 8

### PROOF OF THE HARD AND INTERESTING CASE

#### 8.1. The inductive construction

We continue with the notation established at the start of Section 7. We prove the most detailed part of the theorem only in the case  $p = 0$ , that is, for  $R_{m,0}$  and  $R'_{m,0}$ .

The path sets  $\Omega_{m,0}$  and  $\Omega'_{m,0}$  are described by the images  $R_{m,0}$  and  $R'_{m,0}$ , under  $\rho$  in the statement of the Main Theorem 7.11. An adjacent pair in  $\Omega_{m,0}$  or  $\Omega'_{m,0}$  corresponds to an adjacent pair in  $R_{m,0}$  or  $R'_{m,0}$ . Matching of an adjacent pair in  $\Omega_{m,0}$  with an adjacent pair in  $\Omega'_{m,0}$  is viewed by considering the image under  $\rho$  and  $\Phi_2$  of the element of  $\pi_1(V_{3,m}, a_1)$  effecting the matching, as described in 5.6, in particular in (5.6.3) and (5.6.4). So for each adjacent pair  $(\beta_1, \beta_2)$  in  $R_{m,0}$ , we shall choose  $\alpha_m \in \pi_1(\overline{\mathbb{C}} \setminus Z_m, v_2)$  and  $[\psi_m] \in \text{MG}(\overline{\mathbb{C}}, Y_m)$  so that

$$(8.1.1) \quad (s, Y_m) \simeq_{\psi_m} (\sigma_{\alpha_m} \circ s, Y_m),$$

and, for  $i = 1, 2$ ,

$$(8.1.2) \quad \beta_{m,i} = \alpha_m * \psi_m(\beta'_{m,i}) \text{ rel } Y_m.$$

The paths in  $R_{m,0}$  have been defined as elements of  $\pi_1(\overline{\mathbb{C}} \setminus Z_\infty, Z_\infty, v_2)$ , and, if  $m \leq n$  we have  $R_{m,0} \subset R_{n,0}$  in  $\pi_1(\overline{\mathbb{C}} \setminus Z_\infty, Z_\infty, v_2)$ . As indicated in 7.11, the paths in  $R'_{m,0}$  will be defined as elements of  $\pi_1(\overline{\mathbb{C}} \setminus Z_m, Z_m, v_2)$ , so that, if  $m \leq n$ ,

$$R'_{m,0} \subset R'_{n,0} \text{ in } \pi_1(\overline{\mathbb{C}} \setminus Z_m, Z_m, v_2).$$

The total ordering on  $R_{m,0}$  is easily seen, by fixing lifts to the universal cover, all with the same first endpoint, and using the ordering on the second endpoints. The universal cover is the unit disc up to holomorphic equivalence, and under this equivalence the lifts of the paths in  $R_{m,0}$  have endpoints in the unit circle. We take the order on the unit circle, with the endpoint of  $\beta_{2/7}$  as minimal, and  $\beta_{9/28}$  is maximal. Since the elements of  $R'_{m,0}$  are matched with the elements of  $R_{m,0}$ , they, too, are totally ordered, by the condition that matching preserves order. The minimal and maximal elements of  $R'_{m,0}$  are  $\beta_{5/7}$  and  $\beta_{19/28}$ . Similarly, the sets  $R_{m,p}$  and  $R'_{m,p}$  are totally ordered.

The minimal and maximal elements of  $R_{m,p}$  are  $\beta_{q_p}$  and  $\beta_{q_{p+1}}$ , and the minimal and maximal elements of  $R'_{m,p}$  are  $\beta_{1-q_p}$  and  $\beta_{1-q_{p+1}}$ . Since the sets  $\{\beta_{q_p} : p \geq 0\}$  and  $\{\beta_{1-q_p} : p \geq 0\}$  are also totally ordered, the sets  $\cup_{p \geq 0} R_{m,p}$  and  $\cup_{p \geq 0} R'_{m,p}$  are also totally ordered

Let  $(\beta_1, \beta_2)$  be an adjacent pair in  $R_{m,0}$ , matched with an adjacent pair  $(\beta'_1, \beta'_2)$  in  $R'_{m,0}$ . In general, we shall choose  $\alpha_m \in \pi_1(\overline{\mathbb{C}} \setminus Z_\infty, v_2)$  and  $\psi_m$  representing an element of  $\text{MG}(\overline{\mathbb{C}}, Y_\infty)$  inductively for  $m \geq 2$ . For each  $2 \leq k \leq m$ , there is an adjacent pair  $(\beta_{k,1}, \beta_{k,2})$  in  $R_{k,0}$  such that  $\beta_1$  and  $\beta_2$  are between  $\beta_{k,1}$  and  $\beta_{k,2}$ . The induction starts with  $\beta_{2,1} = \beta_{2/7}$  and  $\beta_{2,2} = \beta_{9/28}$ , and ends with  $\beta_{m,1} = \beta_1$  and  $\beta_{m,2} = \beta_2$ . Similarly, there is an adjacent pair  $(\beta'_{k,1}, \beta'_{k,2})$  in  $R'_{k,0}$  which is matched with  $(\beta_{k,1}, \beta_{k,2})$ , and such that  $\beta'_1$  and  $\beta'_2$  are between  $\beta'_{k,1}$  and  $\beta'_{k,2}$ . For intermediate  $k$ ,  $\beta_{k,1} = \beta_{m,1}$  and  $\beta_{k,2} = \beta_{m,2}$  are possible. If  $\beta_1 = \beta_{k,1}$  in  $\pi_1(\overline{\mathbb{C}} \setminus Z_k, Z_k, v_2)$  then  $\beta_1 = \beta_{k,1}$  in  $\pi_1(\overline{\mathbb{C}} \setminus Z_\infty, Z_\infty, v_2)$ . The corresponding statement is not quite true for  $\beta'_{k,1}$  and  $\beta'_1$ . It can happen that  $\beta'_1 = \beta'_{k,1}$  in  $\pi_1(\overline{\mathbb{C}} \setminus Z_k, Z_k, v_2)$  and  $\beta'_1 = \beta'_{k+1,1}$  in  $\pi_1(\overline{\mathbb{C}} \setminus Z_{k+1}, Z_{k+1}, v_2)$  but  $\beta'_{k,1} \neq \beta'_{k+1,1}$  in  $\pi_1(\overline{\mathbb{C}} \setminus Z_{k+1}, Z_{k+1}, v_2)$ . In fact this happens very often, but is not very visible, because of the indirect definition of  $R'_{m,0}$ .

For any choice of adjacent pair  $(\beta_1, \beta_2)$  in  $R_{m,0}$ , we have

$$\beta_{2,1} = \beta_{2/7}, \quad \beta_{2,2} = \beta_{9/28},$$

and, for  $0 \leq i \leq 2$ ,  $\alpha_i$  is an arbitrarily small perturbation of  $\beta_{2/7} * \overline{\beta_{5/7}}$ , and

$$\psi_i = \psi_{i,2/7},$$

for  $\psi_{i,2/7}$  as in 7.3, which is the identity on  $\beta_{5/7}$  for  $i \leq 2$ . So the loop  $\alpha_0 = \alpha_1 = \alpha_2$  bounds a disc not containing  $c_1$ . The defining equations of  $\psi_m$  and  $\alpha_m$  are

$$(8.1.3) \quad \psi_m \circ s = \sigma_{\alpha_m} \circ s \circ \psi_{m+1},$$

and  $\alpha_m$  is homotopic to an arbitrarily small perturbation of  $\beta_m * \psi_m(\overline{\beta_{m,1}})$  in  $\pi_1(\overline{\mathbb{C}} \setminus Z_m, v_2)$ . We then have

$$(8.1.4) \quad \alpha_m * \psi_{m+1}(\beta'_{m,i}) = \beta_{m,i} \text{ in } \text{MG}(\overline{\mathbb{C}} \setminus Z_m, Z_m, v_2).$$

and

$$(8.1.5) \quad (s, Y_{m+1}) \simeq_{\psi_{m+1}} (\sigma_{\alpha_m} \circ s, Y_{m+1}).$$

We also define  $[\xi_m] \in \text{MG}(\overline{\mathbb{C}}, Y_\infty)$  by

$$(8.1.6) \quad \psi_{m+1} = \xi_m \circ \psi_m.$$

An example of this inductive construction is given (for general  $p$ ) in 7.3, for the adjacent pair  $(\beta_{q_p}, \beta_{q_{p+1}})$  in  $R_{p,2p+2}$ . We saw in 7.3 that the homeomorphism  $\psi$  effecting the matching between  $(\beta_{q_p}, \beta_{q_{p+1}})$  and  $(\beta_{1-q_p}, \beta_{1-q_{p+1}})$  satisfies

$$(8.1.7) \quad \psi(\beta_{1-q_p}) = \beta_{q_p} \text{ in } \pi_1(\overline{\mathbb{C}} \setminus Z_{2p+2}, Z_{2p+2}, v_2)$$

An arbitrarily small perturbation of  $\beta_{q_p} * \psi(\beta_{1-q_p})$  is freely homotopic, in  $\overline{\mathbb{C}} \setminus Z_{2p+1}$ , to a simple closed loop which intersects the unit disc in the leaf of  $L_{3/7}$  joining the points  $e^{\pm 2\pi i(1/3)}$ .

Now we introduce another object related to the adjacent pair  $(\beta_{m,1}, \beta_{m,2})$ . We denote the set bounded by  $\overline{\beta_{m,1}} * \beta_{m,2}$  and  $\psi_m(\overline{\beta'_{m,1}} * \beta'_{m,2})$  by  $U(\beta_{m,1}, \beta_{m,2})$ . These two paths with endpoints in  $Z_m$  are then defined as elements of  $\pi_1(\overline{\mathbb{C}} \setminus Z_\infty, Z_\infty)$ . The boundary of this set is a union of two arcs: the *solid boundary*  $\overline{\beta_{m,1}} * \beta_{m,2}$  and the *dashed boundary*  $\psi_m(\overline{\beta'_{m,1}} * \beta'_{m,2})$ . We denote the set bounded by  $\overline{\beta_{m,1}} * \beta_{m,2}$  and  $\psi_{m+1}(\overline{\beta'_{m,1}} * \beta'_{m,2})$  by  $V(\beta_{m,1}, \beta_{m,2}, m+1)$ , and, once again, the boundary is the union of two arcs: the *solid boundary*  $\overline{\beta_{m,1}} * \beta_{m,2}$  and the *dashed boundary*  $\psi_{m+1}(\overline{\beta'_{m,1}} * \beta'_{m,2})$ . The definitions then give

$$\partial'V(\beta_{m,1}, \beta_{m,2}) = \psi_{m+1}(\overline{\beta'_{m,1}} * \beta'_{m,2}) = \xi_m(\partial'U(\beta_{m,1}, \beta_{m,2}))$$

We make definitions so that

$$(8.1.8) \quad \begin{aligned} U(\beta_1, \beta_2) &\text{ is a topological disc,} \\ V(\beta_1, \beta_2, m+1) &\text{ is also a disc} \end{aligned}$$

In general, for  $n \geq m$  for an adjacent pair  $(\beta_1, \beta_2)$  in  $R_{m,p}$ , we write  $V(\beta_1, \beta_2, n)$  for the union of sets  $U(\beta_3, \beta_4)$  for adjacent pairs  $(\beta_3, \beta_4)$  in  $R_{n,p}$  between  $\beta_1$  and  $\beta_2$ . We shall see that the two definitions coincide for  $n = m+1$ , up to isotopy preserving  $Z_{m+1}$ .

Then it is clear that an inductive definition of  $R_{m+1,0}$  and  $R'_{m+1,0}$  is given by defining a subdivision of the sets  $V(\beta_1, \beta_2, m+1)$  into sets  $U(\beta_3, \beta_4)$ , for all adjacent pairs  $(\beta_1, \beta_2)$  of  $R_{m,0}$ , thus defining all adjacent pairs  $(\beta_3, \beta_4)$  in  $R_{m+1,0}$ . We caution that there will be cases when the set  $V(\beta_1, \beta_2, m+1)$  is only a union of sets  $U(\beta_3, \beta_4)$  up to homotopy in  $Z_m$ . In these cases the definition of the elements  $\beta'_1, \beta'_2$  matched with  $\beta_1$  and  $\beta_2$  will be different, as elements of  $\pi_1(\overline{\mathbb{C}} \setminus Z_\infty, v_2, Z_\infty)$ , in  $R'_{m,0}$  and in  $R'_{m+1,0}$ .

In order to prove the Main Theorem 7.11, we have to prove two subsidiary theorems. We state the first theorem only in the case  $p = 0$ , and we shall only prove it only in this case. However, there is also a version in the case of  $p > 0$ .

**THEOREM 8.2.** – *The sets  $U(\beta_1, \beta_2)$  for adjacent pairs  $(\beta_1, \beta_2)$  can be defined so that the following holds. Fix any  $x \in W_1(0)$ . Let  $\beta_1 \in R_{m,0}$  be minimal with  $w'_1(\beta_1) = x$ , and  $m$  minimal with  $\beta_1 \in R_{m,0}$ . Let  $\beta_1 < \beta_{n,2}$  be adjacent in  $R_{n,0}$  for any  $n \geq m$ . Let  $\xi_{n,1}$  be the homeomorphism associated to the pair  $(\beta_1, \beta_{n,2})$ , like the sequence  $\xi_n$  in (8.1.6). Then for any adjacent pair  $(\beta_3, \beta_4)$  in  $R_{n,0}$  with  $w'_1(\beta_{n,3}) = x$  and associated*

homeomorphism  $\xi_n$  as in (8.1.6), up to  $Z_{n+1}$ -preserving isotopy, the region bounded by  $\overline{\beta_3} * \beta_4$  and  $\xi_{n,1}(\partial'U(\beta_3, \beta_4))$  is, up to isotopy preserving  $Z_{n+1}$ :

$$(8.2.1) \quad \cup \{U(\beta_5, \beta_6) : (\beta_5, \beta_6) \text{ adjacent in } R_{n+1,0}, \beta_3 \leq \beta_5 < \beta_6 \leq \beta_4\}.$$

Also,

$$(8.2.2) \quad \text{supp}(\xi_n \circ \xi_{n,1}^{-1}) \cap \xi_{n,1}(\partial'U(\beta_3, \beta_4)) = \emptyset.$$

Also, for any  $x$  of the form  $w'_2(w)$  for some  $w$  starting with  $BC$ , a similar result holds for the minimal  $\beta_1$  with  $w'_2(\beta_1) = x$  and any pair  $(\beta_3, \beta_4)$  in  $R_{n,0}$  with  $w_2(\beta_3) = x$ .

**THEOREM 8.3.** – *The paths of  $R_{m,p}$  and  $R'_{m,p}$  are in the set  $D'$  of 3.3 for all  $m \geq 1$  and all  $p \geq 0$ .*

That is, the obverse of the Inadmissibility Criterion of 3.4 holds. This will be proved in 8.12.

#### 8.4. Adjacent elements in $R_{m,0}$ : how many $S^1$ -crossings are the same?

We have seen that a path  $\beta$  in  $R_{m,0}$  is determined by a sequence

$$(x, \{w'_i(w, x, 0) : 2 \leq i \leq n\}).$$

We write  $\beta = \beta(w, x)$  if  $w$  ends in  $C$  and  $\beta$  ends at the point of  $Z_m$  encoded by this word. Because of the rules on the definitions of  $w'_1(w, 0)$ ,  $w_i(w, x, 0)$  and  $w'_i(w, x, 0)$ , the paths adjacent to  $\beta(w) \in R_{m,0}$  are determined by the end part of the word. The examples calculated in 7.4 are therefore highly indicative of the general picture. The following holds.

**Lemma** *Let  $\beta_1$  and  $\beta_2$  be adjacent in  $R_{m,0}$  with  $\beta_1 < \beta_2$ . If  $w'_1(\beta_1) \neq w'_1(\beta_2)$ , define  $i = 0$ . Otherwise, let  $i$  be such that  $w'_j(\beta_1) = w'_j(\beta_2)$  for  $j \leq i$  but  $w'_{i+1}(\beta_1) \neq w'_{i+1}(\beta_2)$ .*

**Case 1.** *Suppose that it is not the case that one of  $w_{i+1}(\beta_1)$  and  $w_{i+1}(\beta_2)$  is of the form  $vL_1R_2UC$  and the other of the form  $vL_1R_2(BC L_1R_2)y$ .*

- a) *If  $w'_i(\beta_1)$  ends in  $L_3$ , then  $w_{i+2}(\beta_1) = w(\beta_1)$  and  $w_{i+1}(\beta_2) = w(\beta_2)$ .*
- b) *If  $w'_i(\beta_1)$  ends in  $R_3$ , and  $w_{i+1}(\beta_1) \neq w(\beta_1)$ , then  $w_{i+3}(\beta_1) = w(\beta_1)$  and  $w_{i+1}(\beta_2) = w(\beta_2)$ .*

**Case 2** *Suppose that  $w_{i+1}(\beta_1)$  and  $w_{i+1}(\beta_2)$  are of the form excluded in Case 1. Then  $w_{i+1}(\beta_1) = w(\beta_1)$ ,  $w_{i+1}(\beta_2) \neq w(\beta_2)$  and  $w_{i+2}(\beta_2) = w(\beta_2)$ .*



*Proof.* – *Case 1.* We are supposing that  $w_{i+1}(\beta_2)$  is not of the form  $vL_1R_2UC$ . Then  $w'_{i+1}(\beta_2)$  ends in  $L_3$  or  $R_3$ , and there is  $z$  of the same length as  $w'_{i+1}(\beta_2)$  ending in  $C$ , with  $D(z)$  and  $D(w'_{i+1}(\beta_2))$  adjacent. Let  $\beta_3$  be the path with  $w'_{i+1}(\beta_3) = w'_{i+1}(\beta_2)$  and  $w_{i+1}(\beta_3) = z$ . Then since  $w_{i+1}(\beta_1) \neq w_{i+1}(\beta_2)$ , we have  $\beta_1 \leq \beta_3 \leq \beta_2$ , and  $\beta_3 = \beta_2$ . So  $w_{i+1}(\beta_2) = w(\beta_2)$ .

*Case 1.1:*  $w_i(\beta_1) \neq w_i(\beta_2)$ .

If  $i = 0$  and  $w_1(\beta_2) = w(\beta_2)$ , then  $w'_1(\beta_1) \neq w'_1(\beta_2)$ , and so  $\beta_1$  is maximal in  $R_{m,0}$  with  $w'_1(\beta_1) = x$  (for some  $x$ ). We return to this case shortly.

Suppose that  $i > 0$  and that  $u = w_i(\beta_1) \neq w_i(\beta_2) = u'$ . The possibilities for  $u = w_i(\beta_1)$  given  $w'_i(\beta_1)$  are given in 7.5: in all cases,  $w'_i$  is obtained from  $w_i$  either by deleting an end part of  $w_i$ , or, if  $w_i$  ends in  $C$  or  $BC$  or  $UC$ , then  $w_i$  and  $w'_i$  have the same length and the discs  $D(w_i)$  and  $D(w'_i)$  are adjacent. At any rate, the possibilities for  $w_i$  all end in  $L_3$ ,  $C$ ,  $BC$  or  $UC$ , and these are ordered in terms of the order of the sets  $D(u)$ , with  $u$  being minimal for the unique such word ending in  $C$ . If  $u$  ends in  $C$ , then  $u'$  ends in  $BC$  or  $UC$  — depending on whether  $w'_i(\beta_1) = w'_i(\beta_2)$  ends in  $L_3$  or  $R_3$  — and  $\beta_2$  must be minimal among  $\beta \in R_{m,0}$  with  $w'_i(\beta) = w'_i(\beta_1) = w'_i(\beta_2)$  and  $w(\beta)$  of the form  $u'y$ . If  $u$  ends in  $BC$  or  $UC$ , then  $\beta_1$  must be maximal among  $\beta \in R_{m,0}$  with  $w(\beta)$  of the form  $uy$  and  $w'_i(\beta) = w'_i(\beta_1)$ . We shall return to these cases shortly. If  $u = w_i(\beta_1)$  ends in  $L_3$ , for example,  $u = L_3^4$ , then  $\beta_1$  must be maximal among  $\beta \in R_{m,0}$  with  $w_i(\beta) = u$  and  $w'_i(\beta) = w'_i(\beta_1)$ . We then have  $w'_{i+1}(\beta_1) = uL_3^2$ , and  $\beta_1$  is maximal among  $\beta \in R_{m,0}$  with  $w'_{i+1}(\beta) = uL_3^2$  and  $w'_i(\beta) = w'_i(\beta_1)$ . Again, we return to this case shortly.

*Case 1.2:*  $w_i(\beta_1) = w_i(\beta_2)$ . Suppose that  $u' = w'_{i+1}(\beta_1) \neq w'_{i+1}(\beta_2) = w(\beta_2)$ . Then  $\beta_1$  is maximal among  $\beta \in R_{m,0}$  with  $w'_{i+1}(\beta) = u'$  and  $w'_i(\beta) = w'_i(\beta_1)$ . This is simply a more general version of the second maximal property of Case 1.1. We return to it below.

*Case 2.* Suppose that  $w_{i+1}(\beta_2) = vL_1R_2UC$  for some  $v$ . Then since  $w_{i+1}(\beta_1) \neq w_{i+1}(\beta_2)$ , we must have  $w(\beta_1) = v'$ , where  $v'$  is obtained by replacing the last letter of  $v$  by  $C$ , or  $w(\beta_1) = vL_1R_2BCL_1R_2BCz$  for some  $z$ , depending on the length of  $v$  in comparison with  $m$ , and  $\beta_1$  must be maximal in  $R_{m,0}$  among  $\beta$  with  $vL_1R_2BCL_1R_2BC$  as a prefix of  $w(\beta)$ . This is the same property as the first maximal property in Case 1.1.

So suppose that  $u$  ends in  $BC$  or  $UC$ . Maximal paths  $\beta \in R_{m,0}$  with  $w(\beta)$  of the form  $uy$  have  $w(\beta) = uL_1R_1^pR_2C$  for  $1 \leq p \leq 3$ , or  $uL_1R_1R_2R_3L_3L_2C$ . Minimal paths with  $w(\beta)$  of the form  $uy$  have  $w(\beta) = u(L_1R_2BC)^nL_1R_1R_2C$  for some  $n \geq 0$ .

Now we return to the other possibilities in Case 1. Words  $v$  such that  $\beta \in R_{m,0}$  is maximal with respect to the property that  $w'_{i+1}(\beta) = u$ , with  $u$  ending in  $L_3$  or  $R_3$  are, respectively,  $u''C$  of the same length as  $u$  with  $D(u''C)$  and  $D(u)$  adjacent, then, for increasing  $m$ ,  $v = u''XL_1R_1R_2C$  where  $X = BC$  or  $UC$ , depending on whether  $u$  ends

in  $L_3$  or  $R_3$ , then  $uL_3^3L_2C$ , then  $uL_2R_3L_3^2L_2C$ , then different possibilities depending on whether  $u$  ends in  $L_3$  or  $R_3$ . If  $u$  ends in  $L_3$ , then the additional possibilities, for increasing  $m$ , are of the form

$$u(L_2R_3L_3)^qL_2y,$$

$$y = BCL_1R_1R_2C \text{ or } R_3L_3^4L_2C \text{ or } R_3L_3L_2R_3L_3^2L_2C$$

for any  $q \geq 0$ . If  $u$  ends in  $R_3$  then the additional possibilities are

$$uL_2R_3L_3^2(L_2R_3L_3)^q(L_2 \text{ or } L_2R_3L_2)C$$

for any  $q \geq 0$ .

In all but the last case,  $w_{i+2}(\beta_1) = \beta_1$ , and in the last case,  $w_{i+3}(\beta_1) = \beta_1$ . So  $w_{i+2}(\beta_1) = \beta_1$  if  $w(\beta_1)$  ends in  $L_3$  and  $w_{i+3}(\beta_1) = \beta_1$  if  $w$  ends in  $R_3$ .  $\square$

### 8.5. Definition of $\xi_{m,0}$ and $\xi_{m,1}$

We define  $k_0$ , and sequences  $\psi_{m,0}$ ,  $\alpha_{m,0}$  and  $\xi_{m,0}$  associated to an adjacent pair  $(\gamma_1, \gamma_2)$  in  $R_{m,0}$ , as follows. If  $w(\gamma_1)$  starts with  $BC$ , then  $\psi_{m,0} = \psi_m$ ,  $\alpha_{m,0} = \alpha_m$  and  $\xi_{m,0} = \xi_m$ , where these are the usual sequences associated to  $(\gamma_1, \gamma_2)$ . Otherwise, let  $k_0$  be the largest index such that  $w(\beta_{k_0})$  starts with  $BC$ , where  $(\beta_k, \beta_{k,2})$  is the adjacent pair in  $R_{k,0}$  with  $\gamma_1$  and  $\gamma_2$  between  $\beta_k$  and  $\beta_{k,2}$ . Also, let  $\beta'_{k_0}$  be the element of  $R'_{k_0}$  which is matched with  $\beta_{k_0}$ . Then  $k_0 = 3t$  for some  $t \geq 1$  and  $w(\beta_{k_0}) = (BCL_1R_2)^{t-1}BCL_1R_1R_2C$ . Then we define

$$\psi_{k_0,0} = \psi_{k_0}, \quad \alpha_{k_0,0} = \alpha_{k_0}, \quad \xi_{k_0,0} = \xi_{k_0}.$$

Then for  $k \geq k_0$ , we define  $\psi_{k+1,0}$  and  $\xi_{k,0}$  inductively by

$$\sigma_{\alpha_{k,0}} \circ s \circ \psi_{k+1,0} = \psi_{k,0} \circ s.$$

and

$$\psi_{k+1,0} = \xi_{k,0} \circ \psi_{k,0},$$

and  $\alpha_{k+1,0}$  is the perturbation of  $\beta_{k_0} * \psi_{k+1,0}(\overline{\beta'_{k_0}})$  which is equal to  $\alpha_{k,0}$  in  $\pi_1(\overline{C} \setminus Z_k, v_2)$ . The support of  $\xi_{m,0}$  is relatively easy to compute directly. It can be written as

$$A_{m,2/7} \cup C_m,$$

where  $C_m$  is disjoint from  $A_{m,2/7}$ , coincides with  $C_{m,2/7}$  for  $k \leq k_0$  and only differs from  $C_{m,2/7}$  for  $m > k_0$  in preimages of the periodic component of  $C_{k_0,2/7}$ . The difference happens because components of the backward orbit of the periodic component of  $C_{k_0,2/7}$  which intersect the central gap now pull back homeomorphically, not with degree two, and pieces of string which are close to the central gap, pull back close to the preimage gap.

Similarly, we define sequences  $\psi_{m,1}$ ,  $\xi_{m,1}$  and  $\alpha_{m,1}$ , using  $\beta_{k_1}$  for some  $k_1 \geq k_0$ . If  $w'_1(\beta_1) = L_3$ , then  $k_1 = k_0$ . Otherwise,  $k_1$  is the least index such that  $w'_1(\beta_{k_1}) = w'_1(\beta_1)$ .

We shall use 8.6 to analyse  $\xi_{m,1} \circ \xi_{m,0}^{-1}$  and  $\xi_m \circ \xi_{m,1}^{-1}$ .

### 8.6. Comparing $\xi_n$ and $\xi_{n,0}$ and $\xi_{n,1}$

To prove 8.2, we need to compare a sequence of homeomorphisms  $\{\xi_n : n \geq m\}$  (as in 8.1.6) associated to an element  $\beta \in R_{m,0}$  with  $\{\xi_{n,0} : n \geq m\}$ . We shall relate  $\xi_n \circ \xi_{n,0}^{-1}$  to  $\xi_{n-1} \circ \xi_{n-1,0}^{-1}$ . So let  $(\beta_n, \beta_{n,2})$  be an adjacent pair in  $R_{n,0}$ , such that:

- $\beta'_n \in R_{n,0}$  is matched with  $\beta_n$ ,
- $\beta_n$  and  $\beta_{n,2}$  are between  $\beta_{n-1}$  and  $\beta_{n-1,2}$ ,
- $\beta_0 = \beta_{2/7}$ ,  $\alpha_0 = \alpha_{0,2/7}$ ,  $\psi_0 = \psi_{0,2/7}$ ,
- $\alpha_n$  is homotopic, up to homotopy preserving  $n$ , to a perturbation of  $\beta_n * \psi(\overline{\beta'_n})$  which separates the second endpoint of  $\beta_n$  from the second endpoint of  $\beta_{n,2}$ .
- As in (8.1.3) and (8.2.1),

$$(8.6.1) \quad \sigma_{\alpha_n} \circ s \circ \psi_{n+1} = \psi_n \circ s,$$

$$(8.6.2) \quad \psi_{n+1} = \xi_n \circ \psi_n,$$

$$(8.6.3) \quad \sigma_{\alpha_n} \circ s \circ \xi_n = \xi_{n-1} \circ \sigma_{\alpha_{n-1}} \circ s.$$

The *support* of a homeomorphism  $\xi$  is the set where it is not the identity, written  $\text{supp}(\xi)$ .

**Lemma** *The following holds.*

Let  $n$  be such that  $\psi_n = \psi_{n,0}$  and  $\alpha_{n-1} = \alpha_{n-1,0}$ . Then

$$s \circ \xi_n \circ \xi_{n,0}^{-1} = \sigma_{\alpha_n}^{-1} \circ \sigma_{\alpha_{n,0}} \circ s.$$

So in this case,

$$(8.6.4) \quad \text{supp}(\xi_n \circ \xi_{n,0}^{-1}) \subset s^{-1}(E_n),$$

where  $E_n$  is any disc which contains  $\overline{\alpha_n} * \alpha_{n,0}$ .

For any other  $n$ ,

$$(8.6.5) \quad \sigma_{\beta_n} \circ s \circ \xi_n \circ \xi_{n,0}^{-1} = \xi_{n-1} \circ \xi_{n-1,0}^{-1} \circ \sigma_{\zeta_n} \circ \sigma_{\beta_n} \circ s,$$

where

$$\zeta_n = \zeta_{n,1} * \zeta_{n,2},$$

and  $\zeta_{n,1}$  and  $\zeta_{n,2}$  are arbitrarily small perturbations of, respectively,

$$\overline{\beta_n} * \beta_{k_0} * \xi_{n-1,0}(\overline{\beta_{k_0}} * \beta_n)$$

and

$$\xi_{n-1,0}(\overline{\beta_n} * \beta_{n-1} * \psi_{n-1}(\overline{\beta'_{n-1}} * \beta'_n))$$

where  $\zeta_{n,1}$  does not contain  $v_2$  or the endpoints of either  $\beta_n$  or  $\beta_{k_0}$ , and  $\zeta_{n,2}$  contains  $v_2$  and, if  $\beta_n \neq \beta_{n-1}$ , also contains the endpoint of  $\beta_n$ , but not of  $\beta_{n-1}$ . (Otherwise, it does not contain the common endpoint.) So

$$\text{supp}(\xi_n \circ \xi_{n,0}^{-1}) \subset \cup_{k < n} E_{n,k},$$

where  $E_{k,k}$  is any suitably chosen disc which contains  $\zeta_k$ ,  $E_{k+1,k} = s^{-1}(E_{k,k})$ , and for  $r > k + 1$ ,  $E_{r,k}$  is defined inductively as

$$E_{r+1,k} = (\sigma_{\beta_r} \circ s)^{-1}(E_{r,k}).$$

Similar statements hold for  $\xi_{n,1}$  replacing  $\xi_{n,0}$  for  $n \geq k_1$ , and for  $\beta_{k_1}$  replacing  $\beta_{k_0}$ , for any fixed  $k_1$ , and  $\xi_{n,1}$  replacing  $\xi_{n,0}$ , where  $\xi_{n,1}$  is the sequence obtained by using  $\beta_{k_1}$  for  $n \geq k_1$ .

*Proof.* – We need to start the induction and find an expression for  $\xi_n \circ \xi_{n,0}^{-1}$  when  $\psi_n = \psi_{n,0}$  and  $\alpha_{n-1} = \alpha_{n-1,0}$ . We start from the expressions

$$\sigma_{\alpha_n} \circ s \circ \xi_n \circ \psi_n = \psi_n \circ \sigma_{\alpha_{n-1}} \circ s$$

and

$$\sigma_{\alpha_{n,0}} \circ s \circ \xi_{n,0} \circ \psi_{n,0} = \psi_{n,0} \circ \sigma_{\alpha_{n-1,0}} \circ s.$$

The two right-hand sides are equal, and  $\psi_n = \psi_{n,0}$ . So we obtain

$$\sigma_{\alpha_n} \circ s \circ \xi_n = \sigma_{\alpha_{n,0}} \circ s \circ \xi_{n,0}.$$

So

$$s \circ \xi_n \circ \xi_{n,0}^{-1} = \sigma_{\alpha_n}^{-1} \circ \sigma_{\alpha_{n,0}} \circ s,$$

which gives (8.6.4).

Now we aim to prove (8.6.5). We use (8.6.3) and the corresponding statement for the sequences  $\xi_{n,0}$  and  $\alpha_{n,0}$ , which is:

$$(8.6.6) \quad \sigma_{\alpha_{n,0}} \circ s \circ \xi_{n,0} = \xi_{n-1,0} \circ \sigma_{\alpha_{n-1,0}} \circ s.$$

This can be rewritten as

$$(8.6.7) \quad \sigma_{\alpha_{n-1,0}} \circ s \circ \xi_{n,0}^{-1} = \xi_{n-1,0}^{-1} \circ \sigma_{\alpha_{n,0}} \circ s.$$

So then from (8.6.3) and (8.6.7), we obtain

$$\begin{aligned} \sigma_{\alpha_n} \circ s \circ \xi_n \circ \xi_{n,0}^{-1} &= \xi_{n-1} \circ \sigma_{\alpha_{n-1}} \circ s \circ \xi_{n,0}^{-1} \\ &= \xi_{n-1} \circ \sigma_{\alpha_{n-1}} \circ \sigma_{\alpha_{n-1,0}}^{-1} \circ \xi_{n-1,0}^{-1} \circ \sigma_{\alpha_{n,0}} \circ s. \end{aligned}$$

With  $\beta = \beta_{k_0}$ , the right-hand side can be written as

$$\xi_{n-1} \circ \sigma_{\alpha_{n-1}} \circ \sigma_{\beta}^{-1} \circ \xi_{n-1,0}^{-1} \circ \sigma_{\beta} \circ \sigma_{\beta_n}^{-1} \circ \sigma_{\beta_n} \circ s.$$

This gives

$$\sigma_{\beta_n} \circ s \circ \xi_n \circ \xi_{n,0}^{-1} = \xi_{n-1} \circ \sigma_{\psi_{n-1}(\beta'_n)} \circ \sigma_{\alpha_{n-1}} \circ \sigma_{\beta}^{-1} \circ \xi_{n-1,0}^{-1} \circ \sigma_{\beta} \circ \sigma_{\beta_n}^{-1} \circ \sigma_{\beta_n} \circ s,$$

which gives

$$\sigma_{\beta_n} \circ s \circ \xi_n \circ \xi_{n,0}^{-1} = \xi_{n-1} \circ \xi_{n-1,0}^{-1} \circ \sigma_{\zeta_n} \circ \sigma_{\beta_n} \circ s,$$

where  $\zeta_n$  is as stated. The subsequent bound on  $\text{supp}(\xi_n \circ \xi_{n,0}^{-1})$  is then clear.

The similar statements with  $\beta_{k_0}$  and  $\xi_{n,0}$  replaced by  $\beta_{k_1}$  and  $\xi_{n,1}$  are proved in the same way.  $\square$

### 8.7. Definition of $U(\beta_1, \beta_2)$

We now define the sets  $U(\beta_1, \beta_2)$  for adjacent pairs  $(\beta_1, \beta_2)$  in  $R_{m,0}$ , for any  $m \geq 0$ . The structure is suggested by the examples in 7.4. In all cases,  $U(\beta_1, \beta_2)$  will have at most two components of intersection with  $\{z : |z| \leq 1\}$  which intersect  $Z_\infty$  nontrivially. We start by defining, for  $X \subset \overline{\mathbb{C}}$ ,

$$\text{ess}(X) = X \cap \{z : |z| \leq 1\}.$$

We are really only interested in  $\text{ess}(X)$  up to isotopy preserving  $Z_\infty$ .

The basic idea is to choose  $U(\beta_1, \beta_2)$  to be the union of  $D(w(\beta_2))$ , and everything between  $D(w(\beta_2))$  and the nearest disc-crossing of  $\beta_1$ , but this might not be quite appropriate, if the nearest disc crossing by  $\beta_1$  is not close by. So we define  $i$  as in 8.4, that is,  $i$  is the least integer  $\geq 0$  such that  $w'_{i+1}(\beta_1) \neq w'_{i+1}(\beta_2)$ . Note that  $D(w(\beta_1))$  and  $D(w(\beta_2))$  might not be adjacent in the unit disc. They will be adjacent if:

$$w_{i+1}(\beta_1) = w(\beta_1), \quad w_{i+1}(\beta_2) = w(\beta_2).$$

We consider two conditions:

1.  $w_i(\beta_1) = w_i(\beta_2)$ ;
2. if  $w(\beta_2)$  has a prefix of length  $\geq m - 6$  ending in  $BC$  or  $UC$ , then  $\beta_2$  is not minimal or maximal among paths  $\beta$  in  $R_{m,0}$  such that  $w(\beta)$  has this prefix.

*Case that 1 and 2 hold.* Referring to 8.4, we see that, since  $w(\beta_2)$  does not end in  $BC$  or  $UC$ , we are in case 1 of 8.4, and that:

- $w_{i+1}(\beta_2) = w(\beta_2)$ ;
- $w_{i+3}(\beta_1) = w(\beta_1)$ , that is,  $\beta_1$  has at most two more crossings than  $\beta_2$  – and at least as many crossings as  $\beta_2$ , since the assumption that  $w_i(\beta_1) = w_i(\beta_2)$  means that  $w(\beta_1) \neq w_i(\beta_1)$ .

The minimal path  $\beta_3$  with  $w'_{i+1}(\beta_3) = w'_{i+1}(\beta_1)$  is such that  $w(\beta_3)$  is of the same length as  $w'_{i+1}(\beta_1)$ , ending in  $R_1R_2C$  or  $L_2C$ , with  $D(w(\beta_3))$  adjacent to  $D(w'_{i+1}(\beta_1))$ . The closure of the set between  $D(w(\beta_3))$  and  $D(w(\beta_2))$  is  $D(v)$ , where  $v$  is of the same length as either  $w(\beta_2)$  or  $w(\beta_3)$  and is obtained from  $w(\beta_2)$  (or  $w(\beta_3)$ ) by replacing the last letter by  $R_3$ .

First suppose that  $w(\beta_1)$  does not both have length  $m + 2$  and end in  $R_1R_2C$ . Then

$$(8.7.1) \quad \text{ess}(U(\beta_1, \beta_2)) = D(w(\beta_2)) \cup D(v).$$

An example is given in 7.4 by  $w = L_3L_2R_3L_3L_2C$  and  $w' = L_3L_2R_3L_2C$ . If  $w$  does have length  $m + 2$  and end in  $R_1R_2C$ , then write  $w(\beta_1) = w'R_2C$ , and define

$$(8.7.2) \quad \text{ess}(U(\beta_1, \beta_2)) = D(w(\beta_2)) \cup D(v) \cup D(w'R_1).$$

In cases considered so far,  $\text{ess}(U(\beta_1, \beta_2))$  is connected.

*Case that 1 holds and 2 does not.* Now suppose that  $w(\beta_2)$  has a prefix  $x$  of length  $\geq m - 6$  ending in  $BC$  or  $UC$ , and such that  $\beta_2$  is minimal or maximal among paths  $\beta$  with  $x$  as a prefix. This includes all cases of  $w_i(\beta_1)$  and  $w_i(\beta_2)$  differing in just the last letter  $BC$  or  $UC$ . If  $\beta_2$  is maximal among such  $\beta$ , then let  $v$  be as above, and we define

$$(8.7.3) \quad \text{ess}(U(\beta_1, \beta_2)) = D(w(\beta_2)) \cup D(v) \setminus D(xL_1R_2UC).$$

Having excluded  $D(xL_1R_2UC)$  from  $(\beta_1, \beta_2)$ , we have to decide where to add it in. Let  $x_0$  be obtained from  $w(\beta_2)$  by deleting the maximal suffix containing only the letters  $BC$ ,  $UC$ ,  $L_1$  and  $R_2$ , apart from the last  $R_1R_2C$ . In the case when  $\beta_2$  is minimal among  $\beta$  such that  $w(\beta)$  has  $x$  as a prefix, but not minimal among  $\beta$  such that  $w(\beta)$  has  $x_0(BC$  or  $UC)$  as a prefix and the end word of  $x$  includes at least one  $UC$  and has length at least 4, we let  $x'$  be obtained from  $x$  by replacing the end  $UC(L_1R_2BC)^k$  by  $BC(L_1R_2UC)^k$ , and then

$$(8.7.4) \quad \text{ess}(U(\beta_1, \beta_2)) = D(w(\beta_2)) \cup D(v) \cup D(x'L_1R_2UC).$$

If  $\beta_2$  is minimal among  $\beta$  such that  $w(\beta)$  has  $x_0(BC$  or  $UC)$  as a prefix, then let  $y$  be the word ending in  $L_3L_2R_3L_3$  with  $D(y)$  adjacent to  $D(x_0C)$ , and with  $D(y)$  between  $D(w(\beta_1))$  and  $D(w(\beta_2))$ , with  $y$  of length  $\geq m$ , and, subject to these conditions, of the least possible length. Then we define

$$(8.7.5) \quad \text{ess}(U(\beta_1, \beta_2)) = D(w(\beta_2)) \cup D(v) \cup D(y).$$

If the prefix  $x$  does not include any letter  $UC$ , and is not minimal among  $\beta$  such that  $w(\beta)$  has  $x_0(BC$  or  $UC)$  as a prefix, then usually we use (8.7.1). But if  $x$  is of the form  $L_3^2L_2BC(L_1R_2BC)^k$  and  $w(\beta_2)$  (and  $w(\beta_1)$ ) start with  $(BCL_1R_2)^k(BC$  or  $UC)$ , then we define  $x' = BC(L_1R_2UC)^{k+1}$  and again use (8.7.4).

The purpose of these definitions (8.7.3) and (8.7.4) is to ensure that the set bounded by  $\overline{\beta_1} * \beta_2$  and  $\xi_{m,0}(\partial'U(\beta_1, \beta_2))$  is contained in  $D(x)$ . The addition of  $D(xL_1R_2UC)$ , or subtraction of  $D(x'L_1R_2UC)$ , is made so as to counteract the effect of  $\xi_{m,0}$ , for  $\xi_{m,0}$  as in 8.5.

*Case when 1 does not hold and 2 does hold.* Now suppose that  $i > 0$ ,  $w'_i(\beta_1) = w'_i(\beta_2)$  and  $w_i(\beta_1) \neq w_i(\beta_2)$ , that is, that 1 above does not hold, but assume for the moment that 2 above does hold. If  $w_i(\beta_1) = w(\beta_1)$ , then  $w_{i+1}(\beta_2) = w(\beta_2)$  is of the form  $w'R_2C$ . In this case, we define

$$(8.7.6) \quad \text{ess}(U(\beta_1, \beta_2)) = D(w(\beta_2)) \cup D(w'R_1).$$

Now suppose that  $w_i(\beta_1) \neq w(\beta_1)$ . Then both  $w'_{i+1}(\beta_1)$  and  $w'_{i+1}(\beta_2)$  end in  $L_3$ . Write  $w'_{i+1}(\beta_1) = uL_3$ . As before, define  $v$  to be the word of the same length as  $w(\beta_2)$ , with  $D(v)$  adjacent to  $D(w(\beta_2))$ , and ending in  $R_3$ . Then if  $i = 1$  and  $w'_1(\beta_1) = L_3$ , we have:

$$(8.7.7) \quad \text{ess}(U(\beta_1, \beta_2)) = D(w(\beta_2)) \cup D(v) \cup D(u),$$

and in all other cases, we have:

$$(8.7.8) \quad \text{ess}(U(\beta_1, \beta_2)) = D(w(\beta_2)) \cup D(v) \cup D(u) \setminus D(vL_3).$$

The set  $vL_3$  is of the form  $y$  for some other pair  $(\beta_1, \beta_2)$  as in (8.7.5). So the set which is excluded in (8.7.8) is added in in (8.7.5).

*Case when 1 does not hold and 2 does not hold.* This can only happen when  $i = 1$  and  $w'_1(\beta_1) = w'_1(\beta_2) = L_3$ , and  $w(\beta_2)$  starts  $L_3^2L_2UC$ . Then  $\beta_2$  is minimal among paths  $\beta$  which start with  $L_3^2L_2BC$ . Then  $w(\beta_2)$  starts with  $L_3^2L_2(BCL_1R_2)^nBCL_1R_1$  for some  $n \geq 0$ . The definition of  $U(\beta_1, \beta_2)$  in this case is similar to (8.7.5). We define  $v$  to be the word such that  $D(v)$  is sandwiched between  $D(L_3^2L_2C)$  and  $D(w(\beta_2))$ . We take  $y = BCL_1R_2(UCL_1R_2)^nUCL_1$  if this has length  $m - 2$ , and otherwise  $y$  is empty, and  $D(y)$  is empty. Then we define

$$(8.7.9) \quad \text{ess}(U(\beta_1, \beta_2)) = D(w(\beta_2)) \cup D(v) \cup D(y).$$

We define  $U(\beta_1, \beta_2)$  itself up to isotopy preserving  $Z_n$  for any  $n$ , by adding handles round arcs of  $\overline{\beta_1} * \beta_2$  to  $\text{ess}(U(\beta_1, \beta_2))$ .

**LEMMA 8.8.** – *The sets  $\text{ess}(U(\beta_1, \beta_2))$ , for  $(\beta_1, \beta_2)$  running over adjacent pairs in  $R_{m,0}$  with  $w'_1(\beta_2) = x$ , have disjoint interiors, and the union contains all sets  $D(w) \subset U^x$  with  $w$  of length  $\leq m + 1$ .*

*Also, if  $\beta$  is any path in  $R_{m,0}$  with  $w'_1(\beta) = x$  and  $(\beta_1, \beta_2)$  is adjacent in  $R_{n,0}$  for some  $n \geq m$  with  $w'_1(\beta_1) = x$ , then  $\beta$  has no transversal intersections with  $\partial'U(\beta_1, \beta_2)$ .*

*Proof.* – The sets  $D(w(\beta_2))$  are disjoint. The sets  $D(v)$  are associated with just one pair  $(\beta_1, \beta_2)$ , as are the sets

$$D(u), \quad D(w'R_1), \quad D(y),$$

where defined. So interiors are disjoint. Now we show that the union is as claimed. The first case of the definition of  $U(\beta_1, \beta_2)$  is when it is the region of the disc between the  $i$ 'th unit-disc-crossings of  $\beta_1$  and  $\beta_2$ , where these are the first crossings which are distinct. If  $w$  is a word of length  $\leq m + 1$ , the points in  $U^x \cap D(w)$  which are not in such a region are in sets of the form  $D(w'R_1)$  or  $D(u)$  or  $D(y)$ , where there are as in 8.7. The definition of  $U(\beta_1, \beta_2)$  is made to include all of these.

For the last part, if  $w'_1(\beta_2) \neq x$ , then the claim of no transversal intersections follows immediately, because  $\beta$  is contained in  $U^x$  after the first  $S^1$ -crossing, and  $U(\beta_1, \beta_2) \subset U^y$  for  $y \neq x$ . There are some intersections between sets  $U^x$  and  $U^y$ , which arise from the exceptional definitions of  $w'_1(w, x)$  (and  $w'_1(w, y)$ ) listed in 7.6: but none of these occurs adjacent to  $\beta_1$ , if  $\beta_1$  is the maximal path with  $w'_1(\beta_1) = x$ . So we can assume that  $w'_1(\beta_1) = w'_1(\beta_2) = x$ . Suppose that  $\beta$  intersects  $\partial U(\beta_1, \beta_2)$ . Then for some  $j$ ,  $w'_j(\beta)$  must be strictly between  $w'_{i+1}(\beta_1)$  and  $w'_{i+1}(\beta_2)$ , and  $w_{i-1}(\beta_1) = w_{i-1}(\beta_2)$  must be a prefix of  $w'_j(\beta)$  also. If  $w_i(\beta_1) \neq w_i(\beta_2)$ , then, since  $n \geq m$ , and  $\beta_1$  and  $\beta_2$  are adjacent,  $w_i(\beta)$  is not between  $w_i(\beta_1)$  and  $w_i(\beta_2)$ , and hence also not between  $w'_{i+1}(\beta_1)$  and  $w'_{i+1}(\beta_2)$ , giving a contradiction. If  $w_i(\beta_1) = w_i(\beta_2)$ , then  $w_i(\beta_1)$  is also a prefix of  $w(\beta)$ , and hence  $w_i(\beta) = w_i(\beta_1)$  and  $w'_j(\beta) = w'_j(\beta_1)$  for  $j \leq i$ . Then because  $\beta_1$  and  $\beta_2$  are adjacent,  $w'_{i+1}(\beta)$  is not between  $w'_{i+1}(\beta_1)$  and  $w'_{i+1}(\beta_2)$ , and  $w_{i+1}(\beta)$  is not between  $w'_{i+1}(\beta_1)$  and  $w'_{i+1}(\beta_2)$ . Then since  $j \geq i + 2$ , we see that  $w_{i+1}(\beta_1)$  is a prefix of  $w'_j(\beta)$ , and  $w'_j(\beta)$  is also not between  $w'_{i+1}(\beta_1)$  and  $w'_{i+1}(\beta_2)$ , giving the final contradiction.  $\square$

### 8.9. Preservation of $U(\beta_1, \beta_2)$ under local inverses

We are especially interested in the cases in which a set  $U(\beta_1, \beta_2)$  is mapped by a local inverse of  $s^n$  to a set  $U(\beta_3, \beta_4)$ . From the definition given of  $U(\beta_1, \beta_2)$ , it is clear that this happens precisely when  $\bar{\beta}_1 * \beta_2$  is mapped by a local inverse of  $s^n$  to  $\bar{\beta}_3 * \beta_4$ . So for this, we need to refer to 7.7, and, more fundamentally, to (7.7.1) to (7.7.4). The definitions are such that, if  $S$  is a local inverse of  $s^n$  as in 7.9, or more generally a local homeomorphism as in 7.9, and  $(\beta_1, \beta_2)$  are adjacent in  $R_{m,0}$ , then there is an adjacent pair  $(\beta_3, \beta_4)$  in  $R_{m+n,0}$  such that

$$(8.9.1) \quad SU(\beta_1, \beta_2) = U(\beta_3, \beta_4),$$

and conversely, if  $(\beta_3, \beta_4)$  is an adjacent pair in  $R_{m+n,0}$ , in the image of  $S$ , then there is an adjacent pair  $(\beta_1, \beta_2)$  in  $R_{m,0}$  such that (8.9.1) holds.



### 8.10. Definition of $V(\beta_1, \beta_2, n)$

Let  $(\beta_1, \beta_2)$  be an adjacent pair in  $R_{m,0}$ . Let  $\xi_{m,0}$  and  $\xi_{m,1}$  be as in 8.5. The following lemma means that if we define  $V(\beta_1, \beta_2, n)$  to be the union of sets  $U(\beta_3, \beta_4)$  with  $(\beta_3, \beta_4)$  adjacent in  $R_{n,0}$  and between  $\beta_1$  and  $\beta_2$ , then, up to isotopy preserving  $Z_{m+1}$ , and usually up to isotopy preserving  $Z_\infty$ , the set  $V(\beta_1, \beta_2, n+1)$  is also the region bounded by  $\overline{\beta_1} * \beta_2$  and  $\xi_{m,0}(\partial'U(\beta_1, \beta_2))$ , except in a few cases, when we shall see later that it is the region bounded by  $\overline{\beta_1} * \beta_2$  and  $\xi_{m,1}(\partial'U(\beta_1, \beta_2))$ .

**Lemma** *Let  $(\beta_1, \beta_2)$  be an adjacent pair in  $R_{m,0}$  and let  $i$  be the largest index with  $w'_i(\beta_1) = w'_i(\beta_2)$ , setting  $i = 0$  if  $w'_1(\beta_1) \neq w'_1(\beta_2)$ . If  $i \geq 1$ , set  $x = w'_1(\beta_1) = w'_1(\beta_2)$ . Then the region bounded by  $\overline{\beta_1} * \beta_2$  and  $\xi_{m,0}(\partial'U(\beta_1, \beta_2))$  is the union of arbitrarily small neighborhoods of sets  $U(\beta_3, \beta_4)$  for  $(\beta_3, \beta_4)$  adjacent in  $R_{m+1,0}$ , and  $\beta_1 \leq \beta_3 < \beta_4 \leq \beta_2$ , up to homotopy preserving  $Z_{m+1}$  except in the following cases. In cases 2 and 3, we compensate by taking the pointwise definitions of some  $\beta'_1$  and  $\beta'_2$  to be different in  $R'_{m+1,0}$  from the definitions in  $R'_{m,0}$ . Apart from these exceptional cases, the region and the union are equal up to homotopy preserving  $Z_\infty$ .*

1. There is  $\beta_3 \in R_{m,0}$  between  $\beta_1$  and  $\beta_2$  such that  $w = w(\beta_3)$  and  $x = w'_1(\beta_3)$ , and  $w'_{i+1}(w, x, 0)$  is one of the exceptional cases of definition in 7.6.
2. The difference is in a set  $D(y)$ , where  $y$  ends in  $(L_3 \text{ or } R_3)L_2R_3L_3$ . This happens when  $w_i(\beta_3) \neq w_i(\beta_4)$  for the largest  $i$  with  $w'_i(\beta_3) = w'_i(\beta_4)$ , except when  $i = 1$  and  $w'_1(\beta_3) = w'_1(\beta_4) = L_3$ . In all the cases with  $i > 1$ , there is a  $y$  as above with  $D(y)$  between  $D(w(\beta_3))$  and  $D(w(\beta_4))$  and with  $w_i(y, w'_1(\beta_3)) = y$ . It also happens when such a  $D(y)$  is between  $D(w(\beta_3))$  and  $D(w(\beta_4))$ , adjacent to  $D(v)$ , with  $\beta_3 < \beta_4$ , and  $\beta_4$  is minimal with  $v(BC \text{ or } UC \text{ or } C)$  as a prefix for some  $v$ .
3. The difference is in a word ending in  $D(y)$ , where  $y$  ends in  $(UCL_1R_1)^n BCL_1R_1R_2$ , and  $3n + 6 > m$ . This happens when such a  $D(y)$  is between  $D(w_i(\beta_3))$  and  $D(w_i(\beta_4))$ , again for the largest  $i$  such that  $w'_i(\beta_3) = w'_i(\beta_4)$ . It also happens if  $y = v(UCL_1R_1)^n BCL_1R_1R_2$  and  $\beta_3$  is maximal with  $w(\beta_3)$  having  $v(BC \text{ or } UC \text{ or } C)$  as a prefix.

*Proof.* – The first exceptional case occurs precisely when, if paths were defined using the sequences  $w'_i(w, 0)$  rather than  $w'_i(w, w'_1(w, 0), 0)$ , the paths between  $\beta_1$  and  $\beta_2$  would be different. In all other cases, the paths can equally well be defined using the sequences  $w'_i(w, 0)$ . So now we consider all these other cases

Recall that the support of  $\xi_{m,0}$  is  $A_{m,2/7} \cup C_{m,0}$ . The region bounded by  $\overline{\beta_1} * \beta_2$  and  $\xi_{m,2/7}(\partial'U(\beta_1, \beta_2))$  is

$$U(\beta_1, \beta_2) \cup D_1 \setminus D_2,$$

where  $D_1$  and  $D_2$  are as follows. The set  $D_1$  is the union of any beads on  $A_{m,2/7}$  or  $C_{m,0}$  which follow on from beads inside  $U(\beta_1, \beta_2)$  and such that the piece of string between the two beads first crosses  $\partial U(\beta_1, \beta_2)$  along  $\partial' U(\beta_1, \beta_2)$ . The set  $D_2$  is the union of any beads of  $A_{m,2/7}$  or  $C_{m,0}$  inside  $U(\beta_1, \beta_2)$  which follow on from pieces of string which cross  $\partial U(\beta_1, \beta_2)$ , and such that the crossing of this piece of string into  $U(\beta_1, \beta_2)$  is across  $\partial' U(\beta_1, \beta_2)$ .

Most pieces of string on  $C_{m,0}$  trace round inside gaps of  $L_{3/7}$ , or segments of the unit circle close to the boundary of a single gap, so that they have limited scope for intersecting sets  $\partial' U(\beta_1, \beta_2)$ . The definitions in (8.7.3) and (8.7.4) ensure that alternate strings, those from beads with words ending in  $UC$  to beads with words ending in  $BC$ , usually intersect precisely two sets  $\partial' U(\beta_1, \beta_2)$  and  $\partial' U(\beta_2, \beta_3)$ . The exceptions are words ending  $L_2 BC(L_1 R_2 UC)^{k+1}$  and  $L_3^3 L_2 BC(L_1 R_2 BC)^k$ . But such a piece of string is the image under  $S$ , for some local inverse of some  $s^n$  as in 7.9, of the piece of string on  $C_{m,2/7}$  connecting  $D(BC(L_1 R_2 BC)^k)$  and  $D(L_3^2 L_2 BC(L_1 R_2 BC)^k)$ . This piece of string also intersects precisely two sets  $\partial' U(\beta_1, \beta_2)$  and  $\partial' U(\beta_3, \beta_4)$ . So the action of  $C_{m,0}$  gives rise to the exceptions listed in 3 and the last exception in 2.

Now we consider  $A_{m,2/7}$ . Note that  $\text{ess}(U(\beta_1, \beta_2))$  includes  $D(w(\beta_2))$  and also a connected component  $D(v)$  which is adjacent to  $D(w(\beta_2))$ , except that in some cases  $D(vL_3)$  may be excluded. Let  $i$  be the index with  $w'_i(\beta_1) = w'_i(\beta_2)$  but  $w'_{i+1}(\beta_1) \neq w'_{i+1}(\beta_2)$ . There is a path  $\beta_3 \in R_{m+1,0}$  between  $\beta_1$  and  $\beta_2$  if and only if  $w'_i(\beta_3) = w'_i(\beta_2) = w'_i(\beta_1)$  and  $w'_{i+1}(\beta_3)$  is between  $w'_{i+1}(\beta_1)$  and  $w'_{i+1}(\beta_2)$ . Then  $D(w(\beta_3))$  is in  $D(v)$ , unless  $D(z)$  is in  $D(v)$ , for some  $z$  such that  $D(z)$  and  $D(z')$  are consecutive beads on some component of  $A_{m,2/7}$ , with  $D(z)$  preceding  $D(z')$ , and  $w(\beta_3) = z' L_2 C$ . In that case,  $z L_2 C = w(\beta_4)$ , where  $\beta_4 \in R_{m+1,0}$  is also between  $\beta_1$  and  $\beta_2$ . The solid boundary of  $U(\beta_1, \beta_2)$  is  $\overline{\beta_1} * \beta_2$ . So the string  $z \mapsto z'$  crosses  $\partial' U(\beta_1, \beta_2)$ , unless either  $D(z)$  and  $D(z')$  are both excluded from  $\text{ess}(U(\beta_1, \beta_2))$  or  $D(z)$  and  $D(z')$  are both included. If  $D(z)$  and  $D(z')$  are both excluded, then  $z = vL_3$  for a nontrivial  $v$ , and we are in case (8.7.8). In that case, the conditions of 5 of 7.5 imply that  $\beta_4$  is between  $\beta_1$  and  $\beta_2$ , and  $\beta_3$  is not. The definition of (8.7.8) ensures that  $D(z)$  is in the region bounded by  $\overline{\beta_1} * \beta_2$  and  $\xi_{m,0}(\partial' U(\beta_1, \beta_2))$ , and  $D(z')$  is not. If  $D(z)$  and  $D(z')$  are both included in  $U(\beta_1, \beta_2)$ , then we are in case (8.7.5), and then  $D(z')$  is in the region bounded by  $\overline{\beta_1} * \beta_2$  and  $\xi_{m,0}(\partial' U(\beta_1, \beta_2))$ , and  $D(z)$  is not. Condition 5 of 7.5 confirms that  $\beta_3$  is between  $\beta_1$  and  $\beta_2$  and  $\beta_4$  is not.

The proof of 8.2 is then completed by the following lemma.

LEMMA 8.11. – *Let  $(\gamma_1, \gamma_2)$  be an adjacent pair in  $R_{m,0}$ . Let  $i$  be maximal with  $w'_i(\beta_1) = w'_i(\beta_2)$  (possibly with  $i = 0$ ) and let  $x = w'_1(\gamma_1, 0)$ . Once again, let  $\xi_{m,0}$  and  $\xi_{m,1}$  be as in 8.5. Then, for  $m \geq k_0$ , intersections between  $\xi_{m,0}(\partial' U(\gamma_1, \gamma_2))$  and the support of  $\xi_{m,1} \circ \xi_{m,0}^{-1}$  occur only when  $i \geq 1$ , and there is  $\gamma_3$  between  $\gamma_1$  and  $\gamma_2$*

in  $R_{m+1,0}$  such that  $w'_{i+1}(w(\gamma_3), x, 0)$  is one of the exceptional cases of definition in 7.6. There are no intersections at all with the support of  $\xi_m \circ \xi_{m,1}^{-1}$ .

*Proof.* – Let  $(\beta_k, \beta_{k,2})$ ,  $E_n$  and  $E_{n,k}$  be as in 8.6, with  $(\gamma_1, \gamma_2) = (\beta_m, \beta_{m,2})$ . So  $E_{n,k}$  is obtained by taking successive preimages under maps  $\sigma_{\beta_j} \circ s$  of a small disc neighborhood  $E_{k,k}$  of the loop  $\zeta_k$  as in 8.6. We need to show that for  $r \leq m$  there are only limited intersections between  $E_{m,r}$  and  $\xi_{m,0}(\partial'U(\beta_1, \beta_2))$  for  $r \leq k_1$ , with these intersections corresponding to the exceptional definitions of  $w'_i(w, x, 0)$  in 7.6, and no intersections at all between  $E_{m,r}$  and  $\xi_{m,1}(\partial'U(\gamma_1, \gamma_2))$  for  $r > k_1$ .

The set  $E_{k,k}$  is nonempty only when either  $\beta_k \neq \beta_{k-1}$  or when  $\beta'_k \neq \beta'_{k-1}$ , or when the support of  $\xi_{k-1} \circ \xi_{k-1,0}^{-1}$  intersects  $\overline{\beta_k} * \beta_{2/7}$ . Note that the possibility of  $\beta'_{k-1} \neq \beta'_k$  does occur, even when  $\beta_k = \beta_{k-1}$ . These are the cases listed in 8.10, when a set bounded by  $\overline{\beta_{k-1}} * \beta_{k-1,2}$  and  $\xi_{k-1,k_0}(\partial'U(\beta_{k-1}\beta_{k-1,2}))$  (for  $k \leq k_1$ ) or  $\xi_{k-1,k_1}(\partial'U(\beta_{k-1}\beta_{k-1,2}))$  (for  $k > k_1$ ) is not the same up to homotopy preserving  $Z_\infty$  as the union of sets  $U(\gamma_3, \gamma_4)$  for pairs  $(\gamma_3, \gamma_4)$  of  $R_{k,0}$  between  $\beta_{k-1}$  and  $\beta_{k-1,2}$ .

The loop  $\zeta_{m-r,2}$  traces round the union of sets  $\xi_{m,0}(\partial U(\gamma_3, \gamma_4))$  for adjacent pairs  $(\gamma_3, \gamma_4)$  between  $\beta_{m-r-1}$  and  $\beta_{m-r}$ . It is usually the case that  $(\beta_{m-r-1}, \beta_{m-r})$  is an adjacent pair, but there can be a path between  $\beta_{m-r-1}$  and  $\beta_{m-r}$ . This means that components of  $s^{-r}(\zeta_{m-r,2})$  do not have transversal intersections with any set  $\partial'U(\gamma_5, \gamma_6)$ . We claim that the same is true for  $\zeta_{m-r,1}$ . This is because the preimage under  $s^{-t}$  of any piece of string in the support of  $\xi_{m-r-1,0}$  which crosses  $\overline{\beta_{m-r}} * \beta_{k_0}$ , and which intersects  $U^0$ , will cross the union of solid boundaries of sets  $U(\gamma_3, \gamma_4)$ , for adjacent pairs  $(\gamma_3, \gamma_4)$  in  $R_{m-r+t,0}$ , represented by a component of  $s^{-t}(\overline{\beta_{m-r}} * \beta_{k_0})$ , and will not cross any dashed boundary before the next bead. So the boundary of the set  $s^{-t}(\zeta_{m-r,2})$  has no transversal intersections with any set  $\xi_{m,0}(\partial'U(\gamma_5, \gamma_6))$ .

We now consider a component of  $E_{m,m-r}$  such that the corresponding component of  $E_{n,m-r}$ , for  $m-r+2 \leq n < m$ , does not intersect  $\beta_{n+1}$ . Then  $E_{m,m-r}$  is a component of  $s^{1-r}(E_{m-r+1,m-r})$ , and intersections with  $\xi_{m,0}(\partial'U(\gamma_1, \gamma_2))$  can only occur as intersections between  $\xi_{m,0}(\partial'U(\gamma_1, \gamma_2))$  and components of  $s^{-r}(\beta_{m-r})$ . For intersections between  $\xi_{m,1}(\partial'U(\gamma_1, \gamma_2))$  and components of  $s^{1-r}(E_{m-r+1,m-r})$ , for  $m-r \geq k_1$ , under the assumption that we are currently making on these components, we only need to consider components of the support of  $s^{-r}(\beta_{m-r})$  which intersect  $U^0$ . In fact, we shall consider, more generally, intersections with  $\xi_{m,0}(\partial'U(\gamma_3, \gamma_4))$ , for any adjacent pair  $(\gamma_3, \gamma_4)$  with  $w'_1(\gamma_3) = w'_1(\gamma_4)$ .

First we consider intersections between  $s^{-r}(\beta_{m-r})$  and  $\xi_{m,0}(\partial'U(\gamma_3, \gamma_4))$ . Any component of  $\xi_{n,1} \circ \xi_{n,0}^{-1}$ , for any  $n$ , which has support close to  $s^{-1}(\beta_{m-r})$ , can be broadly represented by

$$L_3^2 L_2 R_3(\text{bot}) \leftrightarrow (\text{top}) R_3 L_3 L_2 R_3$$

This means that the part of the homeomorphism supported near  $s^{-1}(\beta_{m-r})$  interchanges two discs in  $D(L_3^2 L_2 R_3 L_3)$  and  $D(R_3 L_3 L_2 R_3)$  along the line of the diagonal  $s^{-1}(\beta_{m-r})$ . We get corresponding components of  $\xi_{n+r,1} \circ \xi_{n+r,0}^{-1}$  by taking preimages under  $s^r$ . The second preimages are

$$(8.11.1) \quad L_3^4 L_2 R_3(\text{bot}) \leftrightarrow (\text{bot}) R_3 L_2 R_3 L_3 L_2 R_3,$$

$$(8.11.2) \quad R_3 L_3^3 L_2 R_3(\text{top}) \leftrightarrow (\text{top}) L_3 L_2 R_3 L_3 L_2 R_3,$$

$$(8.11.3) \quad L_2 R_3 L_3^2 L_2 R_3(\text{top}) \leftrightarrow (\text{bot}) L_1 R_2 R_3 L_3 L_2 R_3,$$

$$(8.11.4) \quad R_2 R_3 L_3^2 L_2 R_3(\text{bot}) \leftrightarrow (\text{top}) R_1 R_2 R_3 L_3 L_2 R_3.$$

We claim that only components of support of  $\xi_{m,1} \circ \xi_{m,0}^{-1}$  represented by further preimages of the first two will ever intersect  $\xi_{m,0}(\partial'U(\gamma_3, \gamma_4))$ , for any  $m$ . We can restrict to looking at any set  $\xi_{m,0}(\partial'U(\gamma_3, \gamma_4))$  which is not in the inverse orbit of some other  $\xi_{n,0}(\partial'U(\beta_7, \beta_8))$ , and a component of support of  $\xi_{m,1} \circ \xi_{m,0}^{-1}$  which intersects  $U^0$ , and which is not in the backward orbit of any other component of support of  $\xi_{n,1} \circ \xi_{n,0}^{-1}$  which also intersects  $U^0$ . For if  $\xi_{m,0}(\partial'U(\gamma_3, \gamma_4))$  is in the inverse orbit of some other  $\xi_{n,0}(\partial'U(\gamma_5, \gamma_6))$ , it can only intersect a component of support of  $\xi_{m,1} \circ \xi_{m,0}^{-1}$  if a component of support of  $\xi_{n,1} \circ \xi_{n,0}^{-1}$  intersects  $\xi_{n,0}(\partial'U(\gamma_5, \gamma_6))$ .

So now we consider the backward orbit of (8.11.1) and adjacent pairs  $(\gamma_3, \gamma_4)$  in  $R_{m,0}$  with  $w'_1(\gamma_3) = w'_1(\gamma_4)$ . The two immediate preimages are given by adjoining either  $(L_3, L_2)$  or  $(R_3, R_2)$ , that is, we have

$$(8.11.5) \quad L_3^5 L_2 R_3(\text{top}) \leftrightarrow (\text{top}) L_2 R_3 L_2 R_3 L_3 L_2 R_3$$

and

$$(8.11.6) \quad R_3 L_3^4 L_2 R_3(\text{bot}) \leftrightarrow (\text{bot}) R_2 R_3 L_2 R_3 L_3 L_2 R_3.$$

Any backward orbit of (8.11.6) passes through one of the following:

$$(8.11.7) \quad L_3 L_2 R_3 L_3^4 L_2 R_3(\text{bot}) \leftrightarrow (\text{bot left}) BCL_1 R_2 R_3 L_2 R_3 L_3 L_2 R_3,$$

$$(8.11.8) \quad R_3 L_2 R_3 L_3^4 L_2 R_3(\text{bot}) \leftrightarrow (\text{top right}) UCL_1 R_2 R_3 L_2 R_3 L_3 L_2 R_3,$$

$$BCL_1 R_1^{n-1} R_2 R_3 L_3^4 L_2 R_3(\text{bot left}) \leftrightarrow (\text{bot left}) BCL_1 R_1^n R_2 R_3 L_2 R_3 L_3 L_2 R_3,$$

$$UCL_1 R_1^{n-1} R_2 R_3 L_3^4 L_2 R_3(\text{top right}) \leftrightarrow (\text{top right}) UCL_1 R_1^n R_2 R_3 L_2 R_3 L_3 L_2 R_3.$$

There is no intersection of the component of  $\xi_{m,1} \circ \xi_{m,0}^{-1}$  identified by (8.11.7) with  $\xi_{m,0}(\partial'U(\gamma_3, \gamma_4))$ , for any adjacent pair  $(\gamma_3, \gamma_4)$  in  $R_{m,0}$ . We see this as follows. Note that most of the sets  $U(\gamma_3, \gamma_4)$  have solid boundary on the left side of  $D(BC)$  and dashed boundary on the right. The only set  $\xi_{m,0}(\partial'U(\gamma_3, \gamma_4))$  which spans both  $D(BC)$  and  $D(L_3)$  is the longest one of all, which passes from the bottom righthand side of  $D(BC)$  to  $D(L_3^4)$ . Similarly, there is no intersection of the component of

$\xi_{m,1} \circ \xi_{m,0}^{-1}$  identified by (8.11.8) with  $\xi_{m,0}(\partial'U(\gamma_3, \gamma_4))$ , for any adjacent pair  $(\gamma_3, \gamma_4)$  in  $R_{m,0}$ . Applying the prefix and substitution rules of (8.9) for the shape of sets  $\partial'U(\gamma_3, \gamma_4)$ , there are no intersections in the other cases also.

So we consider the backward orbit of (8.11.5) obtained by adjoining  $(uL_3, uL_2)$ . Because of the conditions of 5 of 7.5, the presence of intersections, or not, is determined by the longest suffix of  $u$  which consists only of the letters  $L_2$ ,  $L_3$  and  $R_3$ , of the form  $u_1 \cdots u_n L_3$  described in 5 of 7.5, that is,  $n \geq 1$ ,  $u_i = L_3(L_2 R_3)^{m_i} L_3^{r_i-1}$  with  $m_i + r_i = 3$  for  $i \geq 2$ ,  $m_1 + n_1$  is odd and  $\geq 3$ , and  $m_1 \geq 1$ . Then intersection occurs with a set  $\xi_{m,0}(\partial'U(\gamma_3, \gamma_4))$  if, and only if,  $n$  is odd. The definition of  $w'_i(\gamma_3)$  in these cases was chosen precisely so that the region bounded by  $\bar{\gamma}_3 * \gamma_4$  and  $\xi_{m,1}(\partial'U(\gamma_1, \gamma_2))$  is the union of the sets  $U(\gamma_5, \gamma_6)$  for adjacent pairs  $(\gamma_5, \gamma_6)$  in  $R_{m+1,0}$  between  $\gamma_3$  and  $\gamma_4$ . These are the exceptions identified in 7.6.

Now we consider (8.11.2). It is probably worth pointing out that, whenever this case arises,  $\beta_{m-r} \neq \beta_{k_0}$ , and therefore the immediate preimage is definitely under  $s^{-1}$ . We have two immediate preimages that we can adjoin immediately:

$$(8.11.9) \quad R_2 R_3 L_3^3 \text{top} \leftrightarrow \text{top} R_3 L_3 L_2 R_3 L_3$$

and

$$(8.11.10) \quad L_2 R_3 L_3^3 \text{bot} \leftrightarrow \text{bot} L_3^2 L_2 R_3 L_3$$

Preimages of (8.11.10) are similar to (8.11.5) but, with top and bottom reversed. This gives rise to some intersection with sets  $\xi_{m,0}(\partial'U(\gamma_3, \gamma_4))$ , which, as with (8.11.5), arise exactly in the circumstances identified in (7.6).

For (8.11.9) we have further preimages defined by similar words to (8.11.6):

$$(8.11.11) \quad BCL_1 R_2 R_3 L_3^3 (\text{bot right}) \leftrightarrow (\text{bot}) R_3 L_2 R_3 L_3 L_2 R_3 L_3,$$

$$(8.11.12) \quad UCL_1 R_2 R_3 L_3^3 (\text{top left}) \leftrightarrow (\text{top}) L_3 L_2 R_3 L_3 L_2 R_3 L_3,$$

$$(8.11.13) \quad BCL_1 R_1^n R_2 R_3 L_3^3 (\text{bot right}) \leftrightarrow (\text{bot right}) BCL_1 R_1^{n-1} R_2 R_3 L_3 L_2 R_3 L_3,$$

$$(8.11.14) \quad UCL_1 R_1^n R_2 R_3 L_3^3 (\text{top left}) \leftrightarrow (\text{top left}) BCL_1 R_1^{n-1} R_2 R_3 L_3 L_2 R_3 L_3.$$

No preimage of (8.11.11) to (8.11.14) intersects any set of the form  $\xi_{m,0}(\partial'U(\gamma_3, \gamma_4))$ , for similar reasons to (8.11.6), that is, for similar reasons to (8.11.7) and (8.11.8).

Now we consider preimages of (8.11.3). The first preimages are

$$(8.11.15) \quad L_3 L_2 R_3 L_3^2 L_2 R_3 (\text{bot}) \leftrightarrow (\text{bot right}) BCL_1 R_2 R_3 L_3 L_2 R_3,$$

and

$$(8.11.16) \quad R_3 L_2 R_3 L_3^2 L_2 R_3 (\text{top}) \leftrightarrow (\text{top left}) UCL_1 R_2 R_3 L_3 L_2 R_3.$$

The track in (8.11.15) does not intersect any set  $\xi_{m,0}(\partial'U(\gamma_3, \gamma_4))$  for  $6 \leq m$ . We see this as follows. The longest dashed boundary  $\xi_{m,0}(\partial'U(\gamma_3, \gamma_4))$  which spans both

$D(BC)$  and  $D(L_3)$  passes on the outside of the track of (8.11.15), and apart from this, there are no other dashed boundaries which intersect either  $BCL_1R_2R_3L_3L_2R_3$  or  $D(L_3L_2R_3L_3^2L_2R_3)$  which are not preimages of others. The same is true if we adjoin any  $(u, u')$ , by the rules of 8.9. For (8.11.16): if we prefix by  $BCL_1R_2(R_3L_2)^n$  or by  $L_3L_2(R_3L_2)^n$  respectively then there are no intersections with any  $\xi_{m,0}(\partial'U(\beta_5, \beta_6))$  for  $9 + 2n \leq m$  or  $8 + 2n \leq m$  respectively, by inspection. The same is true for other choices of prefix, by the rules governing the sets  $\partial'U(\gamma_3, \gamma_4)$  in 8.9.

The case of (8.11.4) is similar. All preimages are further preimages of

$$L_1R_1^nR_2R_3L_3^2L_2R_3(\text{top}) \leftrightarrow (\text{bot})L_1R_1^{n+1}R_2R_3L_3L_2R_3.$$

Prefixing by  $BC$ , we have

$$(8.11.17) \quad BCL_1R_1^nR_2R_3L_3^2L_2R_3(\text{bot left}) \leftrightarrow (\text{bot right})BCL_1R_1^{n+1}R_2R_3L_3L_2R_3.$$

We see that there are no intersections with  $\xi_{m,0}(\partial'U(\gamma_3, \gamma_4))$  for  $6 + n \leq m$ , because any set  $\xi_{m,0}(\partial'U(\gamma_3, \gamma_4))$  with  $w(\gamma_3)$  starting with  $BCL_1R_1^nR_2R_3L_3^2$  and with  $\gamma_3 < \gamma_4$  has  $w(\gamma_4)$  starting with  $BCL_1R_1^{n+1}R_2BC$ , which is shorter than the track of (8.11.17). Then there are no intersections by attaching prefixes, by the rules governing the sets  $\partial'U(\gamma_3, \gamma_4)$ . The same is true if we attach  $UC$  and a prefix.

Now we consider what happens when we drop the assumption that successive components of  $s^{-k}(E_{m-r+1, m-r})$  avoid  $\beta_{m-r+k+1}$ . So suppose a component of  $s^{-k}(E_{m-r+1, m-r})$  intersects  $\beta_{m-r+k+1}$ . We point out that this can happen, and, indeed, it is possible for a component of  $s^{-k}(E_{m-r+1, m-r})$  to intersect the initial segment of  $\beta_{m-r+k+1}$ . Whenever there is intersection with an initial segment, there is an intersection between a component of  $s^{-i}(E_{m-r+1, m-r})$  and  $\beta_{2/7}$  for some  $i \leq k$ , with  $i < k$  unless the initial segments of  $\beta_{m-r+k+1}$  and  $\beta_{2/7}$  coincide, and taking further preimages of this, as necessary, produces the intersection between  $s^{-k}(E_{m-r+1, m-r})$  and  $\beta_{m-r+k+1}$ . In the same way, intersections between  $s^{-k}(E_{m-r+1, m-r})$  and any segment of  $\beta_{m-r+k+1}$  arise as preimages of an intersection between a path  $\gamma$  whose first  $S^1$ -crossing is at  $e^{2\pi i(2/7)}$  and a component  $E' s^{-i}(E_{m-r+1, m-r})$  for some  $i \leq k$ . We consider  $(\sigma_\gamma \circ s)^{-1}(E')$ . This has two components, both close to  $s^{-1}(\beta_{2/7})$ . We then consider the backward orbits as before, as in (8.11.1) to (8.11.16). The backward orbits are on either side of the backward orbits of  $s^{-1}(\beta_{2/7})$  and we see that preimages which come close to  $\xi_{m,0}(\partial'U(\gamma_3, \gamma_4))$  – given by (8.11.5), (8.11.10), (8.11.11) and (8.11.12) as before – either inside, or outside,  $\xi_{m,0}(\partial'U(\gamma_3, \gamma_4))$ , and intersections are avoided.

This completes the proof that the support of  $\xi_{m,1} \circ \xi_{m,0}^{-1}$  intersects exactly those sets  $\xi_{m,0}(\partial'U(\gamma_3, \gamma_4))$  that it is required to. We still have to show that the support of  $\xi_m \circ \xi_{m,1}^{-1}$  does not intersect  $\xi_{m,1}(\partial'U(\gamma_1, \gamma_2))$ . It suffices to show that  $E_{m, m-r}$  does not intersect any set  $\xi_{m,1}(\partial'U(\gamma_3, \gamma_4))$  for any pair  $(\gamma_3, \gamma_4)$  with  $w'_1(\gamma_3) =$

$w'_1(\beta_{k_1,1})$ , for  $m - r > k_1$ . As in the previous case, we consider intersections with  $s^{1-r}(E_{m-r+1,m-r})$ . As before, it is certainly true that  $s^{1-r}(E_{m-r+1,m-r})$  does not intersect  $\xi_{m,1}(\partial'U(\gamma_3, \gamma_4))$ . So we need to show that  $s^{-r}(\beta_{m-r})$  does not intersect  $\xi_{m,1}(\partial'U(\beta_5, \beta_6))$ . So we use the same analysis as in (8.11.1) to (8.11.4). Intersections with backward orbits of sets as in (8.11.1) and (8.11.2) are now avoided, precisely because of the definitions of sets  $U(\beta_5, \beta_6)$  for adjacent pairs  $(\gamma_3, \gamma_4)$  for which  $w'_1(\gamma_3) = w'_1(\beta_1)$ . Intersections with backward orbits of sets as in (8.11.3) and (8.11.4) are avoided as before. So there are no intersections, as required.  $\square$

## 8.12. Unsatisfying the Inadmissibility Criterion of 4.4

To complete the proof of the Main Theorem 7.11, we need to show that, for all  $m$  and  $p$ , the paths of  $R_{m,p}$  and  $R'_{m,p}$  do not satisfy the Inadmissibility Criterion of 4.4, so that they lie in  $D'$ . We have not defined the paths in  $R_{m,p}$  and  $R'_{m,p}$  at all precisely, but the only properties we shall use is that the the sets  $U(\beta_1, \beta_2)$ , for adjacent pairs  $(\beta_1, \beta_2)$  in  $R_{m,p}$ , lie in  $U^p$ , and the first  $S^1$ -crossing of any path in  $R_{m,p}$  is at  $e^{2\pi ix}$  for  $x \in [q_p, q_{p+1})$ . First we consider the case of  $R_{m,p}$ . We need to show the nonexistence of  $(\alpha, Q)$  as in the Inadmissibility Criterion. As pointed out in 4.4, this means that we have to analyse the lamination  $L(\beta)$ , for  $\beta \in R_{m,p}$ , and show that period 2 and period 3 leaves in  $L(\beta)$  cannot combine to form a set  $Q$ . So let  $\beta \in R_{m,p}$ . Then the only intersections between  $\beta$  and  $s^{-j}\beta$  for  $j \leq 3$  are between the first segment on  $\beta$  — that is, the segment nearest to  $v_2 = \infty$  — and the diagonal segment on  $s^{-1}(\beta)$ . This is because the first intersection of  $\beta$  with  $S^1$  is at  $e^{2\pi ix}$  for  $x \in [\frac{2}{7}, \frac{1}{3})$ , and all subsequent intersections are such that if  $I \in S^1$  is an interval with endpoints in common with a component of  $\beta \cap \{z : |z| > 1\}$ , then  $\beta \cap s^{-j}I = \emptyset$  for  $1 \leq j \leq 3$ . So the only leaves of  $L(\beta)$  of period  $\leq 3$  are the same as those for  $L_{3/7}$  or  $L_{3/7} \cup L_{6/7}^{-1}$ . So the Inadmissibility Criterion is not satisfied, as required.

The proof that the paths in  $R'_{m,p}$  lie in the admissible domain  $D'$  is also indirect, and uses induction. To start the induction,  $\beta_{5/7} \subset D'$ . It suffices to show that if  $\beta'_1 \in R'_{m+1,p}$  is adjacent to  $\beta'_0 \in R'_{m,p}$  and  $\beta'_0 \subset D'$ , then  $\beta'_1 \subset D'$  also. So suppose given such an adjacent pair  $(\beta'_0, \beta'_1)$  paired with adjacent pair  $(\beta_0, \beta_1)$  in  $R_{m,p}$ , and suppose that the matching is given by  $(\psi, \alpha)$ , that is,  $\alpha \in \pi_1(\bar{\mathbb{C}} \setminus Z_{m+1})$ , and  $[\psi] \in \text{Mod}(\bar{\mathbb{C}}, Y_{m+2})$  with

$$\begin{aligned} (s, Y_{m+2}) &\simeq_{\psi} (\sigma_{\alpha} \circ s, Y_{m+2}), \\ \alpha * \psi(\beta'_i) &= \beta_i \text{ rel } Y_{m+1}, \quad i = 0, 1. \end{aligned}$$

Then since  $\beta_0$  and  $\beta'_0 \subset D'$ , the element  $\gamma$  of  $\pi_1(B_{3,m+1}, s)$  with  $\rho(\gamma) = \alpha$  and  $\Phi_2(\gamma) = [\psi^{-1}]$  must actually be in  $\pi_1(V_{3,m+1}, s)$  and preserves  $D'$ , so that  $\beta'_1 \subset D'$ .  $\square$





## CHAPTER 9

### OPEN QUESTIONS

#### 9.1. Continuity of the Model

We end this paper by considering two lines of enquiry which arise. I have given little thought to the first of these, and have certainly made no progress myself, although others have made interesting advances in related research. Some progress has been made on the second line of enquiry

The fundamental domains that have been constructed for  $V_{3,m}$  give rise to an inverse limit  $\lim_{m \rightarrow \infty} M_m$ , which provides a model for the closure in  $V_3$  of the union of all type II and type III hyperbolic components within  $V_3$ . This union is not dense in  $V_3$ , because it omits all type IV hyperbolic components. The hope is that a quotient of it is a model for the complement of the type IV hyperbolic components.

The definition of the inverse limit uses the fact that the paths of  $R_m(\cdot)$  are defined up to isotopy preserving  $Z_n(s)$  for all  $n$ . The set  $M_m$  will be a union of sets

$$M_m(a_0), M_m(\bar{a}_0), M_m(a_1, -), M_m(a_1, +),$$

with some identifications on boundaries, but otherwise these sets are disjoint. We can form sets  $U(\beta_1, \beta_2)$  for  $(\beta_1, \beta_2)$  an adjacent pair in any of the sets  $R_m(a_0)$ ,  $R_m(\bar{a}_0)$ ,  $R_m(a_1, -)$ , exactly as for  $R_m(a_1, +)$ , except that there is a choice of which of the two pairs in a matching pair of adjacent pairs to take. This does not matter, because in these cases, if  $((\beta_1, \beta_2), (\beta'_1, \beta'_2))$  is a matching pair of adjacent pairs, then the boundary of the region  $U(\beta_1, \beta_2)$  contains both  $\bar{\beta}_1 * \beta_2$  and  $\bar{\beta}'_1 * \beta'_2$ , up to homotopy. This region can equally well be called  $U(\beta'_1, \beta'_2)$ . Then similarly to 8.1, we can define  $V(\beta_1, \beta_2, n)$  to be the union of all sets  $U(\beta_3, \beta_4)$  with  $(\beta_3, \beta_4)$  an adjacent pair in  $R_m(\cdot)$  between  $\beta_1$  and  $\beta_2$ , where  $(\beta_1, \beta_2)$  is an adjacent pair in  $R_m(\cdot)$  for some  $m \leq n$ . Then, using the notation of 4.5 for  $\beta_{1/7, c_1}$  and so on, we define

$$M_m(a_0) = V(\beta_{1/7, c_1}, \beta_{2/7, s(v_1)}, m) / \sim,$$

$$M_m(\bar{a}_0) = V(\beta_{6/7, c_1}, \beta_{5/7, s(v_1)}, m) / \sim,$$

$$M_m(a_1, -) = V(\beta_{1/7}, \beta_{6/7}, m) / \sim .$$

In each case, the relation  $\sim$  is simply the lamination equivalence relation for  $L_q, q = \frac{1}{7}, \frac{6}{7}, \frac{3}{7}$ . We also define

$$M_m(a_1, +) = \cup \{ (U(\beta_1, \beta_2) \times \{(\beta_1, \beta_2)\}) / \sim : (\beta_1, \beta_2) \text{ adjacent in } \cup_{p \geq 0} R_{m,p} \},$$

where, in this case,  $\sim$  is still to be determined completely, but for all pairs except when  $\beta_1 = \beta_{2/7}$ , the relation  $\sim$  identifies the solid and dashed boundary of  $U(\beta_1, \beta_2)$ . In the case of  $\beta_1 = \beta_{2/7}$ , we only identify parts of the solid and dashed boundary nearer the endpoint of  $\beta_2$ .

Now we need to determine how to glue together the different sets  $M_m(a_0)$  and  $M_m(\overline{a_0})$  and  $M_m(a_1, \pm)$ . Parts of the boundaries in the respective cases are

$$\begin{aligned} &\beta_{1/7, c_1} \cup \beta_{2/7, s(v_1)} \cup \beta_{4/7, c_1} \cup \beta_{4/7, s(v_1)}, \\ &\beta_{6/7, c_1} \cup \beta_{5/7, s(v_1)} \cup \beta_{3/7, c_1} \cup \beta_{3/7, s(v_1)}, \\ &\beta_{1/7} \cup \beta_{6/7}, \end{aligned}$$

and parts of  $\beta_{2/7}$  and  $\psi_{m,2/7}(\beta_{5/7})$  which form parts of the solid and dashed boundary of  $U(\beta_{2/7}, \beta_2)$ . These should be identified. We identify the free part of  $\beta_{2/7}$  — that is, the part which forms part of the solid boundary of  $U(\beta_{2/7}, \beta_2)$ , and which has not been identified with dashed boundary of  $U(\beta_{2/7}, \beta_2)$  — with part of  $\beta_{4/7, s(v_1)}$ . Similarly, we identify part of  $\psi_{m,2/7}(\beta_{5/7})$  with part of  $\beta_{3/7, s(v_1)}$ . These identifications are not so important. There is a natural map from  $M_m(\cdot)$  to  $M_{m+1}(\cdot)$  defined as follows. Let  $((\beta_1, \beta_2), (\beta'_1, \beta'_2))$  be a matching pair of adjacent pairs in  $R_m(\cdot)$ . In the case of  $a_0, \overline{a_0}$  or  $(a_1, -)$ , the sets  $U(\beta_1, \beta_2)$  and  $V(\beta_1, \beta_2, m + 1)$  have the same boundary and we choose a map from  $M_m(\cdot)$  to  $M_{m+1}(\cdot)$  which is the identity on this boundary. In the case of  $(a_1, +)$  we take  $(\beta_1, \beta_2)$  to be an adjacent pair in  $R_{m,p}$ , for some  $p$ , matched with  $(\beta'_1, \beta'_2)$  from  $R'_{m,p}$ . Then we map  $V(\beta_1, \beta_2, m + 1)$  to  $U(\beta_1, \beta_2)$ , by taking the identity on  $\overline{\beta_1} * \beta_2$  and  $\xi_m^{-1}$  on  $\psi_{m+1}(\overline{\beta'_1} * \beta'_2)$ . Then the inverse limits

$$\begin{aligned} &\lim_{m \rightarrow +\infty} M_m(a_0), \quad \lim_{m \rightarrow +\infty} M_m(\overline{a_0}), \quad \lim_{m \rightarrow +\infty} M_m(a_1, -), \\ &\quad \lim_{m \rightarrow +\infty} M_m(a_1, +) \end{aligned}$$

are well-defined, with neighborhood base given by sets  $V(\beta_1, \beta_2, m)$ . The analogue for this inverse limit space in the case of quadratic polynomials is simply the complement in the complex plane of the open unit disc. The combinatorial model for the Mandelbrot set complement and boundary is a quotient space of this, and the combinatorial model for the Mandelbrot set itself is a quotient of the closed unit disc. The big question is then the following.

*Question 1.* Is a quotient of  $\lim_{m \rightarrow \infty} M_m(\cdot)$  homeomorphic to the closure of the union of type II and type III hyperbolic components in  $V_3(\cdot)$ ?

This question has varying degrees of difficulty. The corresponding question for the Mandelbrot set is answered relatively easily in one direction. It is known that the combinatorial model for the Mandelbrot set is a continuous image of the true Mandelbrot set, because there is a continuous monotone map on the union of all type IV hyperbolic components and parameter rays of rational argument, with dense image in the combinatorial Mandelbrot set and this map has a unique continuous monotone extension. The difficulty lies in showing that this map is injective, and hence a homeomorphism. The parameter rays in the complement of the Mandelbrot set are the images of radial lines under the uniformising map from the exterior of the unit disc in the complex plane, to the exterior of the Mandelbrot set. The big Mandelbrot set question is then equivalent to the question of whether limits along rays exist. These parameter rays do have an analogue in  $V_3(a_0)$ ,  $V_3(\bar{a}_0)$ . Type III components in  $V_3(a_0)$  are connected together in a particularly simple way, mimicking connections between between Fatou components of  $h_{a_0}$ , excluding those Fatou components in the “forbidden limb”. So the analogue, in  $V_3(a_0)$ , of the parameter rays in the complement of the Mandelbrot set, is a collection of paths in the union of type III hyperbolic components and connecting points between two hyperbolic components, which extend through infinitely many hyperbolic components, with no backtracking, to limit points in the closure of the union. So these are limits of rays  $\omega_a$ , where  $\omega_a$  are the paths first mentioned in 4.5, and defined there in terms of image under  $\rho(\omega_a, s_{1/7})$ . The result about parameter rays of rational argument having limits then has a possible analogue given by the following question.

*Question 2.* Does the 1-1 correspondence  $\text{endpoint}(\rho(\omega_a, s_{1/7})) \mapsto \text{endpoint}(\omega_a)$  extend continuously to paths with periodic endpoints?

The analogue of this for  $V_2$  is proved in [1]. I think the analogue for  $V_3(a_0)$  and  $V_3(\bar{a}_0)$  should be reasonably straightforward. The question for  $V(a_1, -)$  looks harder. There is an analogue for  $V(a_1, +)$  and that looks harder still.

Related to continuity questions, but probably considerably easier, there are questions about type IV hyperbolic components. There has been no attempt in this paper to describe type IV hyperbolic components, because the method uses the results of [31], and that theory was not developed in the type IV case because of considerable technical difficulties. But it may well be possible to describe all type IV hyperbolic components by using the type III ones. In fact, this was the technique used in [29], where the idea used was that a parabolic parameter value on the boundary of a type IV hyperbolic component is approximated by a sequence of type III hyperbolic centres. One can ask if the corresponding sequence in the combinatorial model converges. If so, one would surely have a description of the type IV centres up to Thurston equivalence. More generally, one can ask:

*Question 3.* Can a complete description be given of the type IV hyperbolic components in  $V_3$ , and of their centres up to Thurston equivalence, by using the description of the type III hyperbolic components?

Question 3 is related to giving a complete description of all type IV hyperbolic components. As indicated in 2.8, it is known that all type IV hyperbolic components in  $V_3(a)$  for  $a = a_0$  or  $\overline{a_0}$ , are matings. I assume that all type IV hyperbolic components are matings in  $V(a_1, -)$  also. A complete proof would need a generalization of the main result of [31], and of the present paper, in order to deal with type IV centres, or some circumnavigation, which might well be possible, and certainly desirable. In order to describe completely all type IV hyperbolic components in  $V_3(a_1, +)$ , one would probably first have to answer the following purely combinatorial question, which should not be too hard.

*Question 4.* What are all possible limits of paths in  $\cup_{m,p} R_{m,p}$  such that the limits have periodic endpoints? Is the number of paths with endpoint of period  $n$  precisely twice the number of type IV hyperbolic components of period  $n$  in  $V_3(a_1)$ ?

If the answer to question 2 is “yes” for periodic rays, then the answer to question 5 is also “yes”, by the same argument as for the Mandelbrot set. The approximate analogue to this question for the Mandelbrot set is the known fact that the Mandelbrot set maps continuously onto its combinatorial model, by a map which sends hyperbolic components to their analogues in the model. (This known fact is an analogue of the result that a continuous monotone map from the rationals to a subset of  $\mathbb{R}$  with dense image has a unique continuous extension to a homeomorphism from  $\mathbb{R}$  to  $\mathbb{R}$ .)

*Question 5.* Does the map  $\omega_a \mapsto \rho(\omega_a, s_{1/7})$  extend continuously to a map of the closure of the union all type III components in  $V(a_0)$  onto a quotient of  $\lim_{m \rightarrow \infty} M_m(a_0)$ ?

A positive answer to question 2 in the case of  $V(a_1, -)$  would not so easily yield a positive answer to question 5 in the case of  $V(a_1, -)$ , because there is no clear definition of parameter rays in  $V(a_1, -)$ . Interesting work has been done recently by Timorin [41] on the boundaries of type III components, away from intersection points with boundaries of type II components. Away from such intersection points, he has described all boundary points up to topological conjugacy. His topological models are described a little differently, but certainly related to those used in [29].

A Markov partition which has come to be known as the Yoccoz puzzle has been an outstanding tool towards showing that the Mandelbrot set is homeomorphic to its combinatorial model, although the problem is not usually phrased in this way. This partition is a Markov partition for all polynomials in a *limb* of the Mandelbrot set. It pulls back to give successively finer Markov partitions on nonrenormalisable polynomials in the limb, and is a generating partition for all the nonrenormalisable

polynomials. The refined partitions are not topologically or combinatorially the same for all polynomials, but are controlled by the *critical puzzle pieces*, which occur at infinitely many levels. A partition of parameter space is obtained by partitioning according to the combinatorial nature of the refined partition up to level  $n$ , and in particular, of the critical puzzle pieces up to level  $n$ . So a Markov partition common to a set of polynomials gives rise to a partition of parameter space which Yoccoz showed to be a neighborhood base at each nonrenormalisable point ([12, 35]). Numerous refinements of this result have been obtained over the past 15 years or so e.g. [23]. There have also, as already mentioned, been analogous results for cubic polynomials, in the complement of the connectedness locus, and in non-Archimedean dynamics, and in other cases ([27, 34, 36]). Recently, Lyubich and Kahn and collaborators developed a Quasi-additivity Law [17] to extend the methods to unicritical polynomials ([2, 15]), a result which was, until now, elusive, and have also made other extensions ([13, 14, 16]) which appear to be very important.

Markov partitions which persist arise in each of the four parts of  $V_3$  which we have studied,  $V_3(a_0)$ ,  $V_3(\overline{a_0})$ , and  $V(a_1, \pm)$ , associated to the polynomials  $h_a$  for  $a = a_0, \overline{a_0}, a_1$ . As already mentioned in 2.8, a Yoccoz puzzle for  $V_2$ , introduced nonrigorously in Luo's thesis [22] was used by Aspenberg-Yampolsky [1] and Timorin [40] to prove essentially the same results about nonrenormalisable points that were proved by Yoccoz for the Mandelbrot set. It is likely that  $V(a_0)$  and  $V(\overline{a_0})$  can be treated in the same way. Recent discussion suggests that there is a chance that  $V_3(a_1, -)$  will also be eligible to such treatment. However, even in the simpler cases, the Markov partitions sketched out here are of a somewhat different nature to the Yoccoz puzzle. So if the answers to the following questions are essentially contained in the work of [1, 40], this needs checking, to say the least. For concreteness we consider the case of  $V_3(a_0)$ . An obvious question in the reverse direction of question 5, and a generalization of question 2, is:

*Question 6.* For  $a = a_0$  or  $\overline{a_0}$ , does the map  $\rho(\omega_a, s_{1/7}) \mapsto \omega_a$  extend continuously to a map of  $\lim_{m \rightarrow \infty} M_m(a)$  onto the closure of the union all type III components in  $V(a)$ ? What about the case of  $\lim_{m \rightarrow \infty} M_m(a_1, -)$  and  $V(a_1, -)$ ?

Intriguingly, a rather similar-looking question to question 6 about the parameter space of cubic polynomials has been answered by Kiwi and others. The techniques used in that case appear to be unavailable here, because in the cubic polynomial case there is an unbounded Fatou component in which one can draw rays of rational argument and show that these extend continuously. Rays of rational argument figure in the Yoccoz puzzle too of course. So perhaps something can be done in the case of  $a = a_0$  or  $\overline{a_0}$ , and even in the case of  $(a_1, -)$ .

The corresponding question for  $V(a_1, +)$  is harder to state. We use the sets  $V(\beta_1, \beta_2, n)$  of 8.1 and 8.10 for adjacent pairs  $(\beta_1, \beta_2)$  in  $R_{m,0}$ . These sets are not all disjoint, but sets  $V(\beta_1, \beta_2, n)$  with the same first  $S^1$ -crossing are disjoint. We have developed the theory only in the case of  $R_{m,0}$ , but a similar procedure can be carried out in  $R_{m,p}$  for any  $p \in \mathbb{Z}$  with  $p \geq 0$ .

One can then ask:

*Question 7.* Let  $(\beta_1, \beta_2)$  be adjacent in  $R_{m,0}$ , or more generally, in  $\cup_p R_{m,p}$ . Does the natural map from

$$V(\beta_1, \beta_2, m) \cap (\cup_n Z_n(s))$$

to centers of hyperbolic components in  $V_3$ , given by mapping endpoints of paths  $\rho(\omega_a)$  to endpoints of paths of  $\omega_a$ , extend continuously to  $\lim_{n \rightarrow \infty} V(\beta_1, \beta_2, n)$ ?

*Question 8.* If the answer to Question 6 is “yes”, does the diameter image of a set  $\lim_{n \rightarrow \infty} V(\beta_1, \beta_2, n)$  tend to 0 uniformly with  $n$ ? (Remember that  $\beta_1$  and  $\beta_2$  are assumed adjacent in  $\cup_p R_{m,p}$ .)

These questions are of course, intertwined and there are partial implications in both directions. But it does not seem worth spelling out implications without more idea on how to tackle such questions.

The famous quadratic polynomial analogue of the following, has not been answered but would follow from homeomorphism between the Mandelbrot set and its combinatorial model:

*Question 9.* Is the complement in  $V_3$  of the closure of the union of the type III hyperbolic components exactly equal to the union of type IV hyperbolic components?

## 9.2. Some nontrivial equivalences between captures

It will have been noticed that the part of the fundamental domain corresponding to  $V_3(a_1, +)$  has relatively few capture paths in it. In fact the proportion of such paths, for each  $m$ , is exponentially small (although growing exponentially with  $m$ ). I suspect that it is impossible to choose a fundamental domain with a significantly higher proportion of capture paths, although I cannot be sure. A rather elementary point is that captures  $\sigma_r \circ s_{3/7}$  and  $\sigma_{1-r} \circ s_{3/7}$  are usually not Thurston equivalent, even when  $\beta_r$  and  $\beta_{1-r}$  end at the same point of  $Z_m(s)$ . An example which was mentioned in 7.4 is given by  $r = \frac{65}{224}$ , so that  $\beta_r = \beta(L_3 L_2 R_3 L_3 L_2 C)$ . Then  $\sigma_{1-r} \circ s_{3/7}$  is Thurston equivalent to  $\sigma_{\beta'} \circ s_{3/7}$ , where  $\beta' = \beta(L_3^4 L_2 C)$ , and hence not Thurston equivalent to  $\sigma_r \circ s_{3/7}$ , because it can only be equivalent to one point in the fundamental domain.

It is also clear that Thurston equivalences between different captures can be quite complicated. Here is an example. We claim that the captures  $\sigma_r \circ s_{3/7}$  and  $\sigma_q \circ s_{3/7}$  are Thurston equivalent, where  $r = \frac{271}{896}$  and  $q = \frac{635}{896}$ . Note that  $r + q \neq 1$ . In fact,  $1 - r = \frac{625}{896}$  and  $\sigma_{1-q} \circ s$  and  $\sigma_{1-r} \circ s$  are also Thurston equivalent. We have  $e^{\pm 2\pi i r} \in \partial D(L_3(L_2R_3)^2L_3L_2C)$  and  $e^{\pm 2\pi i q} \in \partial D(L_3L_2R_3L_3^3L_2C)$ . Write  $w = L_3(L_2R_3)^2L_3L_2C$  and  $w' = L_3L_2R_3L_3^3L_2C$ . Now  $w_1(w', 0) = w'$  and  $\psi_{7,2/7}$  maps  $e^{\pm 2\pi i q}$  to  $e^{\pm 2\pi i r}$ . Although  $\psi_{7,2/7}$  does not map  $\beta_q$  to  $\beta_r$ ,  $\psi_{7,2/7}(\beta_q)$  and  $\beta_r$  are homotopic under a homotopy which fixes endpoints and preserves the forward orbit of the common second endpoint: because for any suffix  $u$  of  $w$ ,  $D(u)$  is not between  $D(w)$  and  $D(C)$ . So  $\sigma_q \circ s_{3/7}$  and  $\sigma_r \circ s_{3/7}$  are Thurston equivalent.

A question that remains is: how to identify all captures, up to Thurston equivalence, maps in the fundamental domain. Vertices of the fundamental domain in the three “easy” parts of the fundamental domain are represented by captures in any case. Easy identifications were described in 2.8. So we already know how the following captures are represented in the fundamental domain:

$$\begin{aligned} &\sigma_r \circ s_{1/7} \text{ for } r \in (2/7, 8/7), \\ &\sigma_r \circ s_{6/7} \text{ for } r \in (-1/7, 5/7), \\ &\sigma_r \circ s_{3/7} \text{ for } r \in (-1/7, 1/7). \end{aligned}$$

So the case to consider is the “hard” case:

$$\sigma_r \circ s_{3/7} \text{ for } r \in (2/7, 1/3) \cup (5/7, 2/3).$$

This can be done on a case-by-case basis, simply because, given a fundamental domain  $F$  in the unit disc  $D$ , for a free group of hyperbolic isometries with all vertices of  $F$  on  $\partial D$ , one can determine, for each vertex of a translate of  $F$ , the pair of vertices of  $F$  to whose orbit it belongs. Now  $\beta_r$  lifts to the set  $D'$  in the unit disc. Identifying  $D'$  with the universal cover of  $V_{3,m}$ , as the Resident’s View says we can do, the lift of  $\beta$  to  $D'$  has second endpoint at a lift of a puncture of  $V_{3,m}$ , and therefore the lift of  $\beta$  is contained in finitely many translates of the fundamental domain. Now  $\sigma_r \circ s_{3/7}$  must be Thurston equivalent to one of the maps represented in the fundamental domain. A priori, this map could be in  $V_{3,m}(a_0)$  or  $V_{3,m}(\overline{a_0})$ , or  $V_{3,m}(a_1, \pm)$ . However, it appears to be the case that the map is in  $V_{3,m}(a_1, +)$ , and is therefore of the form

$$\sigma_\zeta \circ s_{3/7}$$

for a unique  $\zeta = \zeta(r) \in \cup_p R_{m,p}$ . It also seems to be true that if  $r \in (q_p, q_{p+1}] \cup [1 - q_{p+1}, 1 - q_p)$  then  $\zeta(r) \in R_{m,p}$ . It was pointed out in 2.8 that the set of  $r \in (2/7, 1/3) \cup (2/3, 5/7)$  giving preperiod  $m$  captures  $\sigma_r \circ s_{3/7}$ , after reducing to exclude obvious Thurston equivalences, has cardinality asymptotic to  $\frac{1}{21}2^m$ , just half the asymptotic number of preperiod  $m$  type III hyperbolic components in  $V_{3,m}(a_1, +)$ .

In 3.4 we mentioned Jonathan Woolf's simple recurrence formula for the mean image size

$$n_2 \left( 1 - \left( 1 - \frac{1}{n_2} \right)^{n_1} \right)$$

of a map from a set  $A$  of  $n_1$  elements to a set  $B$  of  $n_2$  elements. We are, of course, interested in the case when  $n_1/n_2 \rightarrow 1/2$ . Much more detailed information can be obtained by using the saddle point method. It can be shown, for example, that, if  $n_2 \rightarrow \infty$  and  $n_1/n_2 \rightarrow a$ , the ratio of the image size to  $n_2$  tends to  $1 - e^{-a}$  with probability one, and a limiting normal distribution of image size can be obtained. It can also be shown that the the mean of the maximal inverse image size for maps  $f$  from  $A$  to  $B$ :

$$\text{Max}(\{\#(f^{-1}(b)) : b \in B\}),$$

is at least  $c \log n_2 / \log \log n_2$  for any  $c < 1$ , with probability tending to one as  $n_2 \rightarrow \infty$ , if  $n_1/n_2 \rightarrow a$ . This raises the following questions, concerning the specific map from the set of capture maps to maps in the fundamental domain:

- Can the proportion of preperiod  $m$  captures, up to Thurston equivalence, in  $V_{3,m}(a_1, +)$ , be computed? If so is it  $c2^m(1 + o(1))$  for some  $c > 0$  which can be determined?
- For each integer  $N$ , are there  $N$  different rational numbers  $r_j \in (\frac{2}{7}, \frac{1}{3}) \cup (\frac{2}{3}, \frac{5}{7})$  such that the captures  $\sigma_{r_j} \circ s_{3/7}$  are all Thurston equivalent?
- Are there computable asymptotes in  $m$  for the average number of captures  $\sigma_r \circ s_{3/7}$  which are Thurston-equivalent to a preperiod  $m$  capture  $\sigma_q \circ s_{3/7}$ , for  $q \in (\frac{2}{7}, \frac{1}{3}) \cup (\frac{2}{3}, \frac{5}{7})$ ?

I believe that:

- there is a constant  $c$  as in the first question, and it can probably be estimated, at least;
- the answer to the second question is “yes”: see [32].
- qualifying this “yes”, the *average* number of captures in a Thurston equivalence class is probably boundedly finite with probability tending to one as  $m \rightarrow \infty$ .



## BIBLIOGRAPHY

- [1] M. ASPENBERG & M. YAMPOLSKY – “Mating non-renormalizable quadratic polynomials”, *Comm. Math. Phys.* **287** (2009), p. 1–40.
- [2] A. AVILA, J. KAHN, M. LYUBICH & W. SHEN – “Combinatorial rigidity for unicritical polynomials”, *Ann. of Math.* **170** (2009), p. 783–797.
- [3] B. H. BOWDITCH – “Length bounds on curves arising from tight geodesics”, *Geom. Funct. Anal.* **17** (2007), p. 1001–1042.
- [4] ———, “End invariants of hyperbolic 3-manifolds”, preprint <http://www.warwick.ac.uk/~masgak/preprints.html>.
- [5] ———, “Geometric models for hyperbolic 3-manifolds”, preprint <http://www.warwick.ac.uk/~masgak/preprints.html>.
- [6] B. BRANNER & J. H. HUBBARD – “The iteration of cubic polynomials. I. The global topology of parameter space”, *Acta Math.* **160** (1988), p. 143–206.
- [7] ———, “The iteration of cubic polynomials. II. Patterns and parapatterns”, *Acta Math.* **169** (1992), p. 229–325.
- [8] J. BROCK, R. CANARY & Y. MINSKY – “The classification of Kleinian surface groups II: The ending laminations conjecture”, preprint <http://www.math.yale.edu/users/yair/research>, 2004.
- [9] J. BROCK, B. K., R. EVANS & J. SOUTO – in preparation.
- [10] A. DOUADY & J. H. HUBBARD – “Études dynamiques des polynômes complexes, avec la collaboration de P. Lavaurs, Tan Lei, P. Sentenac. Parties I and II”, Publications Mathématiques d’Orsay, 1985.
- [11] ———, “A proof of Thurston’s topological characterization of rational functions”, *Acta Math.* **171** (1993), p. 263–297.
- [12] J. H. HUBBARD – “Local connectivity of Julia sets and bifurcation loci: three theorems of J.-C. Yoccoz”, in *Topological methods in modern mathematics (Stony Brook, NY, 1991)*, Publish or Perish, 1993, p. 467–511.

- [13] J. KAHN – “A priori bounds for some infinitely renormalizable quadratics: I. Bounded primitive combinatorics”, preprint <http://front.math.ucdavis.edu/math.DS/0609045>.
- [14] J. KAHN & M. LYUBICH – “A priori bounds for some infinitely renormalizable quadratics. II. Decorations”, *Ann. Sci. Éc. Norm. Supér.* **41** (2008), p. 57–84.
- [15] ———, “Local connectivity of julia sets for unicritical polynomials”, *Ann. of Math.* **170** (2009), p. 413–426.
- [16] ———, “A priori bounds for some infinitely renormalizable quadratics. III. Molecules”, in *Complex dynamics* (D. Schleicher & N. Selinger, eds.), A K Peters, 2009, p. 229–254.
- [17] ———, “The quasi-additivity law in conformal geometry”, *Ann. of Math.* **169** (2009), p. 561–593.
- [18] J. KIWI – “Rational laminations of complex polynomials”, in *Laminations and foliations in dynamics, geometry and topology* (Stony Brook, NY, 1998) (M. Lyubich et al., eds.), Contemp. Math., vol. 269, Amer. Math. Soc., 2001, Volume arising from conference, SUNY at Stony Brook, 1998, p. 111–154.
- [19] ———, “Real laminations and the topological dynamics of complex polynomials”, *Adv. Math.* **184** (2004), p. 207–267.
- [20] ———, “Combinatorial continuity in complex polynomial dynamics”, *Proc. London Math. Soc.* **91** (2005), p. 215–248.
- [21] ———, “Puiseux series polynomial dynamics and iteration of complex cubic polynomials”, *Ann. Inst. Fourier (Grenoble)* **56** (2006), p. 1337–1404.
- [22] J. LUO – “Combinatorics and holomorphic dynamics: Captures, matings and Newton’s method”, Ph.D. Thesis, Cornell University, 1995.
- [23] M. LYUBICH – “Dynamics of quadratic polynomials. III. Parapuzzle and SBR measures”, *Astérisque* **261** (2000), p. 173–200.
- [24] J. MILNOR – “Geometry and dynamics of quadratic rational maps”, *Experiment. Math.* **2** (1993), p. 37–83.
- [25] ———, “Rational maps with two critical points”, *Exper. Math.* **9** (2000), p. 481–522.
- [26] Y. MINSKY – “The classification of Kleinian surface groups I”, *Ann. of Math.* **171** (2010), p. 1–107.
- [27] C. L. PETERSEN – “Puzzles and Siegel disks”, in *Progress in holomorphic dynamics*, Pitman Res. Notes Math. Ser., vol. 387, Longman, 1998, p. 50–85.

- [28] M. REES – “Components of degree two hyperbolic rational maps”, *Invent. Math.* **100** (1990), p. 357–382.
- [29] ———, “A partial description of parameter space of rational maps of degree two. I”, *Acta Math.* **168** (1992), p. 11–87.
- [30] ———, “A partial description of the parameter space of rational maps of degree two. II”, *Proc. London Math. Soc.* **70** (1995), p. 644–690.
- [31] ———, “Views of parameter space: Topographer and Resident”, *Astérisque* **288** (2003).
- [32] ———, “Multiple equivalent matings with the aeroplane polynomial”, *Ergod. Th. and Dynam. Syst.* **30** (2010), p. 1239–1257, with erratum on p. 1259.
- [33] ———, “The ending laminations theorem direct from teichmüller geodesics”, preprint arXiv:math/0404007.
- [34] P. ROESCH – “Puzzles de Yoccoz pour les applications à allure rationnelle”, *Enseign. Math.* **45** (1999), p. 133–168.
- [35] ———, “Holomorphic motions and puzzles (following m. shishikura)”, in *The Mandelbrot set, theme and variations*, London Math. Soc. Lecture Note Ser., vol. 274, Cambridge Univ. Press, 2000, p. 117–131.
- [36] ———, “On local connectivity for the julia set of rational maps: Newton’s famous example”, *Ann. of Math.* **168** (2008), p. 127–174.
- [37] J. STIMSON – “Degree two rational maps with a periodic critical point”, Ph.D. Thesis, University of Liverpool, 1993.
- [38] L. TAN – “Matings of quadratic polynomials”, *Ergodic Theory Dynam. Systems* **12** (1992), p. 589–620.
- [39] W. P. THURSTON – “On the geometry and dynamics of iterated rational maps”, in *Complex dynamics* (D. Schleicher & N. Selinger, eds.), A K Peters, 2009, p. 3–137.
- [40] V. TIMORIN – “External boundary of  $m_2$ ”, in *Proceedings of the Fields Institute dedicated to the 75th birthday of J. Milnor*, Fields Institute Communications, vol. 53, AMS, 2006, p. 225–267.
- [41] ———, “Topological regluing of holomorphic functions”, *Invent. Math.* **179** (2010), p. 461–506.
- [42] B. WITTNER – “On the bifurcation loci of rational maps of degree two”, Ph.D. Thesis, Cornell University, 1988.