

ATSUSHI SATO

ITIRO TAMURA

On transverse foliations

Publications mathématiques de l'I.H.É.S., tome 54 (1981), p. 5-35

http://www.numdam.org/item?id=PMIHES_1981__54__5_0

© Publications mathématiques de l'I.H.É.S., 1981, tous droits réservés.

L'accès aux archives de la revue « Publications mathématiques de l'I.H.É.S. » (<http://www.ihes.fr/IHES/Publications/Publications.html>) implique l'accord avec les conditions générales d'utilisation (<http://www.numdam.org/conditions>). Toute utilisation commerciale ou impression systématique est constitutive d'une infraction pénale. Toute copie ou impression de ce fichier doit contenir la présente mention de copyright.

NUMDAM

Article numérisé dans le cadre du programme
Numérisation de documents anciens mathématiques
<http://www.numdam.org/>

ON TRANSVERSE FOLIATIONS

by ITIRO TAMURA and ATSUSHI SATO

The structure of foliations displays a high degree of variability, and is generally far less rigid in contrast to complex structures. Thus, it is virtually impossible to give a precise description which characterizes effectively all foliations on a manifold, and the consequent lack of appropriate classification theorems seems to constitute a barrier to the derivation of precise results in foliation theory. However, if we fix some foliation on a manifold, and restrict our considerations to foliations having a definite relation with the given foliation (i.e. a structure of foliations on a foliated manifold), then a characterization of this class of foliations can often be obtained.

This paper deals with subfoliations of, and foliations transverse to, a given foliation. We shall establish classification theorems for codimension one foliations transverse to the Reeb component of $S^1 \times D^2$, and to the Reeb foliation of S^3 respectively (Theorems 1, 2, 3, 4 and 5).

Furthermore, as an application of Theorem 1, we shall prove that the foliations of codimension one of S^3 constructed from fibred knots do not admit any transverse foliation of codimension one (Theorem 6).

In Section 1, we define subfoliations, superfoliations, and transverse foliations. In Section 2, we consider a generalization of a result due to Reinhart, Davis and Wilson; this constitutes the starting point of our work. In Sections 3, 4 and 5, we study foliations of codimension one transverse to the Reeb component \mathcal{F}_R , the set of which is denoted by $t_1(\mathcal{F}_R)$. The existence of the half Reeb component and the TS components in $\mathcal{F}' \in t_1(\mathcal{F}_R)$ are proved in Sections 3 and 4, respectively. In Section 5, we give classification theorems for $t_1(\mathcal{F}_R)$. As a direct consequence of these theorems, the classification for foliations of codimension one transverse to the Reeb foliation of S^3 is derived in Section 6. In Section 7, we prove the non-existence of a foliation of codimension one transverse to a foliation of S^3 constructed from a fibred knot. The problems raised by the results of this paper are given in Section 8.

We wish to thank T. Mizutani, T. Tsuboi and K. Yano for valuable discussions.

1. Subfoliations, superfoliations and transverse foliations

Let M^n be an n -dimensional C^∞ manifold with or without boundary. Denote by $\mathcal{F}^{(k)}$ a C^r foliation of codimension k of M^n ($r \geq 0$), where, in case $\partial M^n \neq \emptyset$,

$$\mathcal{F}^{(k)} | \partial M^n = \{L \cap \partial M; L \in \mathcal{F}^{(k)}\}$$

is a C^r foliation of codimension $k-1$ or k of ∂M^n . Two C^r foliations $\mathcal{F}_1^{(k)}$ and $\mathcal{F}_2^{(k)}$ of codimension k of M^n are called *isomorphic* if there exists a C^r diffeomorphism $f: M^n \rightarrow M^n$ which preserves the leaves of $\mathcal{F}_1^{(k)}$ and $\mathcal{F}_2^{(k)}$.

Let $\mathcal{F}^{(k)}$ and $\mathcal{F}'^{(k')}$ be C^r foliations of codimensions k and k' of M^n respectively. Then $\mathcal{F}'^{(k')}$ is called a *subfoliation* of $\mathcal{F}^{(k)}$ and $\mathcal{F}^{(k)}$ is called a *superfoliation* of $\mathcal{F}'^{(k')}$, denoted by $\mathcal{F}'^{(k')} \prec \mathcal{F}^{(k)}$, if the following conditions hold:

(i) $k \leq k' \leq n$.

(ii) For any leaf L' of $\mathcal{F}'^{(k')}$, there exists a leaf L of $\mathcal{F}^{(k)}$ such that $L' \subset L$, and the restriction of $\mathcal{F}'^{(k')}$ on a leaf L of $\mathcal{F}^{(k)}$ is a C^r foliation of codimension $k' - k$ of L .

In case $r \geq 1$, it is obvious that, if $\mathcal{F}'^{(k')} \prec \mathcal{F}^{(k)}$ and $\mathcal{F}''^{(k'')} \prec \mathcal{F}'^{(k')}$, then $\mathcal{F}''^{(k'')} \prec \mathcal{F}^{(k)}$. Therefore the relation \prec is an order in the set of C^r foliations of M^n ($r \geq 1$).

Two subfoliations $\mathcal{F}_1'^{(k')}$ and $\mathcal{F}_2'^{(k')}$ of $\mathcal{F}^{(k)}$ are called *strongly isomorphic*, if there exists a C^r diffeomorphism $f: M^n \rightarrow M^n$ which preserves $\mathcal{F}^{(k)}$ and maps $\mathcal{F}_1'^{(k')}$ onto $\mathcal{F}_2'^{(k')}$.

Let $\tau(\mathcal{F}^{(k)})$ denote the subbundle of the tangent bundle $\tau(M^n)$ of M^n consisting of vectors tangent to leaves of $\mathcal{F}^{(k)}$. In order that $\mathcal{F}^{(k)}$ has a C^r subfoliation of codimension k' , it is necessary that $\tau(\mathcal{F}^{(k)})$ has a $(k' - k)$ -dimensional subbundle if $r \geq 1$.

A C^r foliation $\mathcal{F}'^{(k')}$ of codimension k' of M^n is called *transverse* to a C^r foliation $\mathcal{F}^{(k)}$ of M^n ($r \geq 1$), denoted by $\mathcal{F}'^{(k')} \bar{\cap} \mathcal{F}^{(k)}$, if the following conditions hold:

(i) $k + k' \leq n$.

(ii) Any leaves L of $\mathcal{F}^{(k)}$ and L' of $\mathcal{F}'^{(k')}$ intersect transversely in case $L \cap L' \neq \emptyset$.

Let $\mathcal{F}^{(k)} \cap \mathcal{F}'^{(k')}$ denote $\{L \cap L'; L \in \mathcal{F}^{(k)}, L' \in \mathcal{F}'^{(k')}\}$, then it is clear that $\mathcal{F}^{(k)} \cap \mathcal{F}'^{(k')}$ is a C^r foliation of codimension $k + k'$ which is a common subfoliation of $\mathcal{F}^{(k)}$ and $\mathcal{F}'^{(k')}$.

Two C^r foliations $\mathcal{F}_1'^{(k')}$ and $\mathcal{F}_2'^{(k')}$ which are transverse to $\mathcal{F}^{(k)}$ are called *strongly isomorphic*, if there exists a C^r diffeomorphism $f: M^n \rightarrow M^n$ which preserves $\mathcal{F}^{(k)}$ and maps $\mathcal{F}_1'^{(k')}$ onto $\mathcal{F}_2'^{(k')}$.

We note that the transversality $\mathcal{F}^{(k)} \bar{\cap} \mathcal{F}'^{(k')}$ is invariant under a small perturbation of $\mathcal{F}^{(k)}$ and $\mathcal{F}'^{(k')}$ respectively.

In order that $\mathcal{F}^{(k)}$ admits a transverse C^r foliation of codimension k' , it is necessary that $\tau(M^n)$ has an $(n - k')$ -dimensional subbundle which is transverse to $\tau(\mathcal{F}^{(k)})$ at each point of M^n if $r \geq 1$.

Example 1. — It is well known that a C^r foliation $\mathcal{F}^{(1)}$ of codimension 1 of M^n always admits a transverse C^r foliation of codimension $n - 1$ ($r \geq 1$).

Example 2. — Let $\mathcal{F}^{(2)}$ be a C^r foliation of codimension 2 of the 3-sphere S^3 consisting of compact leaves ($r \geq 1$). Then there exists no C^r foliation of codimension one which is transverse to $\mathcal{F}^{(2)}$. Because, if there exists a C^r foliation of codimension one transverse

to $\mathcal{F}^{(2)}$, say $\mathcal{F}^{(1)}$, then $\mathcal{F}^{(1)}$ contains a Reeb component by Novikov's theorem ([4]) which implies that $\mathcal{F}^{(2)}$ should contain non-compact leaves.

Example 3. — Let $\mathcal{F}^{(2)}$ be a C^r foliation of codimension 2 of S^3 which admits a superfoliation of codimension one, then $\mathcal{F}^{(2)}$ has a compact leaf. That is to say, the conjecture of Seifert holds in this case. Because a C^r foliation $\mathcal{F}^{(1)}$ of codimension one of S^3 having $\mathcal{F}^{(2)}$ as a subfoliation contains a Reeb component ([4]), and any subfoliation of a Reeb component has a compact leaf (see Proposition 2 of Section 2).

For a family $\{\mathcal{F}_\lambda^{(k)}\}_{\lambda \in \Lambda}$ of C^r foliations of codimension k of M^n , we denote by $t_j(M^n, \{\mathcal{F}_\lambda^{(k)}\})$ or simply by $t_j(\{\mathcal{F}_\lambda^{(k)}\})$ the family $\{\mathcal{F}_\sigma^{(k')}\}_{\sigma \in \Sigma}$ of C^r foliations of codimension k' such that $j = n - k - k'$ and that there exists $\mathcal{F}_\lambda^{(k)}$ transverse to $\mathcal{F}_\sigma^{(k')}$. Further we denote by $t_j^m(\{\mathcal{F}_\lambda^{(k)}\})$ the m fold iteration $t_j(t_j(\dots(t_j(\{\mathcal{F}_\lambda^{(k)}\})\dots))$ of t_j . It is obvious that the iterations of t_j have the property

$$t_j^m(\{\mathcal{F}_\lambda^{(k)}\}) \subset t_j^{m+2}(\{\mathcal{F}_\lambda^{(k)}\}) \quad (m \geq 1).$$

Now we give a sufficient condition for the existence of transverse plane fields for a C^r foliation:

Proposition 1. — Let M^n be a compact orientable n -dimensional C^∞ manifold and $\mathcal{F}^{(k)}$ a C^r foliation of codimension k ($r \geq 1$) such that, in case $\partial M^n \neq \emptyset$, $\mathcal{F}^{(k)}|_{\partial M^n}$ is a C^r foliation of codimension $k - 1$. Then, in order that M^n admits a $(k + 1)$ -plane field transverse to $\tau(\mathcal{F}^{(k)})$, it is sufficient that

$$H^j(M^n; \pi_{j-1}(S^{n-k-1})) = 0, \quad j = 1, 2, \dots, n.$$

In particular, any C^r foliation $\mathcal{F}^{(1)}$ of codimension one of S^3 admits a 2-plane field transverse to $\tau(\mathcal{F}^{(1)})$.

Proof. — The obstruction to construct a non-zero cross section of $\tau(\mathcal{F}^{(k)})$ lies in $H^j(M^n; \pi_{j-1}(S^{n-k-1}))$ ([1; Theorem (1.1)]). The $(k + 1)$ -plane field generated by the vector field of $\tau(\mathcal{F}^{(k)})$ and a k -plane field transverse to $\tau(\mathcal{F}^{(k)})$ has the required property.

2. Subfoliations of a foliation of codimension one defined by a fibering over S^1

In the following sections, we fix an orientation on the circle S^1 . The Reeb component of $S^1 \times D^2$ constructed by turbulizing ([4]) a collar of the boundary $S^1 \times \partial D^2$ in the minus (resp. plus) direction of S^1 is called the *plus Reeb component* (resp. the *minus Reeb component*) and denoted by $\mathcal{F}_R^{(+)}$ (resp. $\mathcal{F}_R^{(-)}$) (Fig. 1). That is, $S^1 \times \partial D^2$ has a contracting holonomy in the minus (resp. plus) direction of S^1 for $\mathcal{F}_R^{(+)}$ (resp. $\mathcal{F}_R^{(-)}$). We define the *plus Reeb component* $\overline{\mathcal{F}}_R^{(+)}$ (resp. the *minus Reeb component* $\overline{\mathcal{F}}_R^{(-)}$) of $S^1 \times D^1$ similarly (Fig. 2). We understand that $\mathcal{F}_R^{(\pm)}$, $\overline{\mathcal{F}}_R^{(\pm)}$ mean standard ones (i.e. leaves are "symmetric" with respect to an "axis" and $\{*\} \times D^2$ (resp. $\{*\} \times D^1$) is tangent to exactly one leaf of $\mathcal{F}_R^{(\pm)}$ (resp. $\overline{\mathcal{F}}_R^{(\pm)}$) at one point).

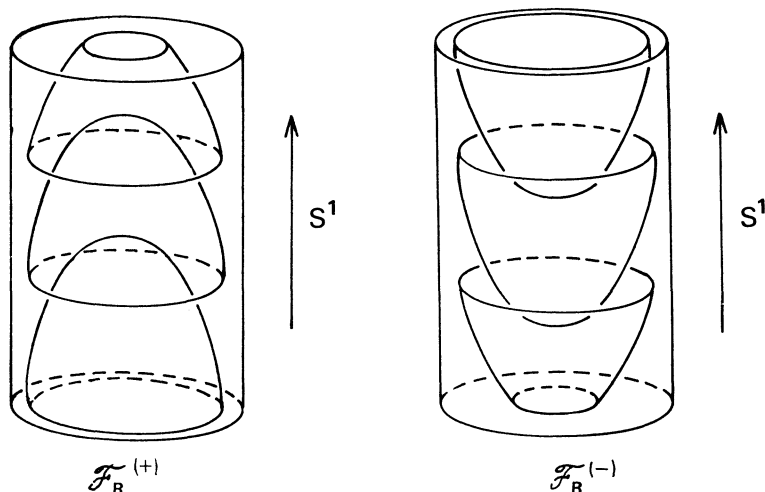

FIG. 1

A C^∞ foliation of codimension one of $S^1 \times D^1$ constructed by turbulizing a collar of $S^1 \times \{-1\}$ and $S^1 \times \{1\}$ in different directions is called a *slope component* and denoted by $\overline{\mathcal{F}}_S$ (Fig. 2). The set of vertices (i.e. maximal or minimal points) of leaves of $\overline{\mathcal{F}}_R^{(+)}$ (resp. $\overline{\mathcal{F}}_R^{(-)}$) is denoted by $\Sigma^{(+)}$ (resp. $\Sigma^{(-)}$) (Fig. 2).

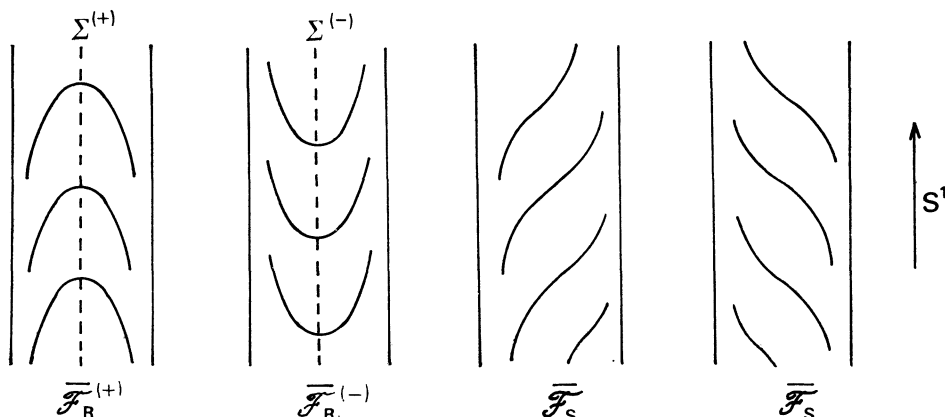

FIG. 2

Let E be a compact connected orientable 3-dimensional C^∞ manifold with boundary $\partial E = T^2$ (torus) and let $\pi : E \rightarrow S^1$ be a C^∞ fibering over S^1 with fibre $G - \text{Int } D^2$, where G is an orientable closed surface of genus g and D^2 is a 2-disc imbedded in G . The C^∞ foliation of codimension one of E constructed by turbulizing the fibers in a collar of the boundary ∂E in the minus (resp. plus) direction is denoted by $\mathcal{F}_\pi^{(+)}$ (resp. $\mathcal{F}_\pi^{(-)}$).

The following proposition is a generalization of a result of Reinhart, Davis and Wilson about tangent vector fields of the Reeb component ([1], [6]).

Proposition 2. — Let $\mathcal{F}^{(2)}$ be a C^∞ foliation of codimension 2 of E which is a subfoliation of $\mathcal{F}_\pi^{(+)}$. Denote by $\mathcal{F}^{(2)}|T^2$ the C^∞ foliation of codimension one of $\partial E = T^2$ which is the restriction of $\mathcal{F}^{(2)}$ to the compact leaf T^2 of $\mathcal{F}_\pi^{(+)}$. Then the following holds:

(i) $\mathcal{F}^{(2)}|T^2$ has a compact leaf.

(ii) $\mathcal{F}^{(2)}|T^2$ is isomorphic to a C^∞ foliation consisting of p copies of the plus Reeb component, q copies of the minus Reeb component (with respect to the orientation induced naturally from that of S^1), a countable number of slope components, and compact leaves (Fig. 3), for which, letting the homology class $[L_{\text{comp}}]$ of $H_1(T^2; \mathbf{Z})$ represented by a compact leaf L_{comp} of $\mathcal{F}^{(2)}|T^2$ with a suitable orientation be $a\alpha + b\beta$ ($a \geq 0$), the equation

$$a(p - q) = 2(1 - 2g)$$

holds, where α (resp. β) is the homology class represented by a cross section of π with the orientation compatible with that of the base space S^1 (resp. by $\partial(G - \text{Int } D^2)$).

(iii) In particular, if $G = S^2$, then we have

$$a = 1, \quad p - q = 2 \quad \text{or} \quad a = 2, \quad p - q = 1,$$

and $\tau(\mathcal{F}^{(2)})$ is orientable if and only if $a = 1$.

The number a in Proposition 2, (ii) is called the *longitudinal number* of $\mathcal{F}^{(2)}|T^2$.

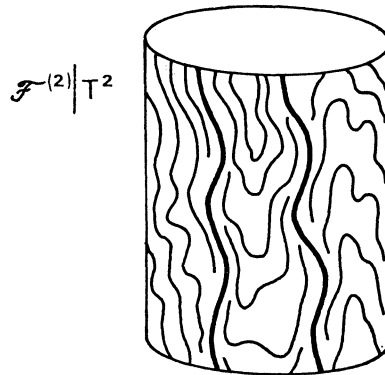

FIG. 3

Proof. — Let F be the line field on T^2 determined by $\mathcal{F}^{(2)}|T^2$, then F induces a homomorphism

$$F_* : H_1(T^2; \mathbf{Z}) \rightarrow H_1(P^1; \mathbf{Z})$$

([6]). If F_* is not a zero map, then $\mathcal{F}^{(2)}|T^2$ has a compact leaf ([6; Corollary 3]). Letting $c : T^2 \times I \rightarrow E$ be a collar of T^2 such that $c(x, 0) = x$ ($x \in T^2$), we define a projection $P : c(T^2 \times I) \rightarrow T^2$ by $P(c(x, t)) = x$. Let L be a leaf of $\mathcal{F}_\pi^{(+)}$ and let

$$\iota : G - \text{Int } D^2 \rightarrow L$$

be an imbedding such that

$$\iota(\partial(G - \text{Int } D^2)) \subset c(T^2 \times I).$$

Let F' be the line field on $\iota(G - \text{Int } D^2)$ determined by $\mathcal{F}^{(2)}|_{\iota(G - \text{Int } D^2)}$. If $F_*([P \circ \iota(\partial(G - \text{Int } D^2))]) = 0$, then the line field $F'|_{\iota(\partial(G - \text{Int } D^2))}$ should be homotopic to the line field tangent to $\iota(\partial(G - \text{Int } D^2))$. This implies that the Euler number $\chi(G)$ must be 1. This is a contradiction. Thus F_* is not a zero map and $\mathcal{F}^{(2)}|_{T^2}$ has a compact leaf.

As is easily verified ([1]), the existence of a compact leaf implies that $\mathcal{F}^{(2)}|_{T^2}$ is isomorphic to a C^∞ foliation consisting of p copies of the plus Reeb component, q copies of the minus Reeb component, a countable number of slope components, and compact leaves. Therefore we may choose the imbedding ι defined above so that it satisfies that $P \circ \iota(\partial(G - \text{Int } D^2))$ intersects $\mathcal{F}^{(2)}$ transversely except at $a(p+q)$ points corresponding to $\Sigma^{(+)}$ or $\Sigma^{(-)}$. Let \hat{G} be the double of $\iota(G - \text{Int } D^2)$, then F' defines a continuous line field on \hat{G} with ap singular points of plus type and aq singular points of minus type. Therefore, by computing the Euler number $\chi(G - \text{Int } D^2)$, we have

$$a(p-q) = 2(1-2g).$$

Thus (ii) is proved. The proof of (iii) is obvious.

3. Half Reeb components

Let D_+^2 denote the half 2-disc $\{(x, y) \in D^2; y \geq 0\}$. The restriction of the plus (resp. minus) Reeb component $\mathcal{F}_R^{(+)}$ (resp. $\mathcal{F}_R^{(-)}$) of $S^1 \times D^2$ to $S^1 \times D_+^2$ is called the *plus* (resp. *minus*) *half Reeb component* and denoted by $\mathcal{F}_{R/2}^{(+)}$ (resp. $\mathcal{F}_{R/2}^{(-)}$). Let \mathcal{F}'_+ (resp. \mathcal{F}'_-) denote the C^∞ foliation of codimension one of $S^1 \times D^2$ obtained from two copies of $\mathcal{F}_{R/2}^{(+)}$ (resp. $\mathcal{F}_{R/2}^{(-)}$) by identifying their compact leaves (Fig. 4).

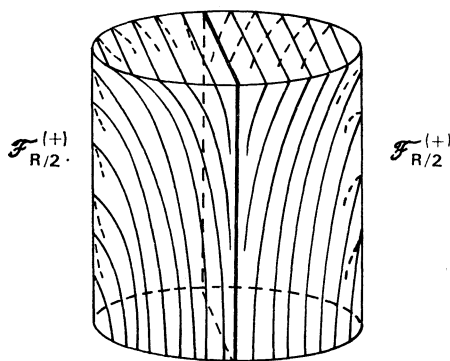

FIG. 4

It is well known that \mathcal{F}'_+ (resp. \mathcal{F}'_-) is transverse to $\mathcal{F}_R^{(+)}$ (resp. $\mathcal{F}_R^{(-)}$). (See, for example, [7].)

In Sections 3, 4 and 5, we let \mathcal{F}' be a C^∞ foliation of codimension one of $S^1 \times D^2$ transverse to $\mathcal{F}_R^{(+)}$:

$$\mathcal{F}' \in t_1(\mathcal{F}_R^{(+)}).$$

The C^∞ foliation $\mathcal{F}_R^{(+)} \cap \mathcal{F}'$ of codimension 2 of $S^1 \times D^2$ is a subfoliation of $\mathcal{F}_R^{(+)}$ (Section 1). Denote by $\overline{\mathcal{F}'}$ the restriction of $\mathcal{F}_R^{(+)} \cap \mathcal{F}'$ to $S^1 \times \partial D^2$. Then, by Proposition 2, the C^∞ foliation $\overline{\mathcal{F}'} = \{L \cap (S^1 \times S^1); L \in \mathcal{F}'\}$ is isomorphic to a C^∞ foliation $\overline{\mathcal{F}}$ consisting of p copies of the plus Reeb component, q copies of the minus Reeb component, a countable number of slope components, and compact leaves, for which Proposition 2, (iii) holds. Therefore there exists a C^∞ diffeomorphism $f: S^1 \times S^1 \rightarrow S^1 \times S^1$ isotopic to the identity such that f maps $\overline{\mathcal{F}}$ to $\overline{\mathcal{F}'}$ and that, for any $x \in S^1$, $f(\{x\} \times S^1)$ intersects $\overline{\mathcal{F}'}$ transversely except at $a(p+q)$ points $f(\{x\} \times S^1) \cap (\widehat{\Sigma}^{(+)} \cup \widehat{\Sigma}^{(-)})$, where $\widehat{\Sigma}^{(+)}$ (resp. $\widehat{\Sigma}^{(-)}$) denotes the union of $\Sigma^{(+)}$ (resp. $\Sigma^{(-)}$) of each plus (resp. minus) Reeb component contained in $\overline{\mathcal{F}}$ (Fig. 5).

We fix a natural product Riemannian metric on $S^1 \times D^2$. Let U be a neighborhood of $S^1 \times S^1$ in $S^1 \times D^2$ and let $V = \{V(z); z \in U\}$ be a C^∞ vector field on U satisfying the following conditions:

- (i) $|V(z)| = 1$;
- (ii) $V(z)$ is tangent to the leaf of \mathcal{F}' containing z ;
- (iii) for $z \in S^1 \times S^1$, $V(z)$ is inward and normal to the leaf of $\overline{\mathcal{F}'}$ containing z .

The existence of such a C^∞ vector field V is obvious.

For $z \in S^1 \times S^1$, let $\varphi(t, z)$ ($0 \leq t < \varepsilon_z$) denote the integral curve with the initial condition $\varphi(0, z) = z$. Let $\varepsilon > 0$ be sufficiently small and let $\bar{\varepsilon}: S^1 \rightarrow]0, \varepsilon[$ be a C^∞ function. Then, by a suitable choice of $\bar{\varepsilon}$, $\bigcup_{x \in S^1} \varphi(\bar{\varepsilon}(x), f(x, y_0))$ is transverse to $\mathcal{F}_R^{(+)}$. Denote by $L(x, y_0)$ ($(x, y_0) \in S^1 \times S^1$) the leaf of $\mathcal{F}_R^{(+)}$ containing $\varphi(\bar{\varepsilon}(x), f(x, y_0))$. Then there exists a unique C^∞ function

$$\gamma_x: S^1 \rightarrow]0, 1[$$

such that

$$\gamma_x(y_0) = \bar{\varepsilon}(x), \quad \varphi(\gamma_x(y), f(x, y)) \in L(x, y_0)$$

and that $\bigcup_{y \in S^1} \varphi(\gamma_x(y), f(x, y))$ is a simple closed curve in $L(x, y_0)$. Now we define

$$A = S^1 \times D^2 - \{\varphi(t, f(x, y)); 0 \leq t < \gamma_x(y), (x, y) \in S^1 \times S^1\}.$$

Then A is a 3-dimensional C^∞ manifold diffeomorphic to $S^1 \times D^2$, and $A \cap L$ is a closed 2-disk for each non-compact leaf L of $\mathcal{F}_R^{(+)}$. Let $\overline{\mathcal{F}''} = \{\partial A \cap L'; L' \in \mathcal{F}'\}$, then $\overline{\mathcal{F}''}$ is a C^∞ foliation of codimension one of ∂A . The C^∞ diffeomorphism $g: S^1 \times S^1 \rightarrow \partial A$ which maps (x, y) to $\varphi(\gamma_x(y), f(x, y))$ gives an isomorphism from $\overline{\mathcal{F}}$ to $\overline{\mathcal{F}''}$.

Denote by $A^{(x)}$ the intersection $A \cap L_x$, where L_x is the leaf of $\mathcal{F}_R^{(+)}$ containing $(x, 0) \in S^1 \times D^2$. By the construction above, $\partial A^{(x)}$ is a simple closed curve intersecting $\overline{\mathcal{F}''}$ transversely except at $a(p+q)$ points $\partial A^{(x)} \cap g(\widehat{\Sigma}^{(+)} \cup \widehat{\Sigma}^{(-)})$.

Obviously there exists a C^∞ diffeomorphism from A to $S^1 \times D^2$ which maps $A^{(x)}$ to $\{x\} \times D^2$. Thus, making use of the identification by this diffeomorphism, we may assume that

$$A = S^1 \times D^2, \quad A^{(x)} = \{x\} \times D^2,$$

and that the plus and the minus Reeb components in $\overline{\mathcal{F}}''$ of $\partial A = S^1 \times S^1$ are standard (as in Fig. 2). So we use the same notations $\widehat{\Sigma}^{(+)}, \widehat{\Sigma}^{(-)}$ for $\overline{\mathcal{F}}''$ as for $\overline{\mathcal{F}}$.

The intersection $A^{(x)} \cap L'$ ($L' \in \mathcal{F}'$) defines a family of C^∞ simple curves $\{\ell_\lambda^{(x)}\}_{\lambda \in \Lambda(x)}$ of $A^{(x)}$, where we understand that $\ell_\lambda^{(x)}$ is a closed set of $A^{(x)}$ and $\ell_\lambda^{(x)} \cap \text{Int } A^{(x)}$ is connected. We note that there exists a C^∞ vector field on the manifold (with corner) obtained by cutting $S^1 \times D^2$ at $\{x_0\} \times D^2$ such that integral curves are $\bigcup_x \{\ell_\lambda^{(x)}\}_{\lambda \in \Lambda(x)}$.

- Lemma 1.* — (i) $\ell_\lambda^{(x)}$ is tangent to $\partial A^{(x)}$ at (x, y) if and only if $y \in \partial A^{(x)} \cap \widehat{\Sigma}^{(-)}$, $y \in \ell_\lambda^{(x)}$.
 (ii) $\ell_\lambda^{(x)}$ is reduced to a point at $(x, y) \in \partial A^{(x)} \cap \widehat{\Sigma}^{(+)}$.
 (iii) $\{\ell_\lambda^{(x)}\}_{\lambda \in \Lambda(x)}$ forms a family of concentric half circles with (x, y) as center near $(x, y) \in \partial A^{(x)} \cap \widehat{\Sigma}^{(+)}$ and upper part of a family of confocal parabolas with (x, y) as focus near $(x, y) \in \partial A^{(x)} \cap \widehat{\Sigma}^{(-)}$ (Fig. 4 and 5).

This lemma is clear, because the situation of $\{\ell_\lambda^{(x)}\}_{\lambda \in \Lambda}$ near $(x, y) \in \partial A^{(x)} \cap \widehat{\Sigma}^{(+)}$ (resp. $(x, y) \in \partial A^{(x)} \cap \widehat{\Sigma}^{(-)}$) is similar as the situation of leaves of the plus (resp. minus) Reeb component $\overline{\mathcal{F}}_R^{(+)}$ (resp. $\overline{\mathcal{F}}_R^{(-)}$) near a point of $\widehat{\Sigma}^{(+)}$ (resp. $\widehat{\Sigma}^{(-)}$).

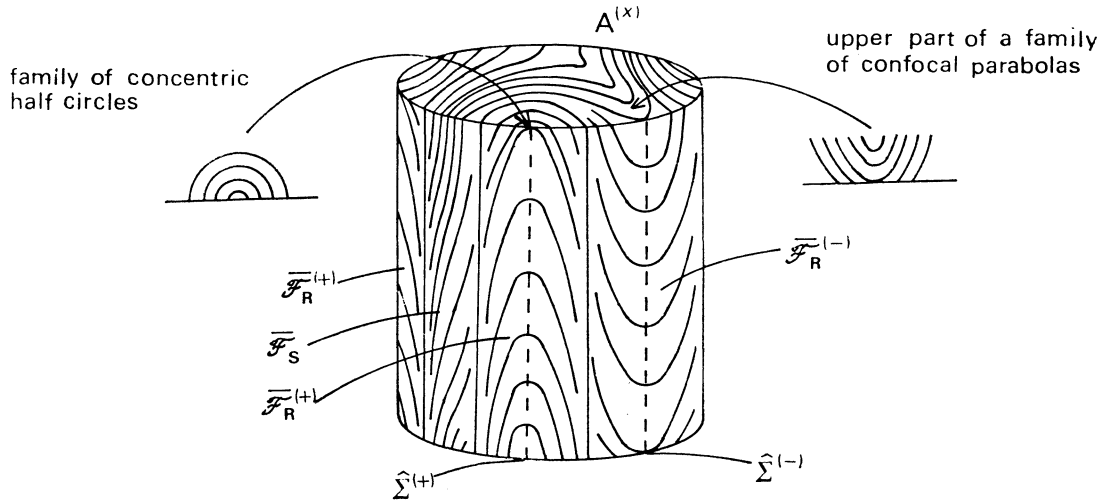

FIG. 5

For $y \in \partial D^2$, let $\ell^{(x)}(y)$ denote a simple curve of $\{\ell_\lambda^{(x)}\}_{\lambda \in \Lambda(x)}$ containing (x, y) . If $(x, y) \notin \widehat{\Sigma}^{(+)} \cup \widehat{\Sigma}^{(-)}$, $\ell^{(x)}(y)$ exists and is unique, and if $(x, y) \in \widehat{\Sigma}^{(-)}$ there exist two kinds of $\ell^{(x)}(y)$, say $\ell_1^{(x)}(y)$ and $\ell_2^{(x)}(y)$. The following lemma is an immediate consequence of the Poincaré-Bendixson theorem:

Lemma 2. — For $(x, y) \notin \widehat{\Sigma}^{(+)}$, the simple curve $\ell^{(2)}(y)$ (resp. $\ell_1^{(2)}(y)$) ($i = 1, 2$) intersects $\partial A^{(2)}$ at exactly two points.

We denote by $[\ell^{(2)}(y)]$ the intersection point different from (x, y) .

Let $X = \{X(z); z \in A\}$ be a C^∞ vector field on $A = S^1 \times D^2$ satisfying the following conditions:

- (i) $X(z) \neq 0$ if $z \in A - (\widehat{\Sigma}^{(+)} \cup \widehat{\Sigma}^{(-)})$; $X(z) = 0$ if $z \in \widehat{\Sigma}^{(+)} \cup \widehat{\Sigma}^{(-)}$.
- (ii) $X(z)$ ($z \notin \widehat{\Sigma}^{(+)} \cup \widehat{\Sigma}^{(-)}$, $z = (x, y) \in S^1 \times D^2$) is transverse to $A^{(2)} = \{x\} \times D^2$ and lies in the positive direction of S^1 .
- (iii) X is tangent to \mathcal{F}' and hyperbolic at each point of $\widehat{\Sigma}^{(-)}$.
- (iv) $X|_{\partial A}$ is tangent to $\partial A = S^1 \times \partial D^2$.

The existence of such a C^∞ vector field X is obvious.

Let $\tilde{\pi}: \mathbf{R} \times D^2 \rightarrow S^1 \times D^2$ denote the covering map such that $\tilde{\pi}^{-1}(\{*\} \times D^2) = \mathbf{Z} \times D^2$ and $\tilde{\pi}|_{(\mathbf{R} \times \{**\})}: \mathbf{R} \rightarrow S^1$ is orientation-preserving with respect to the natural orientation of \mathbf{R} . Let $\tilde{X} = \{\tilde{X}(\tilde{z}); \tilde{z} \in \mathbf{R} \times D^2\}$ be the C^∞ vector field on $\mathbf{R} \times D^2$ such that $\tilde{\pi}_* (\tilde{X}(\tilde{z})) = X(\tilde{\pi}(\tilde{z}))$, and $\tilde{\varphi}(t, \tilde{z})$ denote the integral curve of \tilde{X} with the initial condition $\tilde{\varphi}(0, \tilde{z}) = \tilde{z}$ (for $\tilde{z} \in \mathbf{R} \times D^2$).

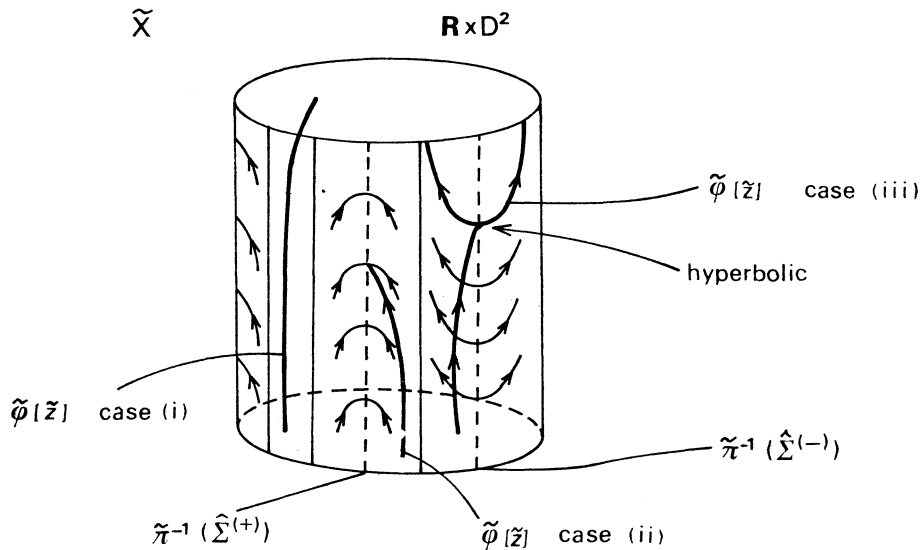

FIG. 6

For $\tilde{z} \in \mathbf{R} \times D^2 - \tilde{\pi}^{-1}(\widehat{\Sigma}^{(+)} \cup \widehat{\Sigma}^{(-)})$, we define a subset $\tilde{\varphi}[\tilde{z}]$ of $\mathbf{R} \times D^2$ as follows (Fig. 6):

- (i) if $\tilde{\varphi}(t, \tilde{z})$ does not approach to a point of $\tilde{\pi}^{-1}(\widehat{\Sigma}^{(+)} \cup \widehat{\Sigma}^{(-)})$ for $t \geq 0$, we define $\tilde{\varphi}[\tilde{z}] = \{\tilde{\varphi}(t, \tilde{z}); 0 \leq t < \infty\}$;

(ii) if $\tilde{\varphi}(t, \tilde{z})$ approaches to a point of $\tilde{\pi}^{-1}(\hat{\Sigma}^{(+)})$ for $t \geq 0$, we define

$$\tilde{\varphi}[\tilde{z}] = \{\tilde{\varphi}(t, \tilde{z}); 0 \leq t < \infty\} \cup \{\lim_{t \rightarrow \infty} \tilde{\varphi}(t, \tilde{z})\};$$

(iii) if $\tilde{\varphi}(t, \tilde{z})$ approaches to a point of $\pi^{-1}(\hat{\Sigma}^{(-)})$ for $t \geq 0$, we define

$$\tilde{\varphi}[\tilde{z}] = \{\tilde{\varphi}(t, \tilde{z}); 0 \leq t < \infty\} \cup \{\lim_{t \rightarrow \infty} \tilde{\varphi}(t, \tilde{z})\} \cup \{\tilde{z}'; \lim_{t \rightarrow -\infty} \tilde{\varphi}(t, \tilde{z}') = \lim_{t \rightarrow \infty} \tilde{\varphi}(t, \tilde{z})\}.$$

For $s \geq 0, z \in A = S^1 \times D^2$, we define a subset $\Phi_s(z)$ of A (possibly $\Phi_s(z) = \emptyset$) by

$$\Phi_s(z) = \tilde{\pi}((\tilde{\varphi}[\tilde{z}]) \cap (\{\tilde{x} + s\} \times D^2)),$$

where $\tilde{\pi}(\tilde{z}) = z$ and $\tilde{z} \in \{\tilde{x}\} \times D^2$. $\Phi_s(z)$ consists of one or two points unless $\Phi_s(z) = \emptyset$.

If $\Phi_s(z) \subset \hat{\Sigma}^{(+)}$ for $z \in \ell^{(x)}(y)$, then, by Lemma 1, (iii), we have

$$\Phi_s(x, y) = \Phi_s([\ell^{(x)}(y)]) = \Phi_s(z) \quad (s > 0),$$

which implies that y and $[\ell^{(x)}(y)]$ belong to the interior of the same plus Reeb component. Thus, if one of the points $\ell_\lambda^{(x)} \cap \partial A^{(x)}$ is not contained in the interior of a plus Reeb component in $\bar{\mathcal{F}}''$, then we have

$$\Phi_s(z) \cap \hat{\Sigma}^{(+)} = \emptyset \quad (z \in \ell_\lambda^{(x)}, s \geq 0),$$

that is, $\Phi_s(z) \neq \emptyset$ for $z \in \ell_\lambda^{(x)}, s \geq 0$.

The image $\bigcup_{z \in \ell_\lambda^{(x)}} \Phi_s(z)$ of $\ell_\lambda^{(x)}$ with respect to Φ_s bifurcates at $\Phi_{s'}(z)$ if and only if $\Phi_{s'}(z) \subset A^{(\tilde{\pi}(\tilde{x} + s'))} \cap \hat{\Sigma}^{(-)}$ (Fig. 7). Thus, in general, the image of $\ell_\lambda^{(x)}$ with respect to Φ_s consists of a finite number of simple curves of $\{\ell_\lambda^{(\tilde{\pi}(\tilde{x} + s))}\}_{\lambda \in \Lambda(\tilde{\pi}(\tilde{x} + s))}$, because the number of values $s' \in [0, s]$ at which $\Phi_{s'}$ bifurcates are finite (Fig. 7).

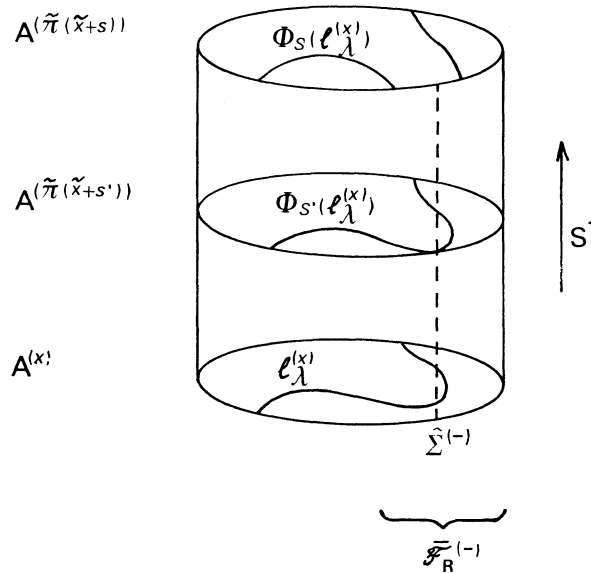

FIG. 7

Lemma 3. — Let \hat{L} be a compact leaf of $\overline{\mathcal{F}}''$ of ∂A and let $(x, \hat{y}) \in \hat{L} \cap \partial A^{(x)}$, then $[\ell^{(x)}(\hat{y})]$ is an intersection point of a compact leaf of $\overline{\mathcal{F}}''$ and $\partial A^{(x)}$.

Proof. — Let us consider the case where the longitudinal number a of $\overline{\mathcal{F}}''$ is 1. Thus $\{\ell_\lambda^{(x)}\}_{\lambda \in \Lambda(x)}$ is a family of integral curves of a C^∞ vector field on A .

First assume that the image of $\ell^{(x)}(\hat{y})$ with respect to Φ_s does not bifurcate for $0 \leq s \leq 1$. Then $\Phi_s(z)$ moves continuously for $0 \leq s \leq 1$, $z \in \ell^{(x)}(\hat{y})$. Since \hat{y} is a point of a compact leaf \hat{L} , we have $\Phi_1(x, \hat{y}) = \{(x, \hat{y})\}$. Thus, by the uniqueness of $\ell^{(x)}(\hat{y})$, the image of $\ell^{(x)}(\hat{y})$ with respect to Φ_1 agrees with itself:

$$\Phi_1([\ell^{(x)}(\hat{y})]) = \{[\ell^{(x)}(\hat{y})]\}.$$

This shows that $[\ell^{(x)}(\hat{y})]$ is contained in a compact leaf of $\overline{\mathcal{F}}''$.

Suppose that the image of $\ell^{(x)}(\hat{y})$ with respect to Φ_s bifurcates at a finite number of values of $0 \leq s \leq 1$, and the image of $\ell^{(x)}(\hat{y})$ with respect to Φ_1 is given by

$$\ell^{(x)}(\hat{y}_0) \cup \ell^{(x)}(\hat{y}_1) \cup \dots \cup \ell^{(x)}(\hat{y}_m),$$

where $\hat{y}_0 = \hat{y}$ and $\ell^{(x)}(\hat{y}_i)$ ($i = 0, 1, \dots, m$) are simple curves in $\{\ell_\lambda^{(x)}\}_{\lambda \in \Lambda(x)}$ such that $[\ell^{(x)}(\hat{y}_i)]$ and (x, \hat{y}_{i+1}) belong to the interior of the same minus Reeb component in $\overline{\mathcal{F}}''$ ($i = 0, 1, \dots, m-1$) (Fig. 7). Assume that $m \geq 1$. Then, $[\ell^{(x)}(\hat{y})] = [\ell^{(x)}(\hat{y}_0)]$ should belong to the interior of a minus Reeb component in $\overline{\mathcal{F}}''$. However, according to properties of the minus Reeb component, it is easy to see that $\{[\ell^{(x)}(\hat{y}_m)]\} = \Phi_1([\ell^{(x)}(\hat{y})])$ and $[\ell^{(x)}(\hat{y}_1)]$ belong to different connected components of $A^{(x)} - \ell^{(x)}(\hat{y}_0)$. On the other hand, $[\ell^{(x)}(\hat{y}_1)]$ and $[\ell^{(x)}(\hat{y}_m)]$ should be connected by a connected continuous curve in $A^{(x)}$ oriented by the following order

$$\bar{\ell}_1 \cup \ell^{(x)}(\hat{y}_2) \cup \bar{\ell}_2 \cup \ell^{(x)}(\hat{y}_3) \cup \dots \cup \bar{\ell}_{m-1} \cup \ell^{(x)}(\hat{y}_m)$$

such that $\bar{\ell}_i$ is contained in the interior of a minus Reeb component ($i = 1, 2, \dots, m-1$), and that, if $\bar{\ell}_i$ is contained in the minus Reeb component to which $\ell^{(x)}(\hat{y}_m)$ belongs, the orientation of $\bar{\ell}_i$ is consistent to $\overrightarrow{[\ell^{(x)}(\hat{y}_0)](x, \hat{y}_1)}$. This is a contradiction. Therefore $\ell^{(x)}(\hat{y})$ does not bifurcate for $0 \leq s \leq 1$. Thus this lemma is proved in case $a = 1$.

In case $a = 2$, the same arguments hold by considering the double covering of $A = S^1 \times D^2$. Thus Lemma 3 is proved. (See also [9; p. 61].)

Lemma 4. — Let \hat{L} be a compact leaf of $\overline{\mathcal{F}}''$ of $\partial A = S^1 \times \partial D^2$ and let L be the leaf of \mathcal{F}' containing \hat{L} . Then $L \cap A$ is compact, and it is an annulus in case $a = 1$ and is an annulus or a Möbius band in case $a = 2$, where a is the longitudinal number of $\overline{\mathcal{F}}''$. $L \cap A^{(x)}$ consists of a simple arc in case $a = 1$ and of one or two simple arcs in case $a = 2$.

Proof. — According to Lemma 3, it is easy to see that there exists a diffeomorphism from $\hat{L} \times I$ or Möbius band $\hat{L} \times I / \mathbf{Z}_2$ to $L \cap A$.

Lemma 5. — Let $\overline{\mathcal{F}}_R^{(+)}$ be a plus Reeb component in $\overline{\mathcal{F}}''$ of $\partial A = S^1 \times \partial D^2$ and let $|\overline{\mathcal{F}}_R^{(+)}|$ denote the underlying submanifold of $\overline{\mathcal{F}}_R^{(+)}$ in ∂A . Denote by \hat{L}, \hat{L}' the compact leaves of

$\overline{\mathcal{F}}_R^{(+)}: \partial|\overline{\mathcal{F}}_R^{(+)}| = \widehat{L} \cup \widehat{L}'$, where it may happen that $\widehat{L} = \widehat{L}'$ in case the longitudinal number of $\overline{\mathcal{F}}''$ is 2. Then, for $\{c\} \in \widehat{L} \cap \partial A^{(x)}$, we have

$$[\ell^{(x)}(c)] \in \widehat{L}' \cap \partial A^{(x)}.$$

Proof. — Let $\sigma \in |\overline{\mathcal{F}}_R^{(+)}| \cap \partial A^{(x)} \cap \widehat{\Sigma}^{(+)}$. We denote $\widehat{L}' \cap \partial A^{(x)}$ by c' . We fix an orientation on $\partial A^{(x)}$ so that the oriented arcs $\widehat{c'\sigma}$, $\widehat{\sigma c}$ have the orientation compatible with that of $\partial A^{(x)}$, where $\widehat{c'\sigma} \cap \widehat{\sigma c} = \{\sigma\}$ (Fig. 8).

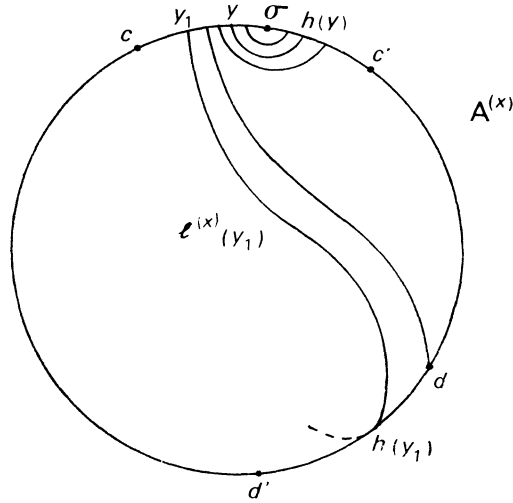

FIG. 8

Let $h: \widehat{\sigma c} \rightarrow \partial A^{(x)}$ be the map (not necessary continuous) defined by

$$h(y) = [\ell^{(x)}(y)] \quad (y \in \widehat{\sigma c}).$$

Then, by Lemma 1, (iii), there exists a neighborhood U_0 of σ in $\partial A^{(x)}$ such that h is continuous on $U_0 \cap \text{Int } \widehat{\sigma c}$.

Assume that there exists a point $y_1 \in \widehat{\sigma c}$ such that h is continuous on $\widehat{\sigma y_1} - \{y_1\}$ and is not continuous at y_1 . This is equivalent to that $\ell^{(x)}(y)$ intersects $\partial A^{(x)}$ transversely at $h(y) = [\ell^{(x)}(y)]$ for $y \in \widehat{\sigma y_1} - \{y_1\}$ and $\ell^{(x)}(y_1)$ is tangent to $\partial A^{(x)}$ at $h(y_1) = [\ell^{(x)}(y_1)]$ (Fig. 8, 9). Thus we have $h(y_1) \in \widehat{\Sigma}^{(-)}$.

Denote by $\overline{\mathcal{F}}_R^{(-)}$ the minus Reeb component such that $h(y_1) \in |\overline{\mathcal{F}}_R^{(-)}|$, where $|\overline{\mathcal{F}}_R^{(-)}|$ is the underlying submanifold of $\overline{\mathcal{F}}_R^{(-)}$. Let d, d' denote the boundary points $\partial(|\overline{\mathcal{F}}_R^{(-)}| \cap A^{(x)})$ such that oriented arcs $\widehat{d'h(y_1)}$, $\widehat{h(y_1)d}$ contained in $|\overline{\mathcal{F}}_R^{(-)}| \cap A^{(x)}$ have the orientation compatible with that of $\partial A^{(x)}$ (Fig. 8).

Suppose that $\ell^{(x)}(y_1)$ is tangent to $\partial A^{(x)}$ at $h(y_1)$ in the inverse direction of $\partial A^{(x)}$, then, it is easy to see that

$$h|_{\widehat{\sigma y_1}}: \widehat{\sigma y_1} \rightarrow \widehat{h(y_1)\sigma}$$

is an onto homeomorphism (Fig. 8). Thus $h^{-1}(d)$ exists in $\widehat{\text{Int}} \sigma y_1$ which should be contained in a compact leaf of $\overline{\mathcal{F}}''$ by Lemma 3. This is a contradiction. Therefore $\ell^{(x)}(y_1)$ is tangent to $\partial A^{(x)}$ at $h(y_1)$ in the direction of $\partial A^{(x)}$ (Fig. 9).

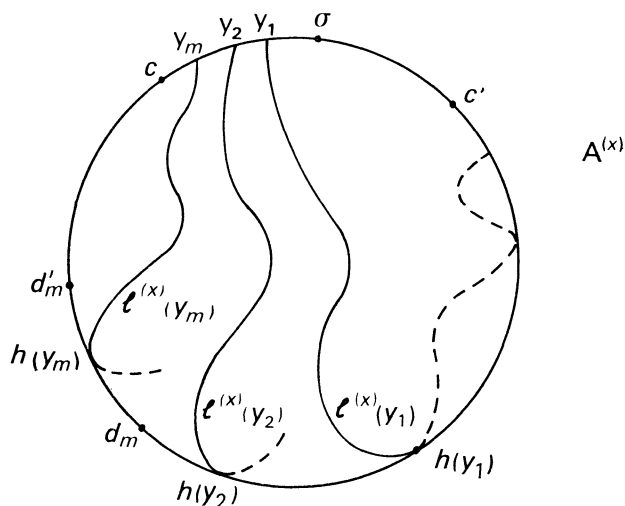

FIG. 9

Thus there exists a neighborhood U_1 of y_1 in $\partial A^{(x)}$ such that h is continuous on $U_1 \cap \widehat{\text{Int}} y_1 c$. If h is not continuous at a point of $\widehat{y_1 c}$, then there exists $y_2 \in \widehat{\text{Int}} y_1 c$ such that h is continuous on $\widehat{\text{Int}} y_1 y_2$ and is not continuous at y_2 . By the same argument used above, $\ell^{(x)}(y_2)$ is tangent to $\partial A^{(x)}$ at $h(y_2)$ in the direction of $\partial A^{(x)}$ (Fig. 9).

Since the number of minus Reeb components is finite, by repeating this process, there are a finite number of points y_1, y_2, \dots, y_m of $\widehat{\text{Int}} \sigma c$ situated in this order such that h is continuous on $\widehat{\sigma c} - \{\sigma\} - \bigcup_{i=1}^m y_i$ and discontinuous at y_i ($i=1, 2, \dots, m$) and that $\ell^{(x)}(y_i)$ is tangent to $\partial A^{(x)}$ at $h(y_i) \in \widehat{\Sigma}^{(-)}$ in the direction of $\partial A^{(x)}$ (Fig. 9). Suppose that $h(y_m)$ is contained in a minus Reeb component $'\overline{\mathcal{F}}_R^{(-)}$ and let $d'_m d_m$ be the arc $|\overline{\mathcal{F}}_R^{(-)}| \cap A^{(x)}$ having the orientation compatible with that of $\partial A^{(x)}$:

$$h(y_m) \in \widehat{d'_m d_m}.$$

Then h maps $\widehat{y_m c}$ into $\widehat{ch(y_m) - \{c\}}$. If $h(\widehat{y_m c}) \subset \widehat{d'_m h(y_m) - \{d'_m\}}$, then $\widehat{d'_m h(y_m) - \{d'_m\}}$ must contain the point $h(c)$ of a compact leaf of $\overline{\mathcal{F}}''$ by Lemma 3. This is a contradiction. Further, if $h(\widehat{\text{Int}} y_m c) \supset \widehat{d'_m h(y_m)}$, then $\widehat{\text{Int}} y_m c$ must contain the point $h^{-1}(d'_m)$ of a compact leaf of $\overline{\mathcal{F}}''$ by Lemma 3. This is also a contradiction. Thus $h(c) = d'_m$ holds. This implies that c and d'_m lie on a compact leaf L of \mathcal{F}' by Lemma 4.

However, since c is a point of a compact leaf of the boundary of a plus Reeb

component, L has a contracting holonomy in the negative direction of S^1 in this side, and, on the other hand, since d'_m is a point of a compact leaf of the boundary of a minus Reeb component, L has a contracting holonomy in the direction of S^1 in the same side. This is a contradiction. Therefore there exists no discontinuous point of h on $\widehat{\sigma c}$ and

$$h|(\widehat{\sigma c} - \{\sigma\}) : \widehat{\sigma c} - \{\sigma\} \rightarrow \widehat{h(c)\sigma} - \{\sigma\}$$

is a C^∞ diffeomorphism. The point $h(c)$ must belong to a compact leaf of $\overline{\mathcal{F}}''$ by Lemma 3. Thus, making use of the same argument as above, we have

$$h(c) = c'.$$

This completes the proof of Lemma 5.

Proposition 3. — (i) Let \widehat{L} be a compact leaf of $\overline{\mathcal{F}}'$ of $\partial(S^1 \times D^2)$ and let L be the leaf of \mathcal{F}' containing \widehat{L} . Then L is compact and an annulus in case $a=1$ and an annulus or a Möbius band in case $a=2$ such that $\partial L = L \cap \partial(S^1 \times D^2)$ consists of two compact leaves of $\overline{\mathcal{F}}'$ in case $a=1$ and of one or two compact leaves of $\overline{\mathcal{F}}'$ in case $a=2$, where a is the longitudinal number of $\overline{\mathcal{F}}'$.

(ii) For a plus Reeb component $\overline{\mathcal{F}}_R^{(+)}$ in $\overline{\mathcal{F}}'$, there exists a plus half Reeb component $\mathcal{F}_{R/2}^{(+)}$ in \mathcal{F}' such that $\overline{\mathcal{F}}_R^{(+)}$ is the restriction of $\mathcal{F}_{R/2}^{(+)}$ to $|\overline{\mathcal{F}}_R^{(+)}|$, where it may happen that the compact leaf of $\mathcal{F}_{R/2}^{(+)}$ forms a Möbius band in $\overline{\mathcal{F}}'$ identified by a free \mathbf{Z}_2 action in case $a=2$. Let $A = \bigcup_x A^{(x)}$ be as in Section 2, then $\{A^{(x)} \cap L'; L' \in \mathcal{F}_{R/2}^{(+)}\}$ consists of concentric half circles.

Proof. — There is a natural isomorphism from $\overline{\mathcal{F}}'$ to $\overline{\mathcal{F}}''$ of ∂A and the compact leaves corresponding by this isomorphism are the boundary of an annulus which is the restriction of a leaf of \mathcal{F}' to $S^1 \times D^2 - \text{Int } A$. Thus the first part of (i) is an immediate consequence of Lemma 4. For a compact leaf \widehat{L} of the boundary of $|\overline{\mathcal{F}}_R^{(+)}|$, there exists a compact leaf L containing \widehat{L} as above. According to Lemma 5, ∂L consists of the two compact leaves of $\overline{\mathcal{F}}_R^{(+)}$ in case $a=1$ and of one or two compact leaves in case $a=2$. Thus the second part of (i) is proved.

Now we prove (ii). Let L be the compact leaf of \mathcal{F}' containing a compact leaf of $\partial|\overline{\mathcal{F}}_R^{(+)}|$. Assume L is annular. Let R denote the closure of a connected component of $S^1 \times D^2 - L$ which contains $\text{Int}|\overline{\mathcal{F}}_R^{(+)}|$. Since, as was shown in the proof of Lemma 5, $R \cap A^{(x)}$ consists of concentric half circles, $\mathcal{F}'|R$ is a plus half Reeb component. Thus Proposition 3 is proved. In case L is a Möbius band, the same arguments hold by considering the double covering of $S^1 \times D^2$.

4. TS components

First we prove the following lemma.

Lemma 6. — Let \widehat{L} be a compact leaf of $\overline{\mathcal{F}}'$ which is a boundary of a minus Reeb component $\overline{\mathcal{F}}_R^{(-)}$ or a slope component $\overline{\mathcal{F}}_S$ and let L be the compact leaf of \mathcal{F}' containing \widehat{L} (Propo-

sition 3, (i)). Let B denote the closure of a connected component of $S^1 \times \partial D^2 - \partial L$ which contains $\text{Int}|\overline{\mathcal{F}}_R^{(-)}|$ or $\text{Int}|\overline{\mathcal{F}}_S|$, where $|\overline{\mathcal{F}}_R^{(-)}|$, $|\overline{\mathcal{F}}_S|$ denote underlying submanifolds. Then $\hat{L}' = \partial L - \hat{L}$ is a compact leaf of \mathcal{F}' which is a boundary of a minus Reeb component or a slope component contained in B , unless $\partial L = \hat{L}$.

Proof. — First assume that the longitudinal number a is 1. Suppose that there exists a family of compact leaves $\{\hat{L}'_i\}$ of $\mathcal{F}'|B$ which accumulates to \hat{L}' . Then, by Proposition 3, (i), we have a family of compact leaves $\{L_i\}$ of \mathcal{F}' such that

$$\partial L_i = \hat{L}_i \cup \hat{L}'_i = L_i \cap (S^1 \times \partial D^2).$$

Thus $\{\hat{L}_i\}$ accumulates to \hat{L} which contradicts the assumption on \hat{L} . Thus \hat{L}' is a boundary of a plus or minus Reeb component, or of a slope component. But \hat{L}' cannot be a boundary of a plus Reeb component by Proposition 3, (ii). In case $a = 2$, the same arguments hold by considering the double covering of $S^1 \times D^2$. Note that it may happen that $\partial L = \hat{L}$ in this case. Thus this lemma is proved.

In the following $\overline{\mathcal{F}}_i$ denotes a minus Reeb component or a slope component contained in \mathcal{F}' . $\overline{\mathcal{F}}_1$ and $\overline{\mathcal{F}}_2$ are called to be *connected by a compact leaf* L , denoted by $\overline{\mathcal{F}}_1 \underset{L}{\sim} \overline{\mathcal{F}}_2$, if there exists a compact annular leaf (resp. a Möbius band in case $a = 2$) L of \mathcal{F}' with $\partial L = \bar{L} \cup \bar{L}'$ (resp. $\partial L = \bar{L}$) such that $\bar{L} \subset |\overline{\mathcal{F}}_1|$, $\bar{L}' \subset |\overline{\mathcal{F}}_2|$ (resp. $\bar{L} \subset |\overline{\mathcal{F}}_1|$, $\bar{L} \subset |\overline{\mathcal{F}}_2|$) and that $\text{Int}|\overline{\mathcal{F}}_1|$ and $\text{Int}|\overline{\mathcal{F}}_2|$ are contained in the same connected component of $S^1 \times \partial D^2 - \bar{L} - \bar{L}'$ (resp. $S^1 \times \partial D^2 - \bar{L}$) (Fig. 10).

Further, $\overline{\mathcal{F}}_0$ and $\overline{\mathcal{F}}_m$ are called to be *connected* if there exists a sequence $\overline{\mathcal{F}}_1, \overline{\mathcal{F}}_2, \dots, \overline{\mathcal{F}}_{m-1}$ such that

$$\overline{\mathcal{F}}_i \underset{L_i}{\sim} \overline{\mathcal{F}}_{i+1} \quad (i = 0, 1, \dots, m-1)$$

for some compact leaves L_i ($i = 0, 1, \dots, m-1$) of \mathcal{F}' .

By Lemma 6, q copies of the minus Reeb components in $\overline{\mathcal{F}'}$ are divided into connected components.

Lemma 7. — Let $\mathcal{C} = \{\overline{\mathcal{F}}_j^{(-)}; j = 1, 2, \dots, m\}$ be a connected component of q copies of the minus Reeb component in $\overline{\mathcal{F}'}$. Then there exist two slope components $\overline{\mathcal{F}}_S^{(1)}, \overline{\mathcal{F}}_S^{(2)}$ in $\overline{\mathcal{F}}^{(1)}$ such that $\{\overline{\mathcal{F}}_j^{(-)}; j = 1, 2, \dots, m\} \cup \{\overline{\mathcal{F}}_S^{(1)}, \overline{\mathcal{F}}_S^{(2)}\}$ is a connected component of the set of q copies of the minus Reeb component and slope components in $\overline{\mathcal{F}'}$. Further, $\overline{\mathcal{F}}_S^{(1)}$ and $\overline{\mathcal{F}}_S^{(2)}$ are connected by a compact leaf.

Proof. — First we assume that the longitudinal number a is 1. Let

$$\{\overline{\mathcal{F}}_j^{(-)}; j = 1, 2, \dots, m, m+1, \dots, m'\} \cup \{\overline{\mathcal{F}}_S^{(\delta)}; \delta \in \Delta\}$$

be a connected component of the set of q copies of the minus Reeb component and slope components in $\overline{\mathcal{F}'}$ containing \mathcal{C} . Let L be an arbitrary compact leaf of \mathcal{F}' , then

$L \cap A^{(x)}$ is a simple curve in $A^{(x)}$ and $L \cap A^{(x)}$ divides $A^{(x)}$ into two connected components, say $A_1^{(x)}$ and $A_2^{(x)}$. Since the Euler number $\chi(A_i^{(x)})$ is equal to 1 ($i = 1, 2$), we have

$$A_i^{(x)} \cap \widehat{\Sigma}^{(+)} \neq \emptyset \quad (i = 1, 2).$$

Since $\overline{\mathcal{F}'}$ contains only a finite number of plus Reeb components, this observation shows that Δ is a finite set, say $\Delta = \{\delta_i; i = 1, 2, \dots, r\}$.

Let L_k ($k = 0, 1, \dots, r + m' - 1$) be compact leaves which connect

$$\{\overline{\mathcal{F}}_j^{(-)}; j = 1, 2, \dots, m'\} \cup \{\overline{\mathcal{F}}_s^{(\delta_i)}; i = 1, 2, \dots, r\}$$

and let $Q^{(x)}$ denote the closure of a connected component of $A^{(x)} - \bigcup_{k=0}^{r+m'-1} L_k$ intersecting $\text{Int} |\overline{\mathcal{F}}_j^{(-)}|$ and $\text{Int} |\overline{\mathcal{F}}_s^{(\delta_i)}|$. Denote by $\widehat{Q}^{(x)}$ the double of $Q^{(x)}$ obtained by pasting $Q^{(x)} \cap \partial A^{(x)}$. Then the Euler number $\chi(\widehat{Q}^{(x)})$ is equal to $2 - (m' + r)$. On the other hand, a C^∞ vector field on $\widehat{Q}^{(x)}$ introduced naturally by $\{\ell_\lambda^{(x)}\}_{\lambda \in \Lambda^{(x)}}$ is tangent to $\partial \widehat{Q}^{(x)}$ and has exactly m' singular points of index -1 . Thus we have $r = 2$.

Further compact leaves having contracting holonomy in the negative direction of S^1 are only contained in $\overline{\mathcal{F}}_s^{(\delta_1)}$ and $\overline{\mathcal{F}}_s^{(\delta_2)}$. In order to be connected by a compact leaf, compact leaves in $\overline{\mathcal{F}}_j^{(-)}$ or in $\overline{\mathcal{F}}_s^{(\delta_i)}$ should have the same holonomy. Therefore $\overline{\mathcal{F}}_s^{(\delta_1)}$ and $\overline{\mathcal{F}}_s^{(\delta_2)}$ should be connected by a compact leaf which implies that $m = m'$.

In case $a = 2$, the same arguments hold by considering the double covering of $S^1 \times D^2$. Thus this lemma is proved.

Let \mathcal{C} be as in Lemma 7, then, by Lemma 7, there exists slope components $\overline{\mathcal{F}}_s^{(1)}$, $\overline{\mathcal{F}}_s^{(2)}$ and compact leaves L_k ($k = 0, 1, 2, \dots, m + 1$) of \mathcal{F}' such that

$$\begin{aligned} \overline{\mathcal{F}}_s^{(1)} &\underbrace{\quad}_{L_1} \overline{\mathcal{F}}_1^{(-)}, & \overline{\mathcal{F}}_i^{(-)} &\underbrace{\quad}_{L_{i+1}} \overline{\mathcal{F}}_{i+1}^{(-)} & (i = 1, 2, \dots, m-1), \\ \overline{\mathcal{F}}_m^{(-)} &\underbrace{\quad}_{L_{m+1}} \overline{\mathcal{F}}_s^{(2)}, & \overline{\mathcal{F}}_s^{(2)} &\underbrace{\quad}_{L_0} \overline{\mathcal{F}}_s^{(1)}. \end{aligned}$$

Let $Q(\mathcal{C})$ or simply Q denote the closure of a connected component of $S^1 \times D^2 - \bigcup_{i=0}^{m+1} L_i$ containing $\text{Int} |\overline{\mathcal{F}}_j^{(-)}|$ ($j = 1, 2, \dots, m$). The C^∞ foliation $\mathcal{F}'|_Q$ of codimension one which is the restriction of \mathcal{F}' to $Q(\mathcal{C})$ is called a *TS component of type m* with respect to \mathcal{C} and denoted by TS_m . We denote by $|\text{TS}_m|$ the underlying submanifold Q of TS_m .

Proposition 4. — *There exists a C^∞ foliation \mathcal{F}' of codimension one of $S^1 \times D^2$ transverse to the plus Reeb component such that \mathcal{F}' contains a TS component of type m .*

Proof. — Figure 5 and Figure 10 show the existence of a TS component of type 1. Similar a TS component of type m exists for any $m \geq 1$.

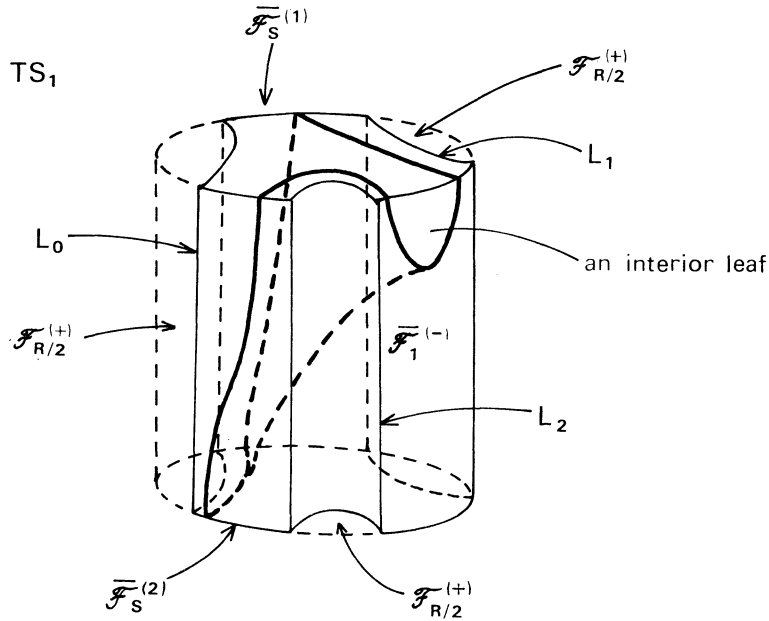

FIG. 10

The following proposition is an immediate consequence of Lemma 7.

Proposition 5. — For a minus Reeb component $\overline{\mathcal{F}}_R^{(-)}$ in $\overline{\mathcal{F}}'$, there exists a TS component TS_m of type m such that $|\text{TS}_m| \supset |\overline{\mathcal{F}}_R^{(-)}|$.

Proposition 6. — The TS component TS_m of type m with respect to

$$\mathcal{C} = \{\overline{\mathcal{F}}_j^{(-)}; j = 1, 2, \dots, m\}$$

has the following properties:

(i) The underlying submanifold $|\text{TS}_m|$ of $S^1 \times D^2$ is a compact connected 3-dimensional C^∞ manifold with corner, where the corner consists of the boundaries of compact leaves L_k ($k = 0, 1, \dots, m + 1$) and is C^∞ diffeomorphic to $S^1 \times D^2$ by straightening the corner. The set $|\text{TS}_m| \cap (S^1 \times \partial D^2)$ consists of minus Reeb components $\overline{\mathcal{F}}_j^{(-)}$ ($j = 1, 2, \dots, m$) and slope components $\overline{\mathcal{F}}_S^{(i)}$ ($i = 1, 2$).

(ii) The intersection $|\text{TS}_m| \cap (\{x\} \times D^2)$ ($x \in S^1$) is a polygon with $2(m + 2)$ vertices (resp. a polygon with $4m + 4$ vertices or two disjoint polygons with $2(m + 2)$ vertices) if the longitudinal number a is 1 (resp. 2).

(iii) The compact leaves in TS_m are exactly L_k ($k = 0, 1, \dots, m + 1$). They are annular in case $a = 1$ and one of them may be a Möbius band in case $|\text{TS}_m| \cap (\{x\} \times D^2)$ is a polygon with $4m + 4$ vertices. The compact leaf L_k has a contracting holonomy in the positive (resp. negative) direction of S^1 if $k = 1, 2, \dots, m + 1$ (resp. $k = 0$).

(iv) Every non-compact leaf L of TS_m meets $\text{Int} |\overline{\mathcal{F}}_j^{(-)}|$ ($j = 1, 2, \dots, m$) and $\text{Int} |\overline{\mathcal{F}}_S^{(1)}|$, $\text{Int} |\overline{\mathcal{F}}_S^{(2)}|$.

(v) Let H denote the subset of \mathbf{R}^2 defined by

$$H = [0, 2m + 1] \times \mathbf{R} \\ - \left\{ (x, y); y - c_k > \frac{1}{(x-k)(k+1-x)}, k < x < k+1, k = 1, 3, \dots, 2m-1 \right\},$$

where c_k is a constant; then every non-compact leaf in TS_m is C^∞ diffeomorphic to H (Fig. 11).

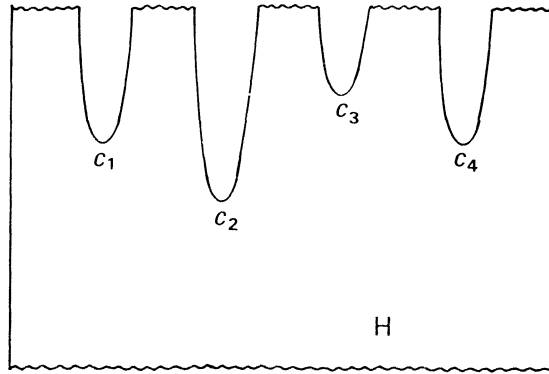

FIG. 11

Proof. — Properties (i), (ii), (iii) are obvious. So we prove (iv), (v) here. A non-compact leaf L of $\mathcal{F}'|Q$ meets $A^{(x)}$ for some $x \in S^1$. Then $L \cap A^{(x)}$ contains a simple curve $\ell_\lambda^{(x)}$ of $\{\ell_\lambda^{(x)}\}_{\lambda \in \Lambda(x)}$. Let (x, y) be an end point of $\ell_\lambda^{(x)}$, then (x, y) belongs to the interior of one of $|\overline{\mathcal{F}}_j^{(-)}|$ ($j = 1, 2, \dots, m$) or $|\overline{\mathcal{F}}_S^{(i)}|$ ($i = 1, 2$) by the identification of ∂A and $S^1 \times \partial D^2$. Assume that $(x, y) \in |\overline{\mathcal{F}}_j^{(-)}|$, then it is easy to see that $L \cap |\overline{\mathcal{F}}_j^{(-)}|$ contains a point (x', y') and (x'', y'') which lie near to L_j and L_{j+1} respectively. Since $\ell^{(x)}(y') \subset L$, $\ell^{(x)}(y'') \subset L$, we have $L \cap |\overline{\mathcal{F}}_{j-1}^{(-)}| \neq \emptyset$, $L \cap |\overline{\mathcal{F}}_{j+1}^{(-)}| \neq \emptyset$. By iterating this process for $|\overline{\mathcal{F}}_j^{(-)}|$ and $|\overline{\mathcal{F}}_S^{(i)}|$, (iv) is proved.

Let \bar{L}' be a non-compact leaf of $\overline{\mathcal{F}}_S^{(1)}$ and let $\bar{L}' \subset L'$ ($L' \in \mathcal{F}'$). For $(x, y) \in \bar{L}'$ ($x \in S^1, y \in \partial D^2$), making use of the identification $S^1 \times D^2 = A$, we consider a simple curve $\ell^{(x)}(y)$ in $A^{(x)}$. If (x, y) is near to L_1 , then $[\ell^{(x)}(y)]$ is a point of $|\overline{\mathcal{F}}_1^{(-)}|$ because $\ell^{(x)}(y)$ lies near to L_1 . Let (x, y_1) denote a point of $|\overline{\mathcal{F}}_1^{(-)}|$ which is symmetric to $[\ell^{(x)}(y)]$ with respect to $\widehat{\Sigma}^{(-)} \cap |\overline{\mathcal{F}}_1^{(-)}|$, then it is obvious that $(x, y_1) \in \bar{L}'$. Thus $\ell^{(x)}(y_1) \subset L'$. Therefore, in general, for a point $(x, y) \in \bar{L}'$, there exists a sequence $\ell^{(x)}(y_0), \ell^{(x)}(y_1), \dots, \ell^{(x)}(y_s)$ of simple curves in $A^{(x)}$ ($s \leq m$) such that

- 1) $(x, y_0) = (x, y) \in |\overline{\mathcal{F}}_S^{(1)}|$, $[\ell^{(x)}(y_s)] \in |\overline{\mathcal{F}}_S^{(2)}|$,
- 2) $\ell^{(x)}(y_k) \subset L'$ ($k = 0, 1, \dots, s$),
- 3) $[\ell^{(x)}(y_k)]$ and (x, y_{k+1}) are points of $|\overline{\mathcal{F}}_{i_k}^{(-)}|$ which are symmetric with respect to $\widehat{\Sigma}^{(-)} \cap |\overline{\mathcal{F}}_{i_k}^{(-)}|$.

Further if (x, y) is sufficiently near to L_0 , then $s=1$ and the above sequence consists of a simple curve $\ell^{(x)}(y)$ such that $[\ell^{(x)}(y)] \in |\overline{\mathcal{F}}_s^{(2)}|$.

By these observations, we can define a C^∞ diffeomorphism f from H onto $L' \cap A$ such that f maps $H \cap ([0, 2m+1] \times \{u\})$ onto $\bigcup_{k=0}^s \ell^{(x)}(y_k)$. Obviously L' is diffeomorphic to H . Thus (v) is proved.

Let TS_m be a TS component of type m with respect to \mathcal{C} as above, $|\widetilde{TS}_m|$ the universal covering of $|TS_m|$ and $\tilde{\pi}: |\widetilde{TS}_m| \rightarrow |TS_m|$ the projection. For the natural projection $p_1: |TS_m| \rightarrow S^1$ which is the restriction of the projection to the first factor $S^1 \times D^2 \rightarrow S^1$, there exist the covering map $\tilde{\pi}'$ and the natural projection \tilde{p} satisfying the following commutative diagram:

$$\begin{array}{ccc} |\widetilde{TS}_m| & \xrightarrow{\tilde{\pi}} & |TS_m| \\ \tilde{p} \downarrow & & \downarrow p_1 \\ \mathbf{R} & \xrightarrow{\tilde{\pi}'} & S^1. \end{array}$$

Denote by $\tilde{\mathcal{F}}'$ the C^∞ foliation of codimension one of $|\widetilde{TS}_m|$ defined by $\{\tilde{\pi}^{-1}(L'); L' \in TS_m\}$. Let $h^{(1)}$ (resp. $h^{(2)}$) be a C^∞ diffeomorphism from the open interval $]0, 1[$ onto a connected component of $\tilde{\pi}^{-1}(\text{Int } |\overline{\mathcal{F}}_s^{(1)}| \cap (\{x\} \times \partial D^2))$ (resp. $\tilde{\pi}^{-1}(\text{Int } |\overline{\mathcal{F}}_s^{(2)}| \cap (\{x\} \times \partial D^2))$), then $\{h^{(1)}(t)\}$ ($0 < t < 1$) is an index set for leaves of $\tilde{\mathcal{F}}' | \tilde{\pi}^{-1}(|\overline{\mathcal{F}}_s^{(1)}|)$. The leaf \tilde{L}_t of $\tilde{\mathcal{F}}'$ containing $h^{(1)}(t)$ intersects $\tilde{\pi}^{-1}(\hat{\Sigma}^{(-)} \cap |\overline{\mathcal{F}}_j^{(-)}|)$ (resp. $\tilde{\pi}^{-1}(|\overline{\mathcal{F}}_s^{(2)}| \cap h^{(2)}(]0, 1[))$) at one point, say $f_j(t)$ (resp. $h^{(2)}(\bar{f}(t))$) for $0 < t < 1$. Then it is easy to see that

$$\begin{aligned} \tilde{p} \circ f_j &:]0, 1[\rightarrow \mathbf{R} \quad (j=1, 2, \dots, m) \\ \bar{f} &:]0, 1[\rightarrow]0, 1[\end{aligned}$$

are C^∞ diffeomorphism. The maps f_j ($j=1, 2, \dots, m$) and \bar{f} are called *lag functions* for TS_m . The lag functions depend on the choice of $\{x\}$ and $h^{(i)}$ ($i=1, 2$).

Now we define a standard TS component of type m . Let P_{2m+4} denote the regular polygon of $2m+4$ vertices and let $\hat{Q}(m)$ be a compact connected orientable 3-dimensional C^∞ manifold with corner obtained from $P_{2m+4} \times I$ by identifying $P_{2m+4} \times \{0\}$ and $P_{2m+4} \times \{1\}$ after twisting of b times, where b is an integer. The boundary $\partial \hat{Q}(m)$ consists of $2m+4$ annuli, say $(S^1 \times I)_i$ ($i=0, 1, \dots, 2m+3$), whose boundaries are corners of $\hat{Q}(m)$.

By the turbulization of $\text{Int } \hat{Q}(m)$ in neighborhoods of $m+1$ annuli $(S^1 \times I)_{2i}$ ($i=1, \dots, m+1$) along $(S^1 \times I)_{2i}$ in the direction of S^1 for $i=1, 2, \dots, m+1$ and in the negative direction of S^1 for $i=0$, a C^∞ foliation $\hat{\mathcal{F}}(m)$ of codimension one of $\hat{Q}(m)$ is constructed. Compact leaves in $\hat{\mathcal{F}}(m)$ are $(S^1 \times I)_{2i}$ ($i=0, 1, \dots, m+1$) and

$\widehat{\mathcal{F}}(m)|(\mathbf{S}^1 \times \mathbf{I})_{2i+1}$ is the minus Reeb component if $i=1, 2, \dots, m$ and the slope component if $i=0, m+1$. The foliation $\widehat{\mathcal{F}}(m)$ is called the *standard TS component of type m* and denoted by $\widehat{\text{TS}}_m$. Clearly the lag functions f_j of $\widehat{\text{TS}}_m$ satisfy

$$f_1 = f_2 = \dots = f_m.$$

5. Classification theorems for foliations transverse to the Reeb component

Theorem 1. — Let \mathcal{F}' be a C^∞ foliation of codimension one transverse to the plus Reeb component $\mathcal{F}_R^{(+)}$ of $\mathbf{S}^1 \times \mathbf{D}^2$: $\mathcal{F}' \in t_1(\mathbf{S}^1 \times \mathbf{D}^2, \mathcal{F}_R^{(+)})$. Then the following conditions hold:

(i) Let $[\mathbf{L}_{\text{comp}}] = a\alpha + b\beta$ be the homology class of $\mathbf{H}_1(\mathbf{S}^1 \times \partial\mathbf{D}^2; \mathbf{Z})$ represented by a compact leaf \mathbf{L}_{comp} in $\mathcal{F}' = \mathcal{F}'|(\mathbf{S}^1 \times \partial\mathbf{D}^2)$, where $\alpha = [\mathbf{S}^1 \times \{*\}]$ with the given orientation, $\beta = [\{*\} \times \partial\mathbf{D}^2]$ and $a \geq 0$. Then we have $a=1$ or 2 (the number a is the longitudinal number of \mathcal{F}').

(ii) \mathcal{F}' consists of p copies of the plus half Reeb component, s_m copies of the TS component of type m for $m=1, 2, \dots, u$, and a finite number of foliated \mathbf{I} -bundles over $\mathbf{S}^1 \times \mathbf{I}$ in case $a=1$ and over $\mathbf{S}^1 \times \mathbf{I}$ or the Möbius band in case $a=2$ such that

$$p - \sum_{m=1}^u m s_m = 2 \quad \text{if} \quad a=1,$$

$$p - \sum_{m=1}^u m s_m = 1 \quad \text{if} \quad a=2,$$

and that the foliated \mathbf{I} -bundles are trivial \mathbf{I} -bundles in case $a=1$.

Proof. — (i) and a part of (ii) concerning plus and minus half Reeb components and TS components are direct consequences of Proposition 2 and Proposition 5.

Let $(\mathcal{F}_{R/2}^{(+)})_i$ ($i=1, 2, \dots, p$) and $(\text{TS}_m)_j$ ($j=1, 2, \dots, s_m$) be the plus Reeb components and the TS components of type m in \mathcal{F}' respectively, and let

$$\mathbf{M} = \mathbf{S}^1 \times \mathbf{D}^2 - \left(\bigcup_{i=1}^p \text{Int} | (\mathcal{F}_{R/2}^{(+)})_i | \right) - \left(\bigcup_{m=1}^u \left(\bigcup_{j=1}^{s_m} \text{Int} | (\text{TS}_m)_j | \right) \right).$$

Let \mathbf{C} be a connected component of \mathbf{M} , then, by Proposition 3, (ii) and Proposition 5, the family of simple curves formed by the intersection of $\mathbf{A}^{(x)}$ and leaves of $\mathcal{F}'| \mathbf{C}$ are transverse to $\partial\mathbf{A}^{(x)}$. This implies that $\mathcal{F}'| \mathbf{C}$ is a foliated \mathbf{I} -bundle isomorphic to $\overline{\mathcal{F}}'_C \times \mathbf{I}$ or $\widetilde{\overline{\mathcal{F}}}'_C \times \mathbf{I}/\mathbf{Z}_2$, where $\overline{\mathcal{F}}'_C$ denotes the restriction of $\overline{\mathcal{F}}' = \mathcal{F}'| \partial\mathbf{A}$ to one of the connected components of $\mathbf{C} \cap (\mathbf{S}^1 \times \partial\mathbf{D}^2)$ and $\widetilde{\overline{\mathcal{F}}}'_C$ denotes its double covering. Since $\overline{\mathcal{F}}'_C$ is a foliated \mathbf{I} -bundle over \mathbf{S}^1 such that this bundle is trivial if $a=1$ and is trivial or a Möbius band if $a=2$. Thus this theorem is proved.

In order to state the classification theorem for $t_1(\mathcal{F}_R^{(+)})$, we introduce the concept of TS diagram. TS diagrams consist of finite number of smooth simple arcs $\widehat{\ell}$

($i = 1, 2, \dots, r$) in the 2-disc D^2 and symbols $+$, $-$, \times and \parallel on $2r$ arc intervals of ∂D^2 divided by $\partial \hat{\ell}_i$ ($i = 1, 2, \dots, r$) satisfying the following conditions (Fig. 12, 14):

(i) $\hat{\ell}_i$ ($i = 1, 2, \dots, r$) are mutually disjoint smooth simple arcs in D^2 intersecting ∂D^2 transversely such that

$$\hat{\ell}_i \cap \partial D^2 = \partial \hat{\ell}_i \quad (i = 1, 2, \dots, r).$$

(ii) Let N_i ($i = 1, 2, \dots, r+1$) denote the closures of connected components of $D^2 - \bigcup_{i=1}^r \hat{\ell}_i$. Then the symbols are given as follows:

- (a) if $N_i \cap \partial D^2$ consists of one connected component, then the symbol $(+)$ is given on this arc interval;
- (b) if $N_i \cap \partial D^2$ consists of two connected components, then the symbol \parallel is given on each arc interval of $N_i \cap \partial D^2$;
- (c) if the number k of connected components of $N_i \cap \partial D^2$ is ≥ 3 , then the symbol $(-)$ is given for $k-2$ arc intervals of $N_i \cap \partial D^2$ and the symbol \times is given for the rest two arc intervals. Further two arc intervals with symbol \times are contained in a connected component of

$$\partial D^2 - [(k-2) \text{ arc intervals with symbol } (-)].$$

(iii) Let p and q denote the numbers of arc intervals having the symbol $(+)$ and $(-)$ respectively. Then $p - q = 2$.

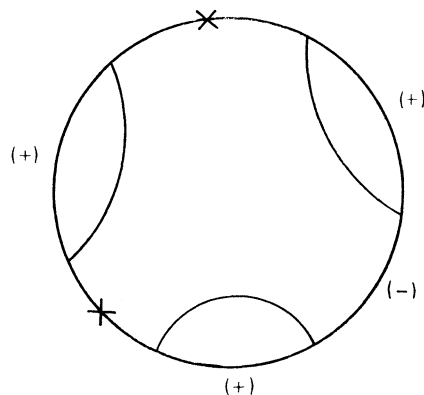

FIG. 12

The TS diagram of Figure 12 corresponds to \mathcal{F}' illustrated in Figure 5.

Two TS diagrams are *isomorphic* if and only if there exists a C^∞ diffeomorphism of D^2 preserving simple arcs $\{\hat{\ell}_i\}$ and symbols. Let $A = \bigcup_x A^{(x)}$ be as in Section 2, then the TS diagram illustrates $A^{(x)} \cap L'$ ($L' \in \mathcal{F}'$) (see Fig. 5).

The following theorem is an immediate consequence of Theorem 1 and the definition of TS diagrams.

Theorem 2. — Let $\mathcal{F}' \in t_1(\mathbf{S}^1 \times \mathbf{D}^2, \mathcal{F}_R^{(+)})$. Then a pair (a, b) of integers and an isomorphism class of TS diagrams satisfying the following conditions correspond uniquely to \mathcal{F}' .

(i) $a = 1$ or 2 . The homology class $[\mathbf{L}_{\text{comp}}]$ of $\mathbf{H}_1(\mathbf{S}^1 \times \partial\mathbf{D}^2; \mathbf{Z})$ represented by a compact leaf \mathbf{L}_{comp} in $\widehat{\mathcal{F}'} = \mathcal{F}' | \mathbf{S}^1 \times \partial\mathbf{D}^2$ is $a\alpha + b\beta$. In case $a = 1$, \mathcal{F}' is transversely orientable. In case $a = 2$, \mathcal{F}' is transversely non-orientable. The TS diagram should be invariant under the action of order 2 if $a = 2$.

(ii) Arc intervals of $\partial\mathbf{D}^2$ with symbols $+$, $-$, \times and $||$ represent the plus, the minus Reeb components, the slope components and foliated I-bundles over \mathbf{S}^1 (i.e. union of slope components and compact leaves) contained in \mathcal{F}' respectively.

(iii) In case $a = 1$ (resp. $a = 2$), \mathbf{N}_i (resp. a pair of \mathbf{N}_i which is invariant under the action of order 2) represents the plus half Reeb component or the TS component of type m or a foliated I-bundle over $\mathbf{S}^1 \times \mathbf{I}$ (resp. $\mathbf{S}^1 \times \mathbf{I}$ or the Möbius band) if $\mathbf{N}_i \cap \partial\mathbf{D}^2$ consists of one or $m + 2$ or 2 connected components respectively.

(iv) Each simple arc $\widehat{\ell}_i$ represents a compact leaf diffeomorphic to $\mathbf{S}^1 \times \mathbf{I}$ in case $a = 1$ and to $\mathbf{S}^1 \times \mathbf{I}$ or the Möbius band in case $a = 2$.

In the following we consider the topological classification for $t_1(\mathbf{S}^1 \times \mathbf{D}^2, \mathcal{F}_R^{(+)})$.

Lemma 8. — Any TS component \mathbf{TS}_m of type m is topologically isomorphic to the standard TS component $\widehat{\mathbf{TS}}_m$ of type m if the longitudinal number is 1.

Proof. — Let $\mathbf{L}_0, \mathbf{L}_1, \dots, \mathbf{L}_{m+1}$ (resp. $\widehat{\mathbf{L}}_0, \widehat{\mathbf{L}}_1, \dots, \widehat{\mathbf{L}}_{m+1}$) be compact leaves of \mathbf{TS}_m (resp. $\widehat{\mathbf{TS}}_m$). We fix \mathbf{C}^∞ diffeomorphisms

$$\gamma_i : \mathbf{S}^1 \times \mathbf{I} \rightarrow \mathbf{L}_i \quad (\text{resp. } \widehat{\gamma}_i : \mathbf{S}^1 \times \mathbf{I} \rightarrow \widehat{\mathbf{L}}_i) \quad (i = 0, 1, \dots, m+1).$$

Then it is easy to see that there exists a collar c (resp. \widehat{c}) of $\bigcup_{i=0}^{m+1} \mathbf{L}_i$ (resp. $\bigcup_{i=0}^{m+1} \widehat{\mathbf{L}}_i$) in $|\mathbf{TS}_m|$ (resp. $|\widehat{\mathbf{TS}}_m|$):

$$c : \left(\bigcup_{i=0}^{m+1} \mathbf{L}_i \right) \times [0, 1] \rightarrow |\mathbf{TS}_m|, \quad c(z, 0) = z \quad \left(z \in \bigcup_{i=0}^{m+1} \mathbf{L}_i \right)$$

$$(\text{resp. } \widehat{c} : \left(\bigcup_{i=0}^{m+1} \widehat{\mathbf{L}}_i \right) \times [0, 1] \rightarrow |\widehat{\mathbf{TS}}_m|, \quad \widehat{c}(z, 0) = z \quad \left(z \in \bigcup_{i=0}^{m+1} \widehat{\mathbf{L}}_i \right))$$

such that

- (a) $c(\bigcup_{i=0}^{m+1} \mathbf{L}_i \times \{1\})$ (resp. $\widehat{c}(\bigcup_{i=0}^{m+1} \widehat{\mathbf{L}}_i \times \{1\})$) is transverse to \mathbf{TS}_m (resp. $\widehat{\mathbf{TS}}_m$),
- (b) $c(\{z\} \times [0, 1])$ (resp. $\widehat{c}(\{z\} \times [0, 1])$) is transverse to \mathbf{TS}_m (resp. $\widehat{\mathbf{TS}}_m$),
- (c) $c(\gamma_i(\{x\} \times \mathbf{I}), t)$ (resp. $\widehat{c}(\widehat{\gamma}_i(\{x\} \times \mathbf{I}), t)$) is contained in a leaf of \mathbf{TS}_m (resp. $\widehat{\mathbf{TS}}_m$), where $t \in [0, 1]$.

Since, by Proposition 6, the restriction of TS_m (resp. $\widehat{\text{TS}}_m$) to

$$Q' = |\text{TS}_m| - c\left(\prod_{i=0}^{m+1} L_i\right) \times [0, 1] \quad (\text{resp. } \widehat{Q}' = |\widehat{\text{TS}}_m| - \widehat{c}\left(\prod_{i=0}^{m+1} \widehat{L}_i\right) \times [0, 1])$$

is a C^∞ foliation of codimension one whose leaves are the regular polygon P_{2m+4} with $2m+4$ vertices, it follows from the Reeb stability theorem [5] that $\text{TS}_m|Q'$ (resp. $\widehat{\text{TS}}_m|\widehat{Q}'$) is a product foliation. Thus, as is easily verified, there exists a C^∞ diffeomorphism

$$h_{Q'} : Q' \rightarrow \widehat{Q}'$$

such that

- (i) $h_{Q'}$ preserves the foliations $\text{TS}_m|Q'$ and $\widehat{\text{TS}}_m|\widehat{Q}'$,
- (ii) $h_{Q'}(L_i \times \{1\}) = \widehat{L}_i \times \{1\}$.

Further, letting $h_Q(z, 1) = (z', 1)$ ($z \in L_i$), we define surjective homeomorphisms

$$h_i : c(L_i \times [0, 1]) \rightarrow \widehat{c}(\widehat{L}_i \times [0, 1]), \quad i = 0, 1, \dots, m+1,$$

by $h_i(z, t) = (z', \xi_z(t))$,

where $\xi_z : [0, 1] \rightarrow [0, 1]$ is a surjective homeomorphism depending continuously on z . By a suitable choice of ξ_z , the homeomorphisms h_i preserve the foliations $\text{TS}_m|c(L_i \times [0, 1])$ and $\widehat{\text{TS}}_m|\widehat{c}(\widehat{L}_i \times [0, 1])$.

Then the homeomorphism

$$h : |\text{TS}_m| \rightarrow |\widehat{\text{TS}}_m|$$

defined by $h|Q' = h_{Q'}$ and $h|c(L_i \times I) = h_i$ ($i = 0, 1, \dots, m+1$) is a surjective homeomorphism preserving foliations TS_m and $\widehat{\text{TS}}_m$. Thus this lemma is proved.

The following theorem is an immediate consequence of Theorem 2 and Lemma 8.

Theorem 3. — Let $\mathcal{F}'_1, \mathcal{F}'_2 \in t_1(S^1 \times D^2, \mathcal{F}_R^{(+)})$. Suppose that \mathcal{F}'_1 and \mathcal{F}'_2 satisfy the following conditions:

- (i) \mathcal{F}'_1 and \mathcal{F}'_2 have the same longitudinal number;
- (ii) there exists an isomorphism between their TS diagrams, say f_0 ;
- (iii) for foliated I-bundles in \mathcal{F}'_1 and in \mathcal{F}'_2 corresponding by f_0 , there exists an isomorphism between them compatible with f_0 .

Then \mathcal{F}'_1 and \mathcal{F}'_2 are topologically isomorphic.

Let us consider $\mathcal{F}'_1 \in t_1(S^1 \times D^2, \mathcal{F}_R^{(+)})$ consisting of 3 copies of the half Reeb component and one TS component of type I (Fig. 12). We represent \mathcal{F}'_1 by illustrating $\mathcal{F}'_1 \cap A^{(x)}$ and $\mathcal{F}'_1|(S^1 \times \partial D^2)$ by dotted curves in Figure 13.

Let \mathcal{F}'_1'' be an element of $t_1(S^1 \times D^2, \mathcal{F}_R^{(+)})$ represented by real curves illustrating $\mathcal{F}'_1'' \cap A^{(x)}$ and $\mathcal{F}'_1''|(S^1 \times \partial D^2)$ in Figure 13. The foliation \mathcal{F}'_1'' consists of 2 copies of the half Reeb component and a foliated I-bundle over $S^1 \times I$, and is transverse to \mathcal{F}'_1 :

$$\mathcal{F}'_1'' \bar{\cap} \mathcal{F}'_1.$$

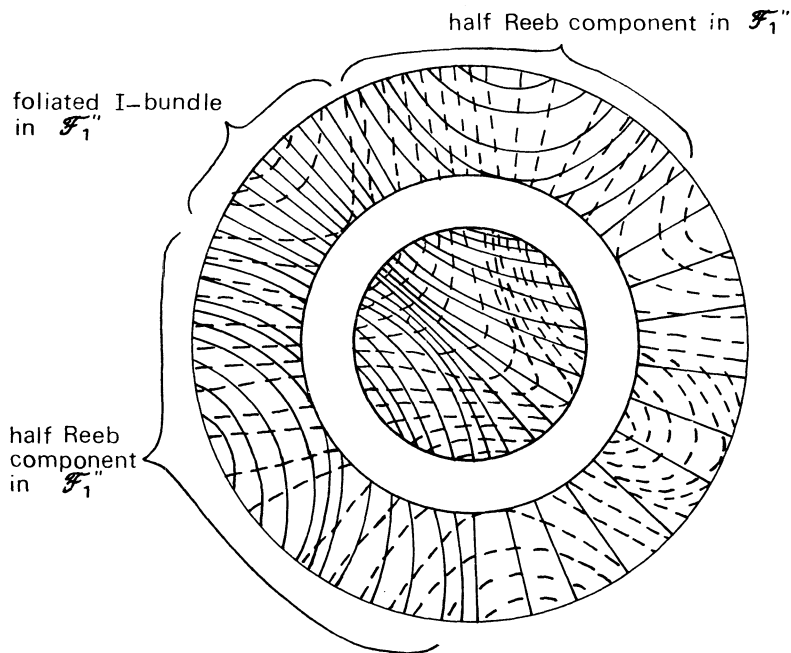

FIG. 13

For $\mathcal{F}' \in t_1(S^1 \times D^2, \mathcal{F}_R^{(+)})$ consisting of m copies of the half Reeb component and one TS component of type $m-1$, we can construct $\mathcal{F}'' \in t_1(S^1 \times D^2, \mathcal{F}_R^{(+)})$ such that $\mathcal{F}'' \bar{\cap} \mathcal{F}'$ by similar methods. It seems to us that, for any $\mathcal{F}' \in t_1(S^1 \times D^2, \mathcal{F}_R^{(+)})$, there exists always $\mathcal{F}'' \in t_1(S^1 \times D^2, \mathcal{F}_R^{(+)})$ such that $\mathcal{F}' \bar{\cap} \mathcal{F}''$. However, in general, \mathcal{F}'' is not unique, because \mathcal{F}_1'' above is also transverse to $\mathcal{F}_1''' \in t_1(S^1 \times D^2, \mathcal{F}_R^{(+)})$ consisting of 2 copies of the half Reeb component (Fig. 4).

6. Foliations transverse to the Reeb foliation of S^3

Let $S^3 = (S_1^1 \times D_1^2) \cup_h (D_2^2 \times S_2^1)$ be the decomposition of the 3-sphere into the union of two solid tori, where $h: S_1^1 \times \partial D_1^2 \rightarrow \partial D_2^2 \times S_2^1$ is given by $h(x, y) = (x, y)$.

Let \mathcal{F}_R denote the Reeb foliation of S^3 . We fix orientations on S_1^1 and S_2^1 so that $'\mathcal{F}_R = \mathcal{F}_R|_{(S_1^1 \times D_1^2)}$ and $''\mathcal{F}_R = \mathcal{F}_R|_{(D_2^2 \times S_2^1)}$ are the plus Reeb components.

Let \mathcal{F}' be a C^∞ foliation of codimension one of S^3 transverse to \mathcal{F}_R . Then we have

$$\mathcal{F}'|_{(S_1^1 \times D_1^2)}, \mathcal{F}'|_{(D_2^2 \times S_2^1)} \in t_1(S^1 \times D^2, \mathcal{F}_R^{(+)}).$$

Since \mathcal{F}' is transversely orientable, their longitudinal numbers are both 1. The restrictions $\mathcal{F}'|_{(S_1^1 \times D_1^2)}$ and $\mathcal{F}'|_{(D_2^2 \times S_2^1)}$ must be isomorphic by h on their boundaries. Thus it is obvious that the homology class $[L_{\text{comp}}]$ of $H_1(S_1^1 \times \partial D_1^2; \mathbf{Z})$ represented by

a compact leaf L_{comp} of $\widehat{\mathcal{F}}' = \mathcal{F}' | \partial(S^1 \times D^2)$ having the orientation compatible with the orientations of S^1 and S^2 is $\alpha + \beta$, where $\alpha = [S^1 \times \{*\}]$, $\beta = [\{\bullet\bullet\} \times S^2]$ ($\{*\}, \{\bullet\bullet\} \in \partial D^2$) with given orientations (Theorem 1, (i)).

Conversely from two elements $\mathcal{F}'_1, \mathcal{F}'_2 \in t_1(S^1 \times D^2, \mathcal{F}_R^{(+)})$ with the longitudinal number 1 such that $\mathcal{F}'_1 | \partial(S^1 \times D^2)$ is isomorphic to $\mathcal{F}'_2 | \partial(S^1 \times D^2)$ by the map $(x, y) \rightarrow (y, x)$, we obtain an $\mathcal{F}' \in t_1(S^3, \mathcal{F}_R)$ by identifying their boundaries. Thus the following theorem holds:

Theorem 4. — Let \mathcal{F}' be a C^∞ foliation of codimension one transverse to the Reeb foliation \mathcal{F}_R of S^3 : $\mathcal{F}' \in t_1(S^3, \mathcal{F}_R)$. Then \mathcal{F}' is obtained from two foliations $\widehat{\mathcal{F}}'_1, \widehat{\mathcal{F}}'_2 \in t_1(S^1 \times D^2, \mathcal{F}_R^{(+)})$ with longitudinal number 1 such that $\widehat{\mathcal{F}}'_1 | \partial(S^1 \times D^2)$ is isomorphic to $\widehat{\mathcal{F}}'_2 | \partial(S^1 \times D^2)$ by the map $(x, y) \rightarrow (y, x)$ identifying their boundaries.

Let D_i^2 ($i = 0, 1, \dots, m+1$) be 2-discs imbedded disjointly in the 2-sphere S^2 and let $C = (S^2 - \bigcup_{i=0}^{m+1} \text{Int } D_i^2) \times S^1$. We fix an orientation on S^1 . A full TS component of type $(m; r)$, denoted by $\overline{\text{TS}}_{(m; r)}$, is a C^∞ foliation \mathcal{F}_C of codimension one of C having the following properties:

- (i) Compact leaves of \mathcal{F}_C are $\partial D_i^2 \times S^1$ ($i = 0, 1, \dots, m+1$).
- (ii) Interior leaves of \mathcal{F}_C are transverse to $\{x\} \times S^1$ ($x \in S^2 - \bigcup_{i=0}^{m+1} D_i^2$).
- (iii) \mathcal{F}_C has a contracting holonomy in the negative direction of S^1 on $\partial D_i^2 \times S^1$ ($i = 0, 1, \dots, r$) and in the positive direction of S^1 on $\partial D_i^2 \times S^1$ ($i = r+1, r+2, \dots, m+1$), where $0 \leq r \leq m$. We note that a full TS component contains compact leaves having contracting holonomy in different directions of S^1 .

Example A. — Let us consider two copies of

$$\widehat{\mathcal{F}}' \in t_1(S^1 \times D^2, \mathcal{F}_R^{(+)}) \quad \text{with} \quad [L_{\text{comp}}] = \alpha + \beta.$$

We may suppose that h gives an isomorphism $\mathcal{F}_R^{(+)} | (S^1 \times \partial D^2) \rightarrow \mathcal{F}_R^{(+)} | (S^1 \times \partial D^2)$. Thus the C^∞ foliation \mathcal{F}' obtained from two copies of $\widehat{\mathcal{F}}'$ identifying their boundaries by h is an element of $t_1(S^3, \mathcal{F}_R)$. If $\widehat{\mathcal{F}}'$ consists of p copies of the plus half Reeb component, s_m copies of the TS component of type m ($m = 1, 2, \dots, u$), then \mathcal{F}' consists of p copies of the Reeb component and s_m copies of the full TS component of type $(m; 0)$.

Example B (Koichi Yano). — Let $\widehat{\mathcal{F}}'_1, \widehat{\mathcal{F}}'_2$ be elements of $t_1(S^1 \times D^2, \mathcal{F}_R^{(+)})$ with $[L_{\text{comp}}] = \alpha + \beta$ such that their TS diagrams are given by Figure 14, (a), (b) respectively and that h gives an isomorphism $\widehat{\mathcal{F}}'_1 | (S^1 \times \partial D^2) \rightarrow \widehat{\mathcal{F}}'_2 | (S^1 \times \partial D^2)$ (thus, the symbol \parallel in their TS diagrams represent slope components). The C^∞ foliation \mathcal{F}' obtained from $\widehat{\mathcal{F}}'_1$ and $\widehat{\mathcal{F}}'_2$ identifying their boundaries by h is an element of $t_1(S^3, \mathcal{F}_R)$ consisting of 7 copies of the Reeb component, a full TS component of type $(1; 1)$ and a full TS component of type $(3; 1)$.

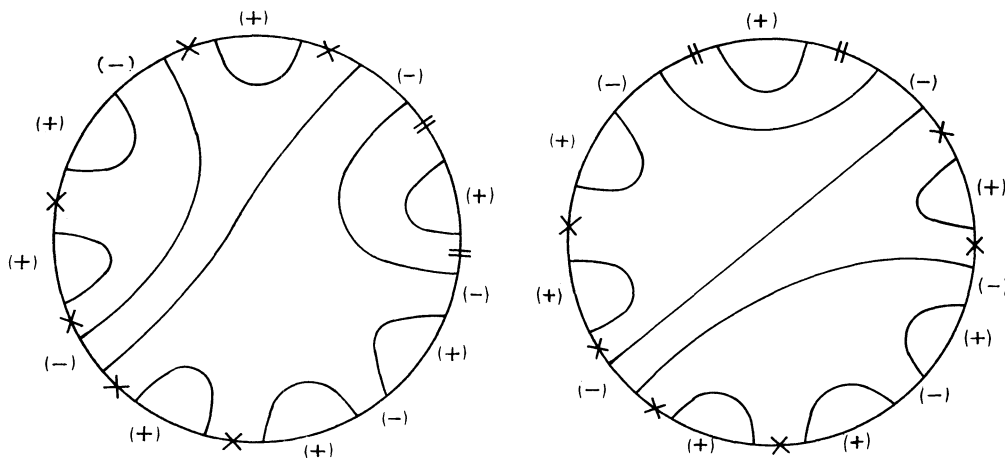

FIG. 14

Theorem 5. — Let $\mathcal{F}' \in t_1(\mathbb{S}^3, \mathcal{F}_R)$, then \mathcal{F}' consists of a finite number of Reeb components, full TS components and foliated I-bundles over $\mathbb{S}^1 \times \mathbb{S}^1$. Furthermore, let ℓ_R , etc. (resp. ℓ_{TS}) denote a closed curve in a Reeb component (resp. a full TS component) in \mathcal{F}' homotopic to the longitude and transverse to \mathcal{F}' , then ℓ_R and ℓ_{TS} are both unknotted and the linking number of ℓ_R and ℓ'_R is ± 1 .

Proof. — Let $\widehat{\mathcal{F}}'_1, \widehat{\mathcal{F}}'_2$ be as in Theorem 4: $\mathcal{F}' = \widehat{\mathcal{F}}'_1 \cup \widehat{\mathcal{F}}'_2$. First assume that the number of compact leaves contained in $\widehat{\mathcal{F}}'_1$ (thus also in $\widehat{\mathcal{F}}'_2$) is finite. This is equivalent to the assumption that foliated I-bundles in $\widehat{\mathcal{F}}'_1$ and in $\widehat{\mathcal{F}}'_2$ contain only a finite number of compact leaves. For a compact leaf L_1 in $\widehat{\mathcal{F}}'_1$, $L_1 \cap (\mathbb{S}^1 \times \partial D^2)$ consists of two compact leaves in $\widehat{\mathcal{F}}'_2 | (\mathbb{S}^1 \times \partial D^2)$, say \bar{L}_1, \bar{L}_1 . Then there exists a unique compact leaf in $\widehat{\mathcal{F}}'_2$, say L_2 (resp. L'_2), which contains \bar{L}_1 (resp. \bar{L}_1). Thus the set of compact leaves in $\widehat{\mathcal{F}}'_1$ and $\widehat{\mathcal{F}}'_2$ forms a finite number of compact leaves in \mathcal{F}' which are diffeomorphic to $\mathbb{S}^1 \times \mathbb{S}^1$. By Proposition 2, (iii), the numbers of plus half Reeb components in $\widehat{\mathcal{F}}'_1$ and in $\widehat{\mathcal{F}}'_2$ are the same and they form the same number of Reeb components in \mathcal{F}' . Further, as is easily verified, TS components and foliated I-bundles in $\widehat{\mathcal{F}}'_1$ and in $\widehat{\mathcal{F}}'_2$ form a finite number of full TS components and foliated I-bundles over $\mathbb{S}^1 \times \mathbb{S}^1$ with finite compact leaves in \mathcal{F}' (Examples A, B). Since $[L_{\text{comp}}] = \alpha + \beta$, it follows from the construction as above that ℓ_R and ℓ_{TS} are unknotted and the linking number of ℓ_R and ℓ'_R is ± 1 . Thus the theorem is proved in this case.

Now suppose that $\widehat{\mathcal{F}}'_1$ (thus also $\widehat{\mathcal{F}}'_2$) contains foliated I-bundles with infinite numbers of compact leaves. We denote $A, A^{(x)}$ and $\{\ell_\lambda^{(x)}\}_{\lambda \in \Lambda(x)}$ of Section 3 for $\widehat{\mathcal{F}}'_1$ (resp. $\widehat{\mathcal{F}}'_2$) by $A_1, A_1^{(x)}$ and $\{\ell_\lambda^{(x)}\}_{\lambda \in \Lambda'(x)}$ (resp. $A_2, A_2^{(x)}$ and $\{\ell'_\lambda^{(x)}\}_{\lambda \in \Lambda''(x)}$). Since $[L_{\text{comp}}] = \alpha + \beta$, the diffeomorphism h induces naturally a diffeomorphism

$$\bar{h}: \partial A_1^{(x_1)} \rightarrow \partial A_2^{(x_2)}$$

such that $\bar{h}(y) \in h(\bar{L})$ for $y \in \bar{L}$. Let \hat{S} be the 2-sphere obtained from $A_1^{(x_1)}$ and $A_2^{(x_2)}$ identifying their boundaries by \bar{h} . Then we may consider that

$$\mathcal{L} = \{\ell_\lambda^{(x_1)}\}_{\lambda \in \Lambda'(x_1)} \cup \{\ell_\lambda^{(x_2)}\}_{\lambda \in \Lambda''(x_2)}$$

is a family of integral curves of a C^∞ vector field Y on \hat{S} which is non-singular except $\partial A_1^{(x_1)} \cap (\hat{\Sigma}^{(+)} \cup \hat{\Sigma}^{(-)})$. Here \mathcal{L} represents the leaves of \mathcal{F}' . If there exists a sequence of an infinite number of compact leaves $L_1^{(1)}, L_2^{(2)}, L_1^{(3)}, L_2^{(4)}, \dots, L_1^{(2s-1)}, L_2^{(2s)}, \dots$ such that

$$\begin{aligned} L_1^{(2s-1)} \in \hat{\mathcal{F}}_1', \quad L_2^{(2s)} \in \hat{\mathcal{F}}_2', \\ L_1^{(2s-1)} \cap L_2^{(2s)} \neq \emptyset, \quad L_2^{(2s)} \cap L_1^{(2s+1)} \neq \emptyset \quad (s = 1, 2, 3, \dots), \end{aligned}$$

and that the union $(\bigcup_{s=1}^{\infty} L_1^{(2s-1)}) \cup (\bigcup_{s=1}^{\infty} L_2^{(2s)})$ is a non-compact leaf of \mathcal{F}' , then, letting $L_1^{(2s-1)} \cap A_1^{(x_1)} = \hat{\ell}^{(2s-1)}$, $L_2^{(2s)} \cap A_2^{(x_2)} = \hat{\ell}^{(2s)}$, the union $\hat{\ell} = \bigcup_{s=1}^{\infty} \hat{\ell}^{(s)}$ is a non-compact integral

curve of Y . By the Poincaré-Bendixson theorem, the ω -limit set of $\hat{\ell}$ is a circle, say ω . We denote by L_ω the leaf of \mathcal{F}' containing ω and by \bar{L}_ω a connected component of $L_\omega \cap \partial A_1$. Then, it is obvious that \bar{L}_ω cannot be a non-compact leaf (i.e. an interior leaf of a slope component) of $\hat{\mathcal{F}}_1' | \partial A_1$. This implies that L_ω is a compact leaf of \mathcal{F}' diffeomorphic to $S^1 \times S^1$, say $L_\omega = \omega \times S^1$. Let $\bar{L}^{(2s-1)}$ (resp. $\bar{L}^{(2s)}$) denote a connected component of $L_1^{(2s-1)} \cap \partial A_1$ (resp. $L_2^{(2s)} \cap \partial A_2$), then there exists a sequence of compact leaves $\bar{L}^{(s_1)}, \bar{L}^{(s_2)}, \dots, \bar{L}^{(s_q)}, \dots$ of $\hat{\mathcal{F}}_1' | \partial A_1 = \hat{\mathcal{F}}_2' | \partial A_2$ such that this sequence converges to \bar{L}_ω . If, for a given integer q' , there always exists an integer $q > q'$ such that a slope component of $\hat{\mathcal{F}}_1' | \partial A_1$ (maybe contained in a foliated I-bundle of $\hat{\mathcal{F}}_1' | \partial A_1$) situated between $\bar{L}^{(s_q)}$ and $\bar{L}^{(s_{q+1})}$, then L_ω has contracting holonomy in both $[\omega]$, $[\{*\} \times S^1]$ ($* \in \omega$). Since \mathcal{F}' is of class C^∞ , this contradicts to the Kopell's theorem [2]. Therefore, for a compact leaf \bar{L} of the boundary of a slope component of $\hat{\mathcal{F}}_1' | \partial A_1$, the saturation of \bar{L} in \mathcal{F}' is a compact leaf of \mathcal{F}' . Thus, as is easily verified, for a slope component $\bar{\mathcal{F}}_s'$ in $\hat{\mathcal{F}}_1' | \partial A_1$, one of the following occurs:

(i) The saturation of $|\bar{\mathcal{F}}_s'|$ in \mathcal{F}' contains a TS component of $\hat{\mathcal{F}}_1'$ or $\hat{\mathcal{F}}_2'$.

(ii) The saturation of $|\bar{\mathcal{F}}_s'|$ in \mathcal{F}' forms a foliated I-bundle over $S^1 \times S^1$ with two compact leaves.

Further, let $\bar{\mathcal{F}}$ be a subset of $\hat{\mathcal{F}}_1' | \partial A_1$ which satisfies the following:

- (a) $\bar{\mathcal{F}}$ consists of compact leaves;
- (b) the union of the leaves in $\bar{\mathcal{F}}$ is diffeomorphic to $S^1 \times I$;
- (c) the boundary of $|\bar{\mathcal{F}}|$ consists of two compact leaves which belong to the boundaries of slope components.

Then the saturation of $|\bar{\mathcal{F}}|$ in \mathcal{F}' is a foliated I-bundle over $S^1 \times S^1$.

It is obvious that the union of two foliated I-bundles over $S^1 \times S^1$ with a common

compact leaf forms a foliated I-bundle over $S^1 \times S^1$. Moreover, let F be the saturation in \mathcal{F}' of a sufficiently small subset of ∂A_1 such that the boundary of F consists of two compact leaves, then we can show that $\mathcal{F}'|F$ is a foliated I-bundle over $S^1 \times S^1$ by constructing a vector field transverse to $\mathcal{F}'|F$.

By the observation above, there exist foliated I-bundles $\mathcal{F}'_1, \mathcal{F}'_2, \dots, \mathcal{F}'_u$ over $S^1 \times S^1$ in \mathcal{F}' such that $S^3 - \bigcup_{i=1}^u \text{Int } |\mathcal{F}'_i|$ contains only a finite number of compact leaves. So the theorem reduces to the case above. Thus the theorem is proved.

Remark. — The properties of the full TS component in \mathcal{F}' depend mainly on the lag functions of two TS components contained in it. For example, see [10] for the Godbillon-Vey classes of TS components.

7. Foliations of codimension one of S^3 admitting no transverse foliation of codimension one

Let k be a fibred knot in S^3 . That is, letting $N(k)$ be a tubular neighborhood of k , $E = S^3 - \text{Int } N(k)$ is a C^∞ fibre bundle over S^1 , $\pi: E \rightarrow S^1$, with fibre $G - \text{Int } D^2$ where G is a closed surface of genus g and D^2 is a 2-disc imbedded in G . For example, the intersection k of $S^3 = \{(z_1, z_2); |z_1|^2 + |z_2|^2 = 1\}$ and $\{(z_1, z_2); z_1^p + z_2^q = 0\}$ is a fibred knot [3].

Let \mathcal{F} be a C^∞ foliation of codimension one of S^3 constructed by the spinnable structure having the fibred knot as the axis ([8]). That is, by choosing suitable orientations on S^1 of $S^1 \times D^2$ and on S^1 of $E \rightarrow S^1$, \mathcal{F} is the union of the plus Reeb component $\mathcal{F}_R^{(+)}$ of $N(k) = S^1 \times D^2$ and the C^∞ foliation $\mathcal{F}_\pi^{(+)}$ of Proposition 2: $\mathcal{F} = \mathcal{F}_R^{(+)} \cup \mathcal{F}_\pi^{(+)}$. Then we have the following theorem.

Theorem 6. — Let \mathcal{F} be a C^∞ foliation of codimension one of S^3 defined from a fibred knot k as above, where the genus g is ≥ 1 . Then \mathcal{F} does not admit any transverse C^∞ foliation of codimension one:

$$t_1(S^3, \mathcal{F}) = \emptyset.$$

Proof. — Suppose there exists $\mathcal{F}' \in t_1(S^3, \mathcal{F})$. Let α and β denote the homology classes of $H_1(\partial E; \mathbf{Z})$ represented by a meridian of $N(k)$ and $\partial(G - \text{Int } D^2)$ with orientations chosen as above respectively. Then, by Proposition 2, a compact leaf L_{comp} of $\mathcal{F}'| \partial E$ represents a homology class $\bar{a}\alpha + \bar{b}\beta$ ($\bar{a} \geq 0$), and $\mathcal{F}'| \partial E$ contains p copies of the plus Reeb component and q copies of the minus Reeb component, where

$$\bar{a}(p - q) = 2(1 - 2g).$$

On the other hand, also by Proposition 2, (iii), since \mathcal{F}' is transversely orientable, $\mathcal{F}'| \partial N(k)$ contains p' copies of the plus Reeb component and q' copies of the minus Reeb component with

$$(*) \quad p' - q' = 2$$

and $\bar{b} = \pm 1$. Since

$$p - q = \pm (p' - q'),$$

it follows that

$$(**) \quad p - q = -2, \quad \bar{a} = 2g - 1.$$

\mathcal{F}' has a Reeb component ([4]), say $\mathcal{F}'_R, |\mathcal{F}'_R| \subset S^3$. If $|\mathcal{F}'_R| \subset N(k)$, then obviously $|\mathcal{F}'_R| \subset \text{Int } N(k)$. Thus $\mathcal{F}'|_{|\mathcal{F}'_R|}$ consists of compact leaves. On the other hand, since $\mathcal{F}'|_{|\mathcal{F}'_R|} \in t_1(\mathcal{F}'_R)$, $\mathcal{F}'|_{|\mathcal{F}'_R|}$ must contain non-compact leaves by Theorem 1. This contradiction implies that

$$|\mathcal{F}'_R| \not\subset N(k).$$

Similarly we have

$$|\mathcal{F}'_R| \not\subset E.$$

Since $\mathcal{F}'|_{N(k)} \in t_1(N(k), \mathcal{F}'_R^{(+)})$, $\mathcal{F}'|_{N(k)}$ satisfies the conditions of Theorem 1. Now we consider $\mathcal{F}'_R|(N(k) \cap |\mathcal{F}'_R|)$. If there exists a TS component in

$$\mathcal{F}'_R|(N(k) \cap |\mathcal{F}'_R|),$$

say TS_m , then the longitude of $|TS_m|$ and that of $|\mathcal{F}'_R|$ must coincide. This contradicts that TS_m contains compact leaves having the contracting holonomy in both positive and negative directions (Proposition 6). Thus $\mathcal{F}'_R|(N(k) \cap |\mathcal{F}'_R|)$ does not contain a TS component. Similarly, by the fact that $[L_{\text{comp}}] = (2g - 1)\alpha \pm \beta$, $\mathcal{F}'_R|(N(k) \cap |\mathcal{F}'_R|)$ does not contain a foliated I-bundle. Therefore, $\mathcal{F}'_R|(N(k) \cap |\mathcal{F}'_R|)$ should consist of half Reeb components.

Since $\mathcal{F}'|_{|\mathcal{F}'_R|}$ is transverse to a Reeb component \mathcal{F}'_R , $\mathcal{F}'|(E \cap |\mathcal{F}'_R|)$ consists of half Reeb components, TS components and foliated I-bundles over $S^1 \times I$ by Theorem 1. If $\mathcal{F}'|(E \cap |\mathcal{F}'_R|)$ contains a TS component, say TS'_m , then, since compact leaves of TS'_m have contracting holonomy, they must be subsets of ∂E . However, \mathcal{F} has the contracting holonomy in one direction on $\partial N(k)$ in the side of E . This contradicts the property of TS components about contracting holonomy. Thus $\mathcal{F}'|(E \cap |\mathcal{F}'_R|)$ cannot contain a TS component. Similarly, by the fact that $[L_{\text{comp}}] = (2g - 1)\alpha \pm \beta$, $\mathcal{F}'|(E \cap |\mathcal{F}'_R|)$ cannot contain a foliated I-bundle. Thus $\mathcal{F}'|(E \cap |\mathcal{F}'_R|)$ must consist of half Reeb components. This shows that $E \cap |\mathcal{F}'_R|$ is diffeomorphic to the disjoint union of a finite number of copies of $S^1 \times D_+^2$. Further, since $\mathcal{F}'_R|(N(k) \cap |\mathcal{F}'_R|)$ consists of half Reeb components, $\mathcal{F}'|(E \cap |\mathcal{F}'_R|)$ is a half Reeb component, and, thus, $\mathcal{F}'_R|(N(k) \cap |\mathcal{F}'_R|)$ is also a half Reeb component.

Moreover, since $\mathcal{F}'_R|(\partial N(k) \cap |\mathcal{F}'_R|)$ is a plus Reeb component in $\mathcal{F}'|_{\partial N(k)}$, it follows from (*), (**) that $\mathcal{F}'_R|(\partial E \cap |\mathcal{F}'_R|)$ is a minus Reeb component in $\mathcal{F}'|_{\partial E}$.

Let $c(\partial E)$ be a sufficiently small collar of ∂E in E and denote $A_E = E - c(\partial E)$. Then, for a non-compact leaf L of $\mathcal{F}'|(E \cap |\mathcal{F}'_R|)$, $L \cap A_E$ is a half-disc. Thus the Euler number $\chi(L \cap A_E) = 1$.

We may consider that the family of curves $\{L \cap A_E \cap L'; L' \in \mathcal{F}'\}$ is that of integral curves of a C^∞ vector field V_L on $L \cap A_E$ such that V_L is tangent to $L \cap A_E \cap \partial|\mathcal{F}'_R|$ and is non-singular except at one point of $L \cap A_E$, say \hat{p} . The singularity of V_L at \hat{p} is of minus type, because $\mathcal{F}'_R|(\partial E \cap |\mathcal{F}'_R|)$ is a minus Reeb component in $\mathcal{F}'|E$. Let $D(L \cap A_E)$ denote the double of $L \cap A_E$ obtained from two copies of $L \cap A_E$ by pasting at $L \cap \partial A_E$, then the Euler number of $D(L \cap A_E)$ is -1 . On the other hand, it follows from $\chi(L \cap A_E) = 1$ that $\chi(D(L \cap A_E)) = 1$. This is a contradiction. Thus there exists no \mathcal{F}' . This completes the proof.

As a corollary of Theorem 6, we have the following theorem.

Theorem 7. — Let $\bar{\mathcal{F}}$ be a C^∞ foliation of codimension 2 which is a subfoliation of \mathcal{F} of Theorem 6. Then $\bar{\mathcal{F}}$ does not admit any transverse C^∞ foliation of codimension one:

$$t_0(S^3, \bar{\mathcal{F}}) = \emptyset.$$

Proof. — Clearly $\bar{\mathcal{F}}$ exists (cf. Proposition 1). Suppose $\mathcal{F}' \in t_0(S^3, \bar{\mathcal{F}})$. Then it is obvious that $\mathcal{F}' \in t_1(S^3, \mathcal{F})$. This contradicts the result of Theorem 6.

8. Problems

The following are some problems raised by the results of this paper.

Problem 1. — Classify or characterize C^∞ subfoliations of codimension 2 of the Reeb component $(S^1 \times D^2, \mathcal{F}_R^{(+)})$. In case the restriction of the subfoliation to $S^1 \times \partial D^2$ consists of two copies of the half Reeb foliation, do they coincide with $\mathcal{F}_R^{(+)} \cap \mathcal{F}'$ ($\mathcal{F}' \in t_1(\mathcal{F}_R^{(+)})$ of Fig. 4)?

Problem 2. — Determine $t_1^m(S^1 \times D^2, \mathcal{F}_R^{(+)})$ for $m = 2, 3, \dots$. Does there exist a stability: $t_1^m(S^1 \times D^2, \mathcal{F}_R) = t_1^{m+2}(S^1 \times D^2, \mathcal{F}_R) = \dots = t_1^{m+2j}(S^1 \times D^2, \mathcal{F}_R) = \dots$?

Problem 3. — Classify or characterize C^∞ subfoliations of codimension 2 of the Reeb foliation (S^3, \mathcal{F}_R) .

Problem 4. — Characterize C^∞ foliations of codimension 2 of S^3 which have superfoliations of codimension one.

Problem 5. — Does there exist a C^∞ foliation \mathcal{F} of codimension one of S^3 such that $t_1(\mathcal{F}) \neq \emptyset$ and $t_1(\mathcal{F}) \cap t_1(\mathcal{F}') = \emptyset$ for some $\mathcal{F}' \in t_1(\mathcal{F})$.

Problem 6. — Characterize C^∞ foliations contained in the limit of the sequence $\{(S^3, \mathcal{F}_R)\} \subset t_1(S^3, \mathcal{F}_R) \subset \dots \subset t_1^m(S^3, \mathcal{F}_R) \subset \dots$. Does there exist a stability for this sequence? Is $t_1^2(S^3, \mathcal{F}_R) = t_1(S^3, \mathcal{F}_R)$?

Problem 7. — Does there exist a C^∞ foliation of codimension one of S^3 such that $t_1(S^3, \mathcal{F})$ (or the limit of the sequence $t_1(S^3, \mathcal{F}) \subset \dots \subset t_1^m(S^3, \mathcal{F}) \subset \dots$) is equal to the

set of C^∞ foliations of codimension one which admit transverse C^∞ foliations of codimension one.

Problem 8. — For $(S^3, \mathcal{F}') \in t_1(S^3, \mathcal{F}_R)$, is it true that “ the Godbillon-Vey number zero ” implies “ cobordant to zero ”?

Problem 9. — Consider the deformation classes in $t_1(S^3, \mathcal{F}_R)$.

Problem 10. — Find conditions for C^∞ foliated manifolds to admit transverse foliations.

REFERENCES

- [1] A. DAVIS and F. W. WILSON, JR., Vector fields tangent to foliations 1: Reeb foliations, *Jour. Differential equations*, 11 (1972), 491-498.
- [2] N. KOPELL, Commuting Diffeomorphisms, Global Analysis, *Proc. Symp. Pure Math.*, XIV, A.M.S., 1970, Providence.
- [3] J. MILNOR, *Singular points of complex hypersurfaces*, Ann. of Math. Studies, 61, Princeton, 1968.
- [4] S. P. NOVIKOV, Topology of foliations, *Trudy Moskov. Mat. Obsč.*, 14 (1965), 248-278, *A.M.S. Transl.*, 1967, 286-304.
- [5] G. REEB, *Sur certaines propriétés topologiques des variétés feuilletées*, Act. Sci. Ind., No. 1183, Hermann, Paris, 1952.
- [6] B. L. REINHART, Line elements on the torus, *Amer. J. Math.*, 81 (1959), 617-631.
- [7] E. SILBERSTEIN, Multifoliations on $M^n \times S^1$ where M^n is a stably parallelizable manifold, *Proc. London Math. Soc.*, (3), 35 (1977), 463-482.
- [8] I. TAMURA, Foliations and spinnable structures on manifolds, *Ann. Inst. Fourier*, 23 (1973), 197-214.
- [9] W. THURSTON, *Foliations of three-manifolds which are circle bundles*, Thesis, Univ. of California, Berkeley, 1972.
- [10] W. THURSTON, Non-cobordant foliations of S^3 , *Bull. Amer. Math. Soc.*, 78 (1972), 511-514.

Department of Mathematics,
University of Tokyo,
Hongo, Bunkyo-ku,
Tokyo, 113
Japan

Manuscrit reçu le 21 mars 1980.