

CAHIERS DE TOPOLOGIE ET GÉOMÉTRIE DIFFÉRENTIELLE CATÉGORIQUES

MICAH MCCURDY

ROSS STREET

What separable Fröbenius monoïdal functors preserve?

Cahiers de topologie et géométrie différentielle catégoriques, tome 51, n° 1 (2010), p. 29-50

http://www.numdam.org/item?id=CTGDC_2010__51_1_29_0

© Andrée C. Ehresmann et les auteurs, 2010, tous droits réservés.

L'accès aux archives de la revue « Cahiers de topologie et géométrie différentielle catégoriques » implique l'accord avec les conditions générales d'utilisation (<http://www.numdam.org/conditions>). Toute utilisation commerciale ou impression systématique est constitutive d'une infraction pénale. Toute copie ou impression de ce fichier doit contenir la présente mention de copyright.

NUMDAM

Article numérisé dans le cadre du programme
Numérisation de documents anciens mathématiques

<http://www.numdam.org/>

WHAT SEPARABLE FROBENIUS MONOIDAL FUNCTORS PRESERVE?

by *Micah McCURDY & Ross STREET*

Abstract

Separable Frobenius monoidal functors were defined and studied under that name by Kornél Szlachányi [14], [15], and by Brian Day and Craig Pastro [5]. They are a special case of the linearly distributive functors of Robin Cockett and Robert Seely [4]. Our purpose is to develop the theory of such functors in a very precise sense. We characterize geometrically which monoidal expressions are preserved by these functors (or rather, are stable under conjugation in an obvious sense). We show, by way of corollaries, that they preserve lax (meaning not necessarily invertible) Yang-Baxter operators, weak Yang-Baxter operators in the sense of [2], and (in the braided case) weak bimonoids in the sense of [12]. Actually, every weak Yang-Baxter operator is the image of a genuine Yang-Baxter operator under a separable Frobenius monoidal functor. Pre-bimonoidal functors are also defined and discussed.

Les foncteurs monoïdaux Frobenius séparables ont été définis et étudiés, sous ce nom, par Kornél Szlachányi [14], [15], et par Brian Day et Craig Pastro [5]. Ils sont un cas spécial des foncteurs linéaires entre catégories linéairement distributives, introduits par Robin Cockett et Robert Seely [4]. Notre objet est de développer la théorie de ces foncteurs en un sens très précis. Nous caractérisons géométriquement les expressions qui sont préservées par ces foncteurs (c'est-à-dire, sont stables sous conjugaison en un sens évident). Nous montrons sous forme de corollaire qu'ils préservent les opérateurs Yang-Baxter lax (non-nécessairement inversibles), les opérateurs Yang-Baxter faibles dans le sens de [2], et (dans le cas tressé) les bimonoides faibles dans le sens de [12]. En fait, chaque opérateur Yang-Baxter faible est une image d'un opérateur Yang-Baxter véritable par un foncteur Frobenius séparable. Les

foncteurs prébimonodaux sont aussi définis et discutés.

Mathematics Subject Classification: 18D10

Keywords: Frobenius monoidal functor, monoidal category, weak bimonoid, Yang-Baxter operator, separable Frobenius algebra, weak distributive law.

Dedicated to Francis Borceux on the occasion of his 60th birthday.

1 Introduction

Frobenius monoidal functors $F : \mathcal{C} \rightarrow \mathcal{X}$ between monoidal categories were defined and studied under that name in [14], [15] and [5] and in a more general context in [4]. If the domain \mathcal{C} is the terminal category 1 , then F amounts to a Frobenius monoid in \mathcal{X} . It was shown in [5] that Frobenius monoidal functors compose, so that, by the last sentence, they take Frobenius monoids to Frobenius monoids. We concentrate here on separable Frobenius F and show that various kinds of Yang-Baxter operators and (in the braided case) weak bimonoids are preserved by F .

We introduce prebimonoidal functors $F : \mathcal{C} \rightarrow \mathcal{X}$ between monoidal categories which are, say, braided. If the domain \mathcal{C} is the terminal category 1 , then any (weak) bimonoid in \mathcal{X} gives an example of such an F . We show that prebimonoidal functors compose and relate them to separable Frobenius functors.

2 Definitions

Justified by coherence theorems (see [8] for example), we write as if our monoidal categories were strict. A functor $F : \mathcal{C} \rightarrow \mathcal{X}$ between monoidal categories is *Frobenius* when it is equipped with a monoidal structure

$$\phi_{A,B} : FA \otimes FB \rightarrow F(A \otimes B) \quad \phi_0 : I \rightarrow FI,$$

and an opmonoidal structure

$$\psi_{A,B} : F(A \otimes B) \rightarrow FA \otimes FB \quad \psi_0 : FI \rightarrow I$$

such that

$$\begin{array}{ccc}
 F(A \otimes B) \otimes FC & \xrightarrow{\phi_{A \otimes B, C}} & F(A \otimes B \otimes C) \\
 \downarrow \psi_{A, B} \otimes 1 & & \downarrow \psi_{A, B \otimes C} \\
 FA \otimes FB \otimes FC & \xrightarrow{1 \otimes \phi_{B, C}} & FA \otimes F(B \otimes C) \\
 & & \downarrow \phi_{A, B \otimes C} \\
 FA \otimes F(B \otimes C) & \xrightarrow{\phi_{A, B \otimes C}} & F(A \otimes B \otimes C) \\
 \downarrow 1 \otimes \psi_{B, C} & & \downarrow \psi_{A \otimes B, C} \\
 FA \otimes FB \otimes FC & \xrightarrow{\phi_{A, B} \otimes 1} & F(A \otimes B) \otimes FC
 \end{array}$$

We shall call $F : C \rightarrow X$ *separable Frobenius monoidal* when it is Frobenius monoidal and each composite

$$F(A \otimes B) \xrightarrow{\psi_{A, B}} FA \otimes FB \xrightarrow{\phi_{A, B}} F(A \otimes B)$$

is the identity. We call $F : C \rightarrow X$ *strong monoidal* when it is separable Frobenius monoidal, $\phi_{A, B}$ is invertible, and ϕ_0 and ψ_0 are mutually inverse.

Suppose $F : C \rightarrow X$ is both monoidal and opmonoidal. By coherence, we have canonical morphisms

$$\phi_{A_1, \dots, A_n} : FA_1 \otimes \dots \otimes FA_n \longrightarrow F(A_1 \otimes \dots \otimes A_n)$$

and

$$\psi_{A_1, \dots, A_n} : F(A_1 \otimes \dots \otimes A_n) \longrightarrow FA_1 \otimes \dots \otimes FA_n$$

defined by composites of instances of ϕ and ψ . If $n = 0$ then these reduce to ϕ_0 and ψ_0 ; if $n = 1$, they are identities.

The *F-conjugate* of a morphism

$$f : A_1 \otimes \dots \otimes A_n \longrightarrow B_1 \otimes \dots \otimes B_m$$

in \mathcal{C} is the composite f^F :

$$\begin{array}{ccc}
 FA_1 \otimes \cdots \otimes FA_n & & FB_1 \otimes \cdots \otimes FB_m \\
 \searrow \phi_{A_1, \dots, A_n} & & \nearrow \psi_{B_1, \dots, B_m} \\
 F(A_1 \otimes \cdots \otimes A_n) & \xrightarrow{Ff} & F(B_1 \otimes \cdots \otimes B_m)
 \end{array}$$

in \mathcal{X} . For $m = 1$, this really only requires F to be monoidal while, for $n = 1$, this really only requires F to be opmonoidal. If a structure in \mathcal{C} is defined in terms of morphisms between multiple tensors, we can speak of the F -conjugate of the structure in \mathcal{X} . For example, we can easily see the well-known fact that the F -conjugate of a monoid, for F monoidal, is a monoid; dually, the F -conjugate of a comonoid, for F opmonoidal, is a comonoid. It was shown in [5] that the F -conjugate of a Frobenius monoid is a Frobenius monoid.

Notice that, for a separable Frobenius monoidal functor F , we have $\phi_n \circ \psi_n = 1$ for $n > 0$.

Suppose \mathcal{C} and \mathcal{X} are braided monoidal. We say that a separable Frobenius monoidal functor $F : \mathcal{C} \rightarrow \mathcal{X}$ is *braided* when the F -conjugate of the braiding $c_{A,B} : A \otimes B \rightarrow B \otimes A$ in \mathcal{C} is equal to $c_{FA,FB} : FA \otimes FB \rightarrow FB \otimes FA$ in \mathcal{X} . Because of separability, it follows that F is braided as both a monoidal and opmonoidal functor.

A *lax Yang-Baxter (YB) operator* on an object A of a monoidal category \mathcal{C} is a morphism $y : A \otimes A \rightarrow A \otimes A$ satisfying the condition

$$(y \otimes 1) \circ (1 \otimes y) \circ (y \otimes 1) = (1 \otimes y) \circ (y \otimes 1) \circ (1 \otimes y)$$

A *Yang-Baxter (YB) operator* is an invertible lax YB-operator.

Recall that the Cauchy (idempotent splitting) completion QC of a category \mathcal{C} is the category whose objects are pairs (A, e) where $e : A \rightarrow A$ is an idempotent on A and whose morphisms $f : (A, e) \rightarrow (B, p)$ are morphisms $f : A \rightarrow B$ in \mathcal{C} satisfying $pfe = f$ (or equivalently $pf = f$ and $fe = f$). Note emphatically that the identity morphism of (A, e) is $e : (A, e) \rightarrow (A, e)$; in particular, this means the forgetful $QC \rightarrow \mathcal{C}$, $(A, e) \mapsto A$, is not a functor. If \mathcal{C} is monoidal then so is QC with $(A, e) \otimes (A', e') = (A \otimes A', e \otimes e')$ and unit $(I, 1)$.

A *weak Yang-Baxter operator* on A (compare [2]) in \mathcal{C} consists of an idempotent $\nabla : A \otimes A \longrightarrow A \otimes A$, and lax YB-operators $y : A \otimes A \longrightarrow A \otimes A$ and $y' : A \otimes A \longrightarrow A \otimes A$, subject to the following conditions:

$$\nabla \circ y = y = y \circ \nabla \quad (2.1)$$

$$\nabla \circ y' = y' = y' \circ \nabla \quad (2.2)$$

$$y \circ y' = \nabla = y' \circ y \quad (2.3)$$

$$(1 \otimes \nabla) \circ (\nabla \otimes 1) = (\nabla \otimes 1) \circ (1 \otimes \nabla) \quad (2.4)$$

$$(1 \otimes y) \circ (\nabla \otimes 1) = (\nabla \otimes 1) \circ (1 \otimes y), \quad (2.5)$$

$$(1 \otimes \nabla) \circ (y \otimes 1) = (y \otimes 1) \circ (1 \otimes \nabla). \quad (2.6)$$

Notice that Equations 2.1, 2.2 and 2.3 say that $y : (A \otimes A, \nabla) \longrightarrow (A \otimes A, \nabla)$ is a morphism with inverse y' in QC .

Suppose $(A, \mu : A \otimes A \longrightarrow A, \eta : I \longrightarrow A)$ and $(B, \mu : B \otimes B \longrightarrow B, \eta : I \longrightarrow B)$ are monoids in the monoidal category \mathcal{C} . Let a morphism $\lambda : A \otimes B \longrightarrow B \otimes A$ be given. The following conditions imply that $A \otimes B$ becomes a monoid with multiplication $A \otimes B \otimes A \otimes B \xrightarrow{1 \otimes \lambda \otimes 1} A \otimes A \otimes B \otimes B \xrightarrow{\mu \otimes \mu} A \otimes B$ and unit $I \xrightarrow{\eta \otimes \eta} A \otimes B$:

$$\lambda \circ (\mu \otimes 1_B) = (1_B \otimes \mu) \circ (\lambda \otimes 1_A) \circ (1_A \otimes \lambda), \quad (2.7)$$

$$\lambda \circ (1_A \otimes \mu) = (\mu \otimes 1_A) \circ (1_B \otimes \lambda) \circ (\lambda \otimes 1_B), \quad (2.8)$$

$$\lambda \circ (\eta \otimes 1_B) = 1_B \otimes \eta, \quad \lambda \circ (1_A \otimes \eta) = \eta \otimes 1_A. \quad (2.9)$$

These are the conditions for λ to be a *distributive law* [3]. A *weak distributive law* [13] is the same except that Equations 2.9 are replaced by:

$$(1 \otimes \mu) \circ (\lambda \otimes 1) \circ (\eta \otimes 1 \otimes 1) = (\mu \otimes 1) \circ (1 \otimes \lambda) \circ (1 \otimes 1 \otimes \eta). \quad (2.10)$$

In the monoidal category \mathcal{C} , suppose A is equipped with a multiplication $\mu : A \otimes A \longrightarrow A$ and a “switch morphism” $\lambda : A \otimes A \longrightarrow A \otimes A$. Supply $A \otimes A$ with the multiplication $A \otimes A \otimes A \otimes A \xrightarrow{1 \otimes \lambda \otimes 1} A \otimes A \otimes A \otimes A \xrightarrow{\mu \otimes \mu} A \otimes A$. Then a comultiplication $\delta : A \longrightarrow A \otimes A$ preserves multiplication when the following holds:

$$\delta \circ \mu = (\mu \otimes \mu) \circ (1 \otimes \lambda \otimes 1) \circ (\delta \otimes \delta). \quad (2.11)$$

Dually, if we start with δ and λ , define the comultiplication $A \otimes A \xrightarrow{\delta \otimes \delta} A \otimes A \otimes A \otimes A \xrightarrow{1 \otimes \lambda \otimes 1} A \otimes A \otimes A \otimes A$ on $A \otimes A$, and ask for μ to preserve comultiplication, we are led to the same Equation 2.11

In a braided monoidal category \mathcal{C} , a *weak bimonoid* (see [12]) is an object A equipped with a monoid structure and a comonoid structure satisfying Equation 2.11 (with $\lambda = c_{A,A}$) and the “weak unit and counit” conditions:

$$\varepsilon \circ \mu \circ (1 \otimes \mu) = (\varepsilon \otimes \varepsilon) \circ (\mu \otimes \mu) \circ (1 \otimes \delta \otimes 1) \tag{2.12}$$

$$\begin{aligned} &= (\varepsilon \otimes \varepsilon) \circ (\mu \otimes \mu) \circ \left(1 \otimes c_{A,A}^{-1} \otimes 1\right) \circ (1 \otimes \delta \otimes 1) \\ (1 \otimes \delta) \circ \delta \circ \eta &= (1 \otimes \mu \otimes 1) \circ (\delta \otimes \delta) \circ (\eta \otimes \eta) \tag{2.13} \\ &= (1 \otimes \mu \otimes 1) \circ \left(1 \otimes c_{A,A}^{-1} \otimes 1\right) \circ (\delta \otimes \delta) \circ (\eta \otimes \eta) \end{aligned}$$

A *lax Yang-Baxter (YB) operator* on a functor $T : \mathcal{A} \rightarrow \mathcal{C}$ into a monoidal category \mathcal{C} is a natural family of morphisms

$$y_{A,B} : TA \otimes TB \longrightarrow TB \otimes TA$$

satisfying the condition

$$\begin{array}{ccc} & TB \otimes TA \otimes TC & \xrightarrow{1 \otimes y} & TB \otimes TC \otimes TA & \\ & \nearrow y \otimes 1 & & \searrow y \otimes 1 & \\ TA \otimes TB \otimes TC & & & & TC \otimes TB \otimes TA \\ & \searrow 1 \otimes y & & \nearrow 1 \otimes y & \\ & TA \otimes TC \otimes TB & \xrightarrow{y \otimes 1} & TC \otimes TA \otimes TB & \end{array}$$

One special case is where $\mathcal{A} = 1$ so that T is an object of \mathcal{C} : then we obtain a lax YB-operator on the object T as above. Another case is where $\mathcal{A} = \mathcal{C}$ and T is the identity functor: each (lax) braiding c on \mathcal{C} gives an example with $y_{A,B} = c_{A,B}$.

Suppose $T : \mathcal{A} \rightarrow \mathcal{C}$ is a functor and $F : \mathcal{C} \rightarrow \mathcal{X}$ is a functor between monoidal categories. Suppose lax YB-operators y on T and z on FT are given. We define F to be *prebimonoidal relative to y and z* when it is monoidal and opmonoidal, and satisfies

$$\begin{array}{ccc}
 FTA \otimes FTB \otimes FTC \otimes FTD & \xrightarrow{1 \otimes z \otimes 1} & FTA \otimes FTC \otimes FTB \otimes FTD \\
 \uparrow \psi \otimes \psi & & \downarrow \phi \otimes \phi \\
 F(TA \otimes TB) \otimes F(TC \otimes TD) & & F(TA \otimes TC) \otimes F(TB \otimes TD) \\
 \downarrow \phi & & \uparrow \psi \\
 F(TA \otimes TB \otimes TC \otimes TD) & \xrightarrow{F(1 \otimes y \otimes 1)} & F(TA \otimes TC \otimes TB \otimes TD)
 \end{array}$$

When C and X are (lax) braided and T is the identity with $y_{A,B} = c_{A,B}$ and $z_{A,B} = c_{FA,FB}$, we merely say F is *prebimonoidal*. Such an F is bimonoidal when, furthermore, FI , with its natural monoid and comonoid structure, is a bimonoid. We were surprised not to find this concept in the literature, however, we have found that it was presented in preliminary versions of the forthcoming book [1], and in talks by the authors of the same.

3 Separable invariance and connectivity

We begin by reviewing some concepts from [9]. Progressive plane string diagrams are deformation classes of progressive plane graphs. Here we will draw them progressing from left to right (direction of the x -axis) rather than from down to up (direction of the y -axis). A tensor scheme is a combinatorial directed graph with vertices and edges such that the source and target of each edge is a word of vertices (rather than a single vertex). Progressive string diagrams Γ can be labelled (or can have valuations) in a tensor scheme \mathcal{D} : for a given labelling $v : \Gamma \rightarrow \mathcal{D}$, the labels on the edges (strings) γ of Γ are vertices $v(\gamma)$ of \mathcal{D} while the labels on the vertices (nodes) x of Γ are edges $v(x) : v(\gamma_1) \cdots v(\gamma_m) \rightarrow v(\delta_1) \cdots v(\delta_n)$ of \mathcal{D} where $\gamma_1, \dots, \gamma_m$ are the input edges and $\delta_1, \dots, \delta_n$ are the output edges of x read from top to bottom; see Figure 1 where $f = v(x)$, $A_1 = v(\gamma_1)$, $B_n = v(\delta_n)$, and so on. The free monoidal category $\mathcal{F}\mathcal{D}$ on a tensor scheme \mathcal{D} has objects words of vertices and morphisms progressive plane string diagrams labelled in \mathcal{D} ; composi-

tion progresses horizontally while tensoring is defined by stacking diagrams vertically.

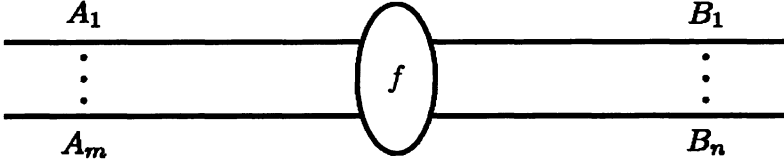

Figure 1:

Every monoidal category \mathcal{C} has an underlying tensor scheme: the vertices are the objects of \mathcal{C} and the edges from one word $A_1 \cdots A_m$ of objects to another $B_1 \cdots B_n$ is a morphism $f : A_1 \otimes \cdots \otimes A_m \rightarrow B_1 \otimes \cdots \otimes B_n$ in \mathcal{C} ; see Figure 1. When we speak of a labelling of a string diagram in \mathcal{C} we mean a labelling in the underlying tensor scheme; here we will simply call this a *string diagram in \mathcal{C}* . The value $v(\Gamma)$ of the string diagram $v : \Gamma \rightarrow \mathcal{C}$ is a morphism obtained by deforming Γ so that no two vertices of Γ are on the same vertical line then by horizontally composing strips of the form

$$1_{C_1} \otimes \cdots \otimes 1_{C_h} \otimes f \otimes 1_{D_1} \otimes \cdots \otimes 1_{D_k}.$$

Calculations in monoidal categories can be performed using string diagrams rather than the traditional diagrams of category theory. The value of Figure 1 is of course f . Figure 2 shows a string diagram $v : \Gamma \rightarrow \mathcal{C}$ whose value $v(\Gamma)$ is

$$\begin{array}{c}
 A_1 \otimes \cdots \otimes A_m \otimes D_1 \otimes \cdots \otimes D_q \\
 \downarrow f \otimes 1 \\
 B_1 \otimes \cdots \otimes B_n \otimes C_1 \otimes \cdots \otimes C_p \otimes D_1 \otimes \cdots \otimes D_q \\
 \downarrow 1 \otimes g \\
 E_1 \otimes \cdots \otimes E_p
 \end{array}$$

Now we return to our study of separable Frobenius monoidal functors.

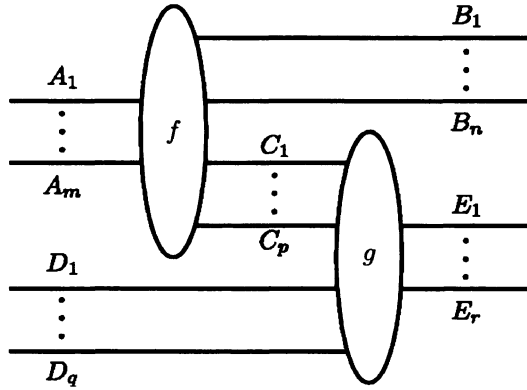

Figure 2:

Suppose $v : \Gamma \rightarrow \mathcal{C}$ is a string diagram in a monoidal category \mathcal{C} and $F : \mathcal{C} \rightarrow \mathcal{X}$ is a monoidal and opmonoidal functor. We obtain a *conjugate string diagram* $v^F : \Gamma \rightarrow \mathcal{X}$ in \mathcal{X} by defining

$$v^F(\gamma) = Fv(\gamma) \text{ and } v^F(x) = v(x)^F$$

for each edge γ and each node x of Γ . The conjugate of the string diagram in Figure 2 is shown in Figure 3. A (progressive plane) string diagram Γ is called *[separable] Frobenius invariant* when, for any labelling $v : \Gamma \rightarrow \mathcal{C}$ of Γ in any monoidal category \mathcal{C} and any [separable] Frobenius monoidal functor $F : \mathcal{C} \rightarrow \mathcal{X}$, the value of the conjugate diagram v^F in \mathcal{X} is equal to the conjugate of the value of v ; that is,

$$v^F(\Gamma) = v(\Gamma)^F. \tag{3.1}$$

As mentioned before, for a separable Frobenius monoidal functor F , we have $\phi_n \circ \psi_n = 1$ for $n > 0$.

The following two theorems characterize which string diagrams are preserved by Frobenius and separable Frobenius monoidal functors in terms of connectedness and acyclicity. Robin Cockett pointed out to us that similar geometric conditions occur in the work of Girard [7] and Fleury and Retoré ([6], §3.1). There may be a relationship with our results but the precise nature is unclear.

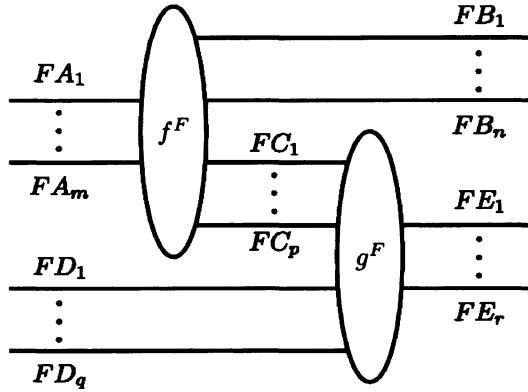

Figure 3:

Theorem 3.1. *A progressive plane string diagram is separable Frobenius invariant if and only if it is connected.*

Proof. In Figure 4, we show that Equation 3.1 holds for the string diagram $v : \Gamma \rightarrow C$ as in Figure 2, provided $p > 0$ (as required for Γ to be connected). To simplify notation we write FA for $F(A_1 \otimes \cdots \otimes A_m)$ and write A^F for $FA_1 \otimes \cdots \otimes FA_m$. We also leave out some tensor symbols \otimes . The second equality in Figure 4 is where separability, and the fact that the length p of the word C is strictly positive, are used; the third is where a Frobenius property is used.

Similarly, an obvious (horizontal) dual diagram to Figure 2 (look through the back of the page!) can be shown separably invariant. Furthermore, it is simple to show that diagrams of the form shown in Figure 5 are separably invariant, as well as their diagrams of the dual form.

By a similar proof to the above, such diagrams and their duals are separably invariant. Every connected string diagram can be constructed by iterating these four processes, this proves “if”. For “only if”, we exploit the fact that every string diagram can be interpreted in the terminal monoidal category 1 and that separable Frobenius monoidal functors $F : 1 \rightarrow C$ are precisely separable Frobenius algebras in C .

Suppose for a contradiction that a disconnected string diagram Γ with n input wires and m output wires is invariant under conjugation by such a

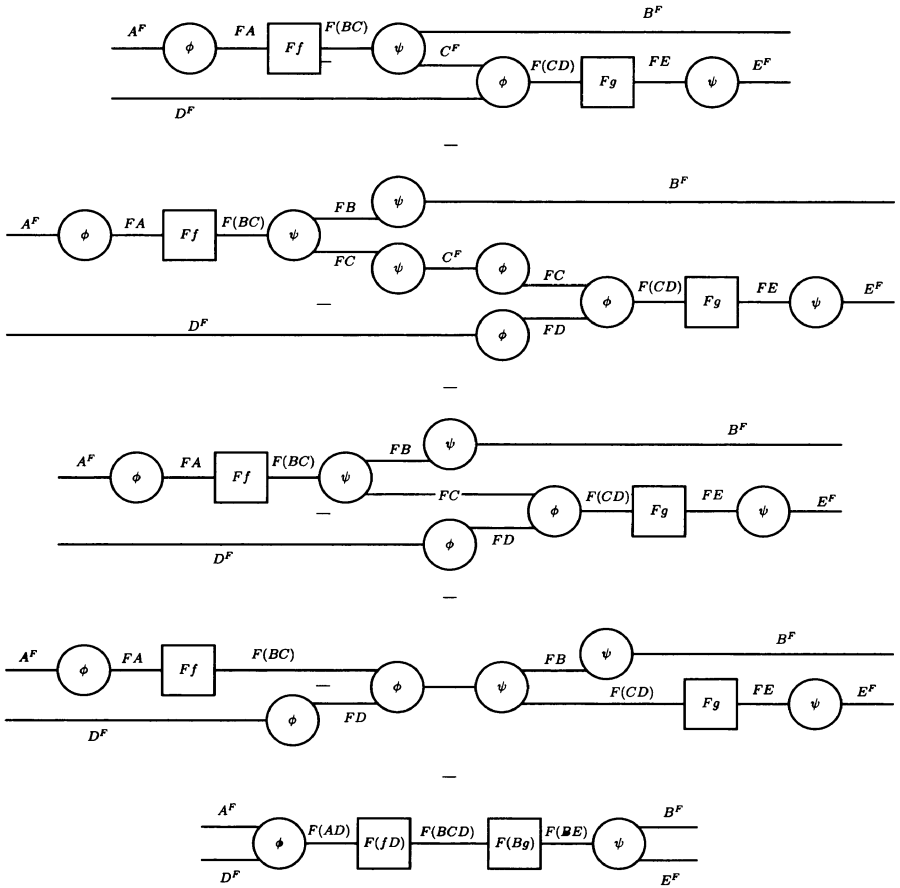

Figure 4:

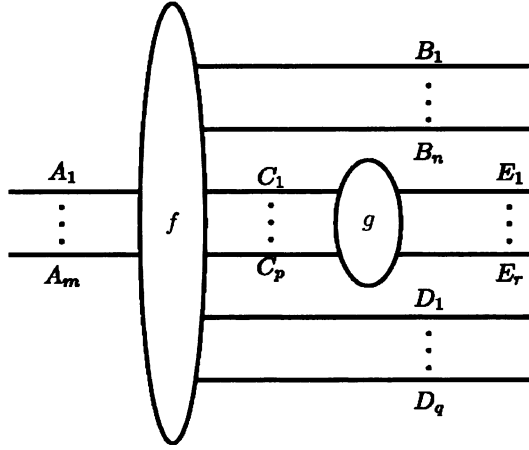

Figure 5:

separable Frobenius F , that is, a separable Frobenius algebra C . This asserts the equality of two morphisms $C^{\otimes n} \rightarrow C^{\otimes m}$, the first (obtained by taking the (trivial) value of the labelling in 1 and then applying F) is the composite of n -fold multiplication followed by m -fold comultiplication; the second (obtained by applying F to the labelling and then taking the value in C) is considerably more complicated, containing at least two connected components since Γ is assumed to be disconnected. By prepending n units and appending m counits, the first becomes the barbell of unit followed by counit; the latter becomes an endomap of the tensor unit of C with at least two connected components. If the tensor product of C is symmetric, this last simplifies to as many copies of the barbell as there are connected components of Γ ; hence, it suffices to find a separable Frobenius algebra for which the barbell does not equal any non-trivial power of itself.

We give two examples of such separable Frobenius algebras, a simple algebraic example and a more complicated geometric example. First, consider the complex numbers as a Frobenius algebra over the reals. Kock ([10], Example 2.2.14) notes that $\mathbb{C} \rightarrow \mathbb{R}$ given by $x + iy \mapsto ax + by$ is a Frobenius form on \mathbb{C} for all a and b not both zero. Choosing $a = 2, b = 0$ gives a *separable* Frobenius structure, and the “barbell” $\mathbb{R} \rightarrow \mathbb{C} \rightarrow \mathbb{R}$ is multiplication by 2, which does not equal any non-trivial power of itself. This completes

the proof of the converse of the theorem.

We sketch the construction of a more complicated but perhaps more pleasing, geometric example: consider the category **2Thick**, as described in [11], whose objects are finite disjoint unions of the interval (identified with the natural numbers), embedded in the plane, and whose morphisms are boundary-preserving-diffeomorphism classes smooth oriented surfaces embedded in the plane with boundary equal to the union of domain and codomain. For instance, Figure 6 shows a morphism in **2Thick** from 2 to 1. Lauda proves that **2Thick** is the free monoidal category containing a

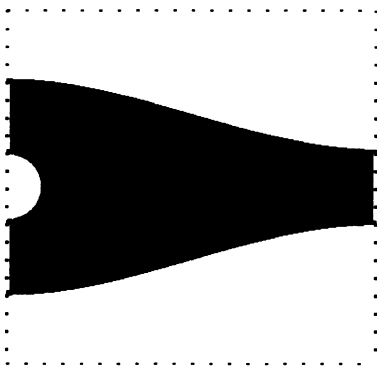

Figure 6: A morphism in **2Thick**

Frobenius algebra; the morphism from 2 to 1 shown in Figure 6 is the multiplication for this Frobenius algebra; the obvious similar map from 1 to 2 is the comultiplication. However, for this theorem, we require a *separable* Frobenius algebra, so we modify **2Thick** to obtain a category in which the equality in Figure 7 holds; in fact, we conjecture, to obtain the free monoidal category containing a separable Frobenius algebra. Specifically, instead of taking boundary-preserving diffeomorphism classes of morphisms, we say that two morphisms $k \rightarrow l$ are equal if there is a suitable 3-manifold M with corners which can be embedded in the unit cube in such that the intersection with the top face is the first morphism and the intersection with the bottom face is the second morphism. Here “suitable” means that the 3-manifold must be trivial on the domains and codomains k and l , and, crucially, the only critical points of the boundary of M permitted are “cups” –

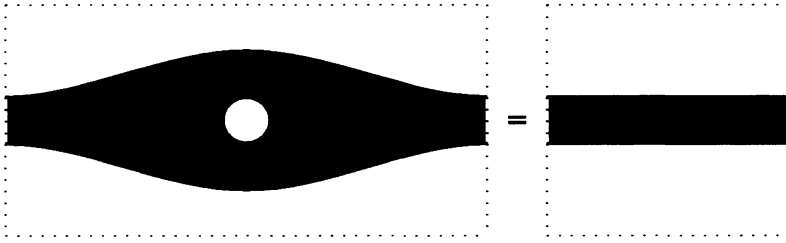

Figure 7:

that is, critical points which are not saddle points where the convex portion of the critical point lies *outside* the manifold M . There is an evident such “cup” which will witness the desired equality shown in Figure 7. Let us call this quotient of $\mathbf{2Thick}$ by the name $\mathbf{2Thick}'$.

Most importantly, it is clear that no two morphisms with different numbers of connected components can be identified by this equivalence relation, so any disconnected string diagram will fail to be separably invariant with respect to the canonical separable Frobenius functor $1 \longrightarrow \mathbf{2Thick}'$. \square

What this implies is that separable Frobenius monoidal functors preserve equations in monoidal categories for which both sides of the equation are values of connected string diagrams. For example:

Corollary 3.2. *For $n > 1$, equations of the form:*

$$(a_n \otimes 1)(1 \otimes a_{n-1})(a_{n-2} \otimes 1) \cdots = (1 \otimes b_n)(b_{n-1} \otimes 1)(1 \otimes b_{n-2}) \cdots,$$

involving morphisms

$$a_1, \dots, a_n, b_1, \dots, b_n : A \otimes A \longrightarrow A \otimes A,$$

are stable under F -conjugation. In fact, for $n = 2$, Frobenius F will do.

The proof of Theorem 3.1 can be slightly modified to give the analagous result for merely Frobenius monoidal functors instead of separable Frobenius monoidal functors.

Theorem 3.3. *A progressive plane string diagram is Frobenius invariant if and only if it is connected and simply connected.*

Proof. We have noted that all connected string diagrams can be obtained as iterations of the constructions shown in Figures 2 and 5 and their duals, with the restriction that $p > 0$. All connected and simply connected string diagrams can be obtained in this way with the restriction that $p = 1$. The only step of the proof in Figure 4 (and also the corresponding proof for the case shown in Figure 5) which requires separability is the cancellation of $FC \xrightarrow{\psi} C^F \xrightarrow{\phi} FC$ to obtain the identity on FC ; since $p = 1$, we have $FC = C^F = FC_1$, and both of these maps are identities. Hence, the same proof will go through in this case, establishing “if”.

Conversely, suppose that Γ is a string diagram which is not connected and acyclic. By Theorem 3.1, we may assume that Γ is connected and therefore is not acyclic. Then for Γ to be invariant under the canonical Frobenius monoidal functor $1 \longrightarrow \mathbf{2Thick}$ described in [11] and referred to already in Theorem 3.1 would imply that there is a diffeomorphism between two 2-manifolds of different genus; this is not the case. \square

Corollary 3.4. *Weak bimonoids are preserved by braided separable Frobenius functors.*

Proof. Weak bimonoids satisfy Equations 2.11, 2.12, and 2.13 these equations are labelled versions of the following string-diagrams:

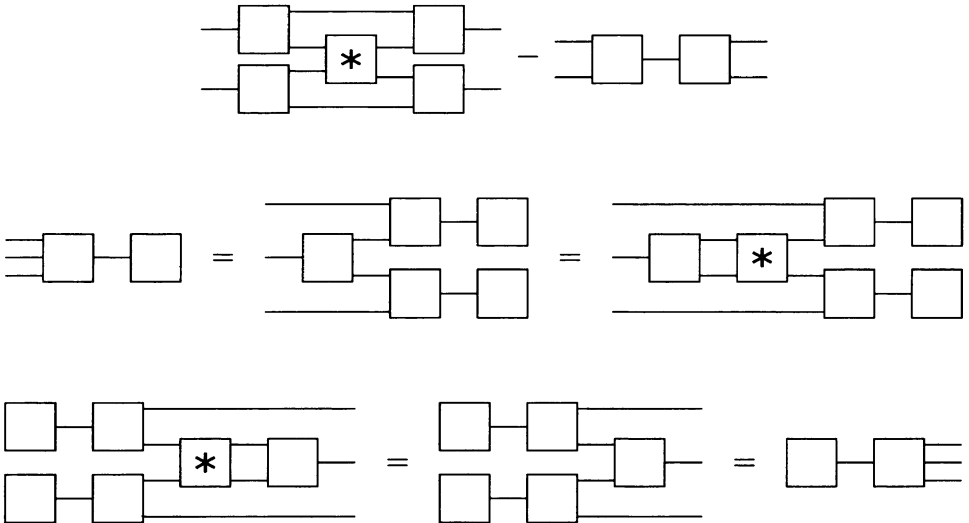

These are clearly connected and hence preserved by separable Frobenius functors. The asterisks indicate labellings by braids or their inverses, these are preserved by braided Frobenius functors. \square

However, genuine bimonoids are not preserved in general: the three unit and counit equations for a bimonoid involve non-connected string diagrams.

Corollary 3.5. *Weak distributive laws are preserved under F -conjugation.*

However, distributive laws are not preserved in general: the string diagrams for the right-hand sides of Equations 2.9 are not connected.

Corollary 3.6. *Lax YB-operators are preserved under F -conjugation.*

However, YB-operators are not preserved: invertibility involves an equation whose underlying diagram is a pair of disjoint strings and so is disconnected.

Corollary 3.7. *Weak YB-operators are preserved under F -conjugation. In particular, the F -conjugate of a YB-operator is a weak YB-operator.*

Proposition 3.8. *Every weak YB-operator in a monoidal category in which idempotents split is the conjugate of a YB-operator under some separable Frobenius monoidal functor.*

Proof. Let \mathcal{C} be a such a monoidal category containing an object D and an idempotent $\nabla : D \otimes D \longrightarrow D \otimes D$ such that $(\nabla \otimes 1)(1 \otimes \nabla) = (1 \otimes \nabla)(\nabla \otimes 1)$. Then there is an idempotent $\nabla_n : D^{\otimes n} \longrightarrow D^{\otimes n}$ recursively defined by:

$$\begin{aligned} \nabla_0 &= 1_I \\ \nabla_1 &= 1_D \\ \nabla_2 &= \nabla \\ \nabla_n &= (1 \otimes \nabla_{n-1}) \circ (\nabla \otimes 1) \quad \text{for } n > 2 \end{aligned}$$

Let $\mathcal{C}(D)$ be the subcategory of QC whose objects are the pairs $(D^{\otimes n}, \nabla_n)$ and whose morphisms $f : (D^{\otimes n}, \nabla_n) \rightarrow (D^{\otimes m}, \nabla_m)$ are those in QC for which:

$$(1 \otimes f)(\nabla_n \otimes 1) = (\nabla_m \otimes 1)(1 \otimes f) \tag{3.2}$$

$$(f \otimes 1)(1 \otimes \nabla_n) = (1 \otimes \nabla_m)(f \otimes 1). \tag{3.3}$$

The category $\mathcal{C}(D)$ becomes monoidal via

$$(D^{\otimes n}, \nabla_n) \otimes (D^{\otimes m}, \nabla_m) = (D^{\otimes(n+m)}, \nabla_{n+m}).$$

Note that this is not the same as the usual tensor product on QC which is inherited from that of \mathcal{C} . A weak Yang-Baxter operator on D in \mathcal{C} is a Yang-Baxter operator on D in $\mathcal{C}(D)$. Since idempotents split in \mathcal{C} then we have a functor $\mathcal{C}(D) \rightarrow \mathcal{C}$ taking each idempotent to a splitting. Moreover, this functor $\mathcal{C}(D) \rightarrow \mathcal{C}$ is separable Frobenius (although not strong) and so each weak YB-operator is the image of a genuine YB-operator.

Proposition 3.9. *Prebimonoidal functors compose.*

Proof. Suppose that $F : \mathcal{C} \rightarrow \mathcal{X}$ is prebimonoidal with respect to a YB-operator y on $T : \mathcal{A} \rightarrow \mathcal{C}$ and a YB-operator z on FT , and suppose further that $G : \mathcal{X} \rightarrow \mathcal{Y}$ is prebimonoidal with respect to z and a YB-operator a on GFT . Then the diagram in Figure 8 proves that GF is prebimonoidal with respect to y and a .

The diamonds commute by naturality of ϕ and ψ and the left and right pentagons commute by prebimonoidality of F and G , respectively. \square

Proposition 3.10. *If F is separable Frobenius then it is prebimonoidal relative to y and $z = y^F$.*

Proof. The proof is contained in Figure 9.

The five diamonds commute since F is Frobenius, and the two right-hand triangles commute since F is separable. The rhombus commutes by definition of y^F , the parallelograms by naturality of ϕ and ψ , and the two irregular cells are trivial. \square

Proposition 3.11. *A strong monoidal functor between braided monoidal categories is prebimonoidal if and only if it is braided.*

Proof. As noted above, strong monoidal functors are separable Frobenius, and strong monoidal functors are braided precisely when $c_{A,B}^F = c_{FA,FB}$, so Proposition 3.10 establishes “if”. Conversely, suppose that F is prebimonoidal with respect to the two braidings, and consider the commutative diagram in Figure 10.

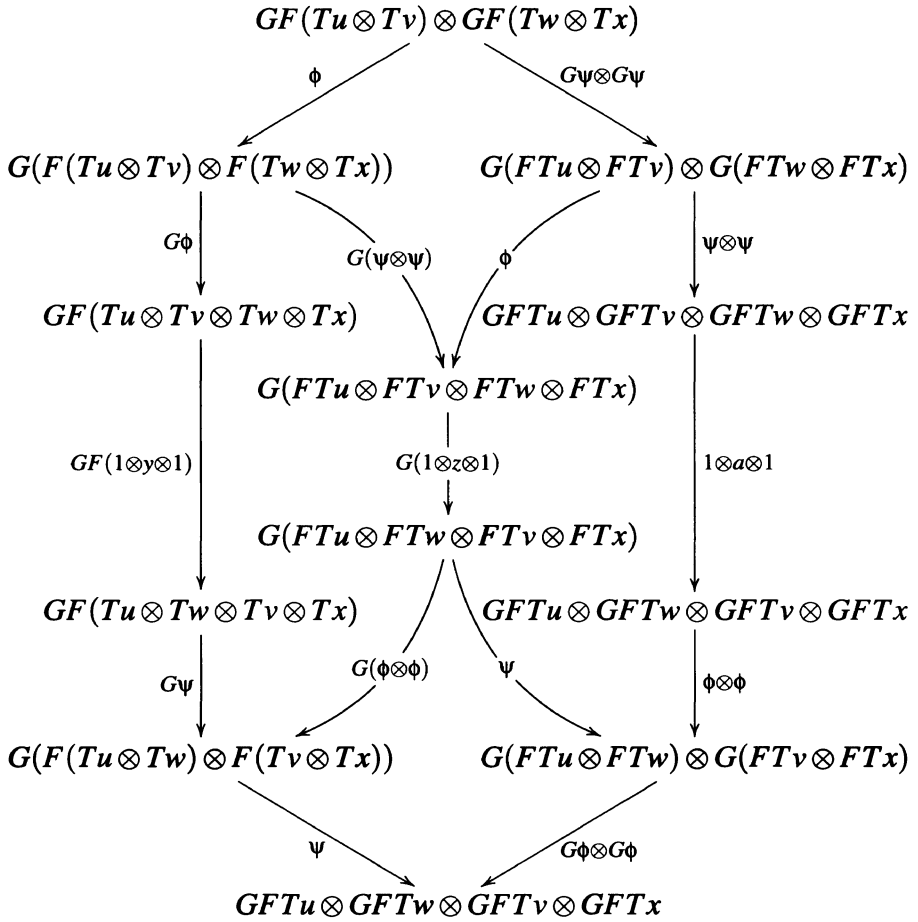

Figure 8: Proof of Proposition 3.9

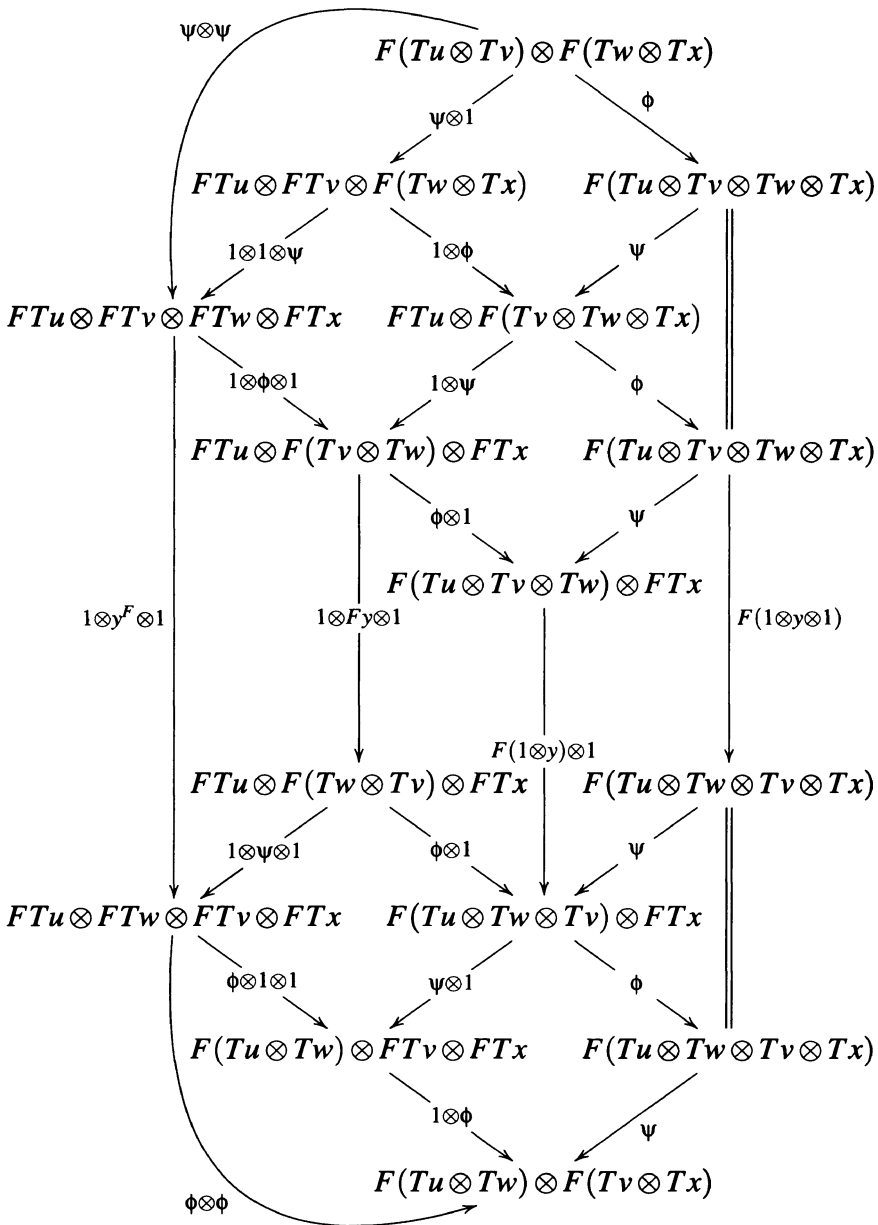

Figure 9: Proof of Proposition 3.10

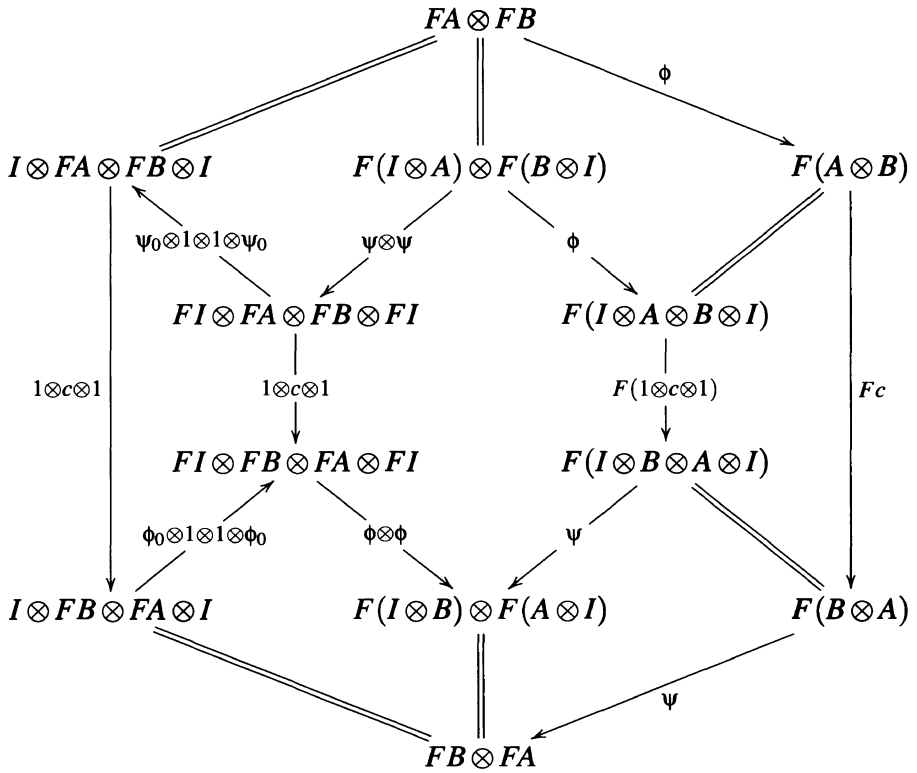

Figure 10: Proof of Proposition 3.11

The middle cell commutes since F is prebimonoidal, the bottom left since ϕ is monoidal, and the top left since ψ is opmonoidal. The three right-hand cells commute by definition, and, noting that ϕ_0 and ψ_0 are both natural and mutually inverse, the left-hand cell does so also. Hence, the full diagram shows that $c_{A,B}^F = c_{FA,FB}$, as desired. \square

References

- [1] M. Aguiar and S. Mahajan, Monoidal functors, species and Hopf algebras, preliminary copy available at <http://www.math.tamu.edu/~maguiar/a.pdf>
- [2] J. N. Alonso Álvarez, J. M. Fernández Vilaboa and R. González Rodríguez, Weak Hopf algebras and weak Yang-Baxter operators, *Journal of Algebra* **320** (2008), 2101–2143.
- [3] J. M. Beck, Distributive laws, *Lecture Notes in Mathematics* (Springer, Berlin) **80** (1969), 119–140.
www.tac.mta.ca/tac/reprints/articles/18/tr18abs.html
- [4] J. R. Cockett and R. A. Seely, Linearly distributive functors, *Journal of Pure and Applied Algebra* **143** (1999), 155–203.
- [5] B. J. Day and C. A. Pastro, Note on Frobenius monoidal functors, *New York Journal of Mathematics* **14** (2008), 733–742.
<http://arxiv.org/pdf/0801.4107v2>
- [6] A. Fleury and C. Retoré, The mix rule, *Mathematical Structures in Computer Science* **4** (1994), 273–285.
- [7] J.Y. Girard, Linear Logic, *Theoretical Computer Science* **50** (1987), 1–102.
- [8] A. Joyal and R. Street, Braided tensor categories, *Advances in Mathematics* **102** (1993), 20–78. MR **94m**:18008
- [9] A. Joyal and R. Street, The geometry of tensor calculus I, *Advances in Mathematics* **88** (1991), 55–112.

- [10] Kock J. Frobenius algebras and 2D topological quantum field theories. CUP, (2004)
- [11] A. Lauda, Frobenius algebras and planar open string topological field theories, (2005)
<http://arXiv.org/pdf/math/0508349>
- [12] C. Pastro and R. Street, Weak Hopf monoids in braided monoidal categories, *Algebra and Number Theory* **3** (2009), 149–207.
<http://pjm.math.berkeley.edu/ant/2009/3-2/index.xhtml>
- [13] R. Street. Weak distributive laws, *Theory and Applications of Categories* **22(12)** (2009), 313–320.
<http://www.tac.mta.ca/tac/volumes/22/12/22-12.pdf>
- [14] K. Szlachányi, Finite quantum groupoids and inclusions of finite type, *Fields Institute Communications* **30** (2001), 393–407.
- [15] K. Szlachányi, Adjointable monoidal functors and quantum groupoids, *Lecture Notes in Pure and Applied Mathematics* **239** (2005), 291–307.
<http://arXiv.org/pdf/math/0301253>

M. B. McCurdy, Macquarie University, NSW 2109, Australia

R. Street, Macquarie University, NSW 2109, Australia

The authors are grateful for the support of the Australian Research Council and Macquarie University.