

CAHIERS DE TOPOLOGIE ET GÉOMÉTRIE DIFFÉRENTIELLE CATÉGORIQUES

MARCO GRANDIS

On distributive homological algebra. III. Homological theories

Cahiers de topologie et géométrie différentielle catégoriques, tome
26, n° 2 (1985), p. 169-213

http://www.numdam.org/item?id=CTGDC_1985__26_2_169_0

© Andrée C. Ehresmann et les auteurs, 1985, tous droits réservés.

L'accès aux archives de la revue « Cahiers de topologie et géométrie différentielle catégoriques » implique l'accord avec les conditions générales d'utilisation (<http://www.numdam.org/conditions>). Toute utilisation commerciale ou impression systématique est constitutive d'une infraction pénale. Toute copie ou impression de ce fichier doit contenir la présente mention de copyright.

NUMDAM

Article numérisé dans le cadre du programme
Numérisation de documents anciens mathématiques
<http://www.numdam.org/>

ON DISTRIBUTIVE HOMOLOGICAL ALGEBRA.
III. HOMOLOGICAL THEORIES
by Marco GRANDIS

RÉSUMÉ. Nous construisons ici les modèles canoniques pour certaines théories (distributives) qui interviennent en Algèbre Homologique, telles que : complexe filtré, double complexe, objet différentiel filtré. Leurs catégories classifiantes peuvent être dessinées dans le plan, conduisant à un outil "graphique" pour l'étude des suites spectrales, et donnant des fondements précis aux diagrammes de Zeeman.

0. INTRODUCTION.

0.1. Part I of this work ⁽¹⁾ introduced RE-categories, i.e. ordered involutive categories generalizing the categories of relations on exact categories (in the sense of Puppe-Mitchell [18, 17]).

Part II studies RE-theories on a small graph Δ , proving that each one has a canonical (or generic, universal) model $t_0 : \Delta \rightarrow \underline{A}_0$ through which all the models factorize uniquely, and a classifying RE-category \underline{A}_0 determined up to isomorphism; EX-theories are also considered, as well as their i-canonical models and i-classifying exact categories (determined up to equivalence). Distributive and idempotent theories are particularly investigated, and criteria for recognizing their canonical models are given.

0.2. Here we study some theories of interest in homological algebra, as the (discrete or real) filtered complex, the double complex, the filtered differential object. These theories are distributive; they are also idempotent, except for the last one.

Their canonical model can be "drawn" in the (discrete or real) plane, as a sort of "crossword scheme" where the known information about an horizontal row reflects on the columns which cross it, and conversely. This allows to prove various results concerning the spectral systems of the above mentioned structures by a graphic method of investigation which we shall call "crossword chasing".

It could be useful to notice that, these theories being distributive, a RE-statement (II.2.5) concerning them needs only to be proved for one category of R-modules, where R is a non-trivial ring : e.g. for

¹⁾ Parts I and II appeared in this Journal [12, 13]. The reference I.m or I.m.n or I.m.n.p applies respectively to number m, or Section m.n or item (p) of Section m.n in Part I ; analogously for Part II.

abelian groups or for real vector spaces (II.6.10).

Distributive homological algebra, i.e., the study of distributive RE-theories, or equivalently of distributive EX-theories, appears to cover the domain of spectral sequences (except that for multiplicative structure); it also covers various "diagrammatic lemmata" (e.g. see 3.7) and some algebraic results as Jordan-Hölder decompositions (2.5-6). The study of non-trivial convergence for spectral sequences, however, requires a richer frame than RE-categories and RE-theories; it is deferred to future works.

0.3. This kind of graphic models was first considered by Zeeman [20] in 1957: he proves that, for a filtered differential group A which is "general", the (exact) category of subquotients of A generated by the filtration and the differential can be represented by suitable zones of the discrete plane and by partial bijections between them, so that various "operations" are preserved (e.g. unions and intersections of subobjects). The filtered complex is considered too (see also Hilton-Wylie [14]).

The algebraic system is assumed to be "general" (i.e., according to Zeeman, to present but *canonical* isomorphisms among its subquotients; according to our terminology, to be itself a canonical model) because the arrow of Zeeman's representation goes *from* the algebraic system to the diagram.

0.4. Subsequently, G. Darbo (unpublished seminars and courses, delivered in Genova from 1964) exposed a revised version of these ideas (yet not complete as regards proofs), in the following line.

The Zeeman diagram for the filtered complex can be organized into an exact ⁽²⁾ category \underline{E}_0 ; for each filtered complex (general or not) in any exact category \underline{E} it is possible to build an exact representation functor $F: \underline{E}_0 \rightarrow \underline{E}$, determined up to isomorphism. The exactness of F resumes all preservation properties considered by Zeeman, while the fact of reversing the representation allows to drop the condition of generality on the system to be represented: thus it becomes possible to formulate particular hypotheses on it and deduce consequences, via crossword chasing.

Incidentally, this frame practically coincides with the i -canonical model of the given EX-theory, in our formulation.

0.5. Later on ([9], 1981) the author gave a first proof (rather long and involved) for the i -canonical model of the filtered complex, based on a previous study of the categories of relations on exact categories, and induced relations in the distributive case ([7] and references therein).

²⁾ Exact categories were introduced by Puppe ([18], 1962) as *quasi-exact* categories, and successively called exact in Mitchell's book ([17], 1965). Their theory was not available to Zeeman in 1957.

0.6. The present formulation provides new results, among which : the existence of the canonical model for every theory (based on the strict completeness of the 2-category RE, Part I) ; the universality of L and L_0 for distributive and idempotent theories (Part II, based on the embedding theorems of [10]) ; the construction of the canonical model for the double complex (based on the Running Knot Theorem [11]).

It also offers simpler proofs, at the cost of a more developed general theory of canonical models (Part II), e.g. the introduction of canonical transfer models. However, the combinatorial checkings which still have to be done in order to prove that a given model is canonical are often heavy, and some further simplifications could be possible.

0.7. The outline of Part III is the following.

§1 studies models with values in the universal distributive (resp. idempotent) RE-category $L = \text{Rel}(J)$ (resp. $L_0 = \text{Rel}(J_0)$) already considered in II.6.

§2 and §3 show the canonical model for two simple idempotent theories : the bifiltered object and the sequence of morphisms. The first one yields a graphic proof of the Jordan-Hölder Theorem for exact categories, via crossword chasing (0.2).

§4 studies the canonical model for the canonically bounded filtered (chain) complex, an idempotent Hom-finite theory, and introduces its spectral sequence ; some applications via crossword chasing are given, like degeneracy and the Wang and Gysin exact sequences.

§5 supplies the canonical model for the real filtered chain complex, an idempotent theory, and considers the "partial homologies" E_{pqrs}^n, D_{pqrs}^n of Deheuvels [3], proving some exact sequences concerning them. Their limits are not studied here (0.2).

§6 introduces the canonical model for the double complex, and the two associated spectral sequences ; notice that these do not require the contracted complex (hence an abelian frame) to be considered.

Last, §7 shows some examples of non-idempotent theories, among which the filtered differential object.

0.8. Conventions. We follow the same conventions as in Parts I and II.

Moreover a model $t : \Delta \rightarrow \underline{A}$ of the theory T will be usually written here in a form of the following kind (more usual for "homological" theories) :

$$(1) \quad A_* = ((A_i, \partial^A)) : \Delta \rightarrow \underline{A}$$

where i varies in $\text{Ob}(\Delta)$, ∂ varies in $\text{Mor}(\Delta)$, $A_i = A_*(i)$ and $\partial^A = A_*(\partial)$. By abuse of notation we often write ∂ instead of ∂^A .

In a distributive RE-category, \mathbb{C} denotes the canonical preorder (domination) and Φ the associated congruence (I.7.4). In particular, in the distributive RE-category L_0 (II.6), for

$$(2) \quad a = (H, K ; L) : S_1 \rightarrow S_2, \quad a' = (H', K' ; L') : S_1 \rightarrow S_2$$

one has (II.6.5) :

$$(3) \quad a \subset a' \text{ iff } L \subset L', \quad a \Phi a' \text{ iff } L = L'.$$

Because of the epi-monic factorization of a in L_0 :

$$(4) \quad S_1 \xrightarrow{(H, L; L)} L \xrightarrow{(L, K; L)} S_2$$

we shall write $L = \text{Im}(a)$; L is a locally closed subspace of S_1 and S_2 .

0.9. Remark. The line we shall follow in § 2-6 to prove that a given model $t_0: \Delta \rightarrow \underline{A}_0$ of the RE-theory T is canonical (and T itself is idempotent) can be synthesized in this scheme.

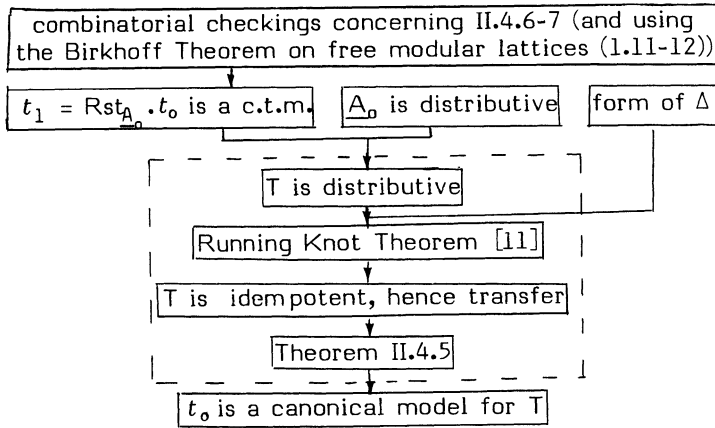

The part in the dotted rectangle will be shortened by using Criterion I or II for idempotent theories (II.5.3-4).

For non-idempotent theories this part has to be substituted by a direct argument proving that T is transfer (e.g. see 7.6, via 7.2).

1. MODELS IN L AND IN L_0 .

By II.6.9 every distributive (resp. idempotent) RE-theory has a canonical model $t_0: \Delta \rightarrow \underline{A}_0$, where \underline{A}_0 is a small Prj-full involutive subcategory of $L = \text{Rel}(\mathcal{J})$ (resp. of $L_0 = \text{Rel}(\mathcal{J}_0)$). We collect here various results concerning these models, to be used in the following numbers.

Δ is always a small graph, and every semitopological space is assumed to be small.

1.1. If Λ is a small subgraph of L , we write $L(\Lambda)$ the Prj-full involutive

subcategory of L spanned by Λ ; it is a sub-RE-category (I.5.7).

The objects of $L(\Lambda)$ are the ones of Λ ; if S and S' are so, a morphism $a \in L(S, S')$ is in $L(\Lambda)$ iff it is dominated in L by some a_0 in $L(S, S')$ which belongs to the involutive subcategory of L spanned by Λ .

Equivalently, $L(\Lambda)$ is the involutive subcategory of L spanned by those morphisms which are dominated by some Λ -morphism or by the identity of some Λ -object.

1.2. In the same way one defines the Prj-full involutive subcategory $L_o(\Lambda)$ of L_o , spanned by a small subgraph Λ of L_o .

Moreover, for a small non-empty set Σ of semitopological spaces, we write $L_o[\Sigma]$ the full subcategory of L_o having objects in Σ , and $L_o\langle\Sigma\rangle$ the full subcategory of L_o whose objects are locally closed subspaces of some object in Σ ; both are RE-subcategories of L_o , and we are going to prove (1.3) that $L_o\langle\Sigma\rangle$ is a concrete realization of the REX-category $\text{Fct}(L_o[\Sigma])$ associated to $L_o\langle\Sigma\rangle$ (I.3.5 ; I.6.5).

We also introduce

$$J_o\langle\Sigma\rangle = \text{Prp}(L_o\langle\Sigma\rangle).$$

1.3. Theorem. There is a (non-commutative) diagram of RE-functors :

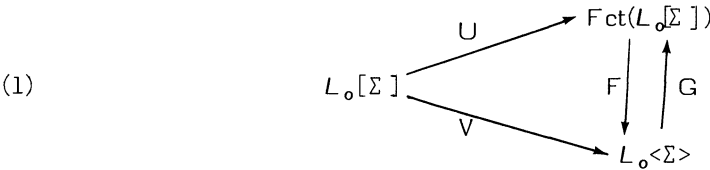

where U is the canonical embedding, V the inclusion and :

(2) $FU = V, \quad GV = U, \quad FG = 1, \quad GF \approx 1,$

(3) $F((H, H ; L) : S \rightarrow S) = L,$

(4) $F((H_1, K_1 ; L_1) : (H, H ; L) \rightarrow (H', H' ; L')) = ((H_1 \cap L, K_1 \cap L' ; L_1) : L \rightarrow L').$

Moreover, V satisfies the same i -universal problem as U (I.3.8). $J_o\langle\Sigma\rangle$ is an exact subcategory of J_o , and $\text{Rel}(J_o\langle\Sigma\rangle)$ is isomorphic to $L_o\langle\Sigma\rangle$.

Proof. First we prove that F is a functor. Let

$$\begin{aligned}
 e &= (H, H ; L) : S \rightarrow S, & e' &= (H', H' ; L') : S' \rightarrow S', \\
 e'' &= (H'', H'' ; L'') : S'' \rightarrow S''
 \end{aligned}$$

be projections of $L_o[\Sigma]$, hence objects of $\text{Fct}(L_o[\Sigma])$, and :

(5) $a = (H_1, K_1 ; L_1) : e \rightarrow e',$

(6) $b = (H_2, K_2 ; L_2) : e' \rightarrow e''$

be morphisms in $\text{Fct}(L_o[\Sigma])$. Notice that the condition $a\varepsilon = e$ is equivalent to $\underline{c}(a) < e$, hence to $\underline{def}(a) < \underline{n}(e)$, $\underline{ann}(a) > \underline{d}(e)$, i.e. :

$$(7) \quad H_1 \subset H; \quad H_1 - L_1 \supset H - L$$

and implies

$$(8) \quad L_1 \subset L; \quad H_1 - L = H - L.$$

Thus $F(a)$ is well defined in (4) : $H_1 \cap L$ is closed in L and L_1 is open in $H_1 \cap L$. F is a functor, since easy computations of compositions of relations in $L_o = \text{Rel}(J_o)$ give :

$$(9) \quad ba = ((H_1 - L_1) \cup (H_2 \cap L_1), (H_2 - L_2) \cup (H_1 \cap L_2); L_1 \cap L_2) : e \rightarrow e',$$

$$(10) \quad \begin{aligned} F(b).F(a) &= (H_2 \cap L', K_2 \cap L''; L_2). (H_1 \cap L, K_1 \cap L'; L_1) = \\ &= ((H_1 \cap L - L_1) \cup (H_2 \cap L_1), (H_2 \cap L' - L_2) \cup (H_1 \cap L_2); L_1 \cap L_2) = \\ &= (((H_1 - L_1) \cup (H_2 \cap L_1)) \cap L, ((H_2 - L_2) \cup (H_1 \cap L_2)) \cap L'; L_1 \cap L_2) = F(ba). \end{aligned}$$

F is clearly a RE-functor. It is faithful : if $a_o = (H_o, K_o; L_o) : e \rightarrow e'$ and $F(a_o) = F(a)$,

$$(11) \quad H_o \cap L = H_1 \cap L; \quad K_o \cap L' = K_1 \cap L'; \quad L_o = L_1;$$

moreover, by (8), $H - L = H_i - L$ for $i = 0, 1$; it follows that $H_o = H_1$; analogously $K_o = K_1$ and $a_o = a$.

Finally we build G . If L is a locally closed subspace of $S \in \Sigma$, choose two closed subsets $K \subset H$ of S so that $L = H - K$; then $G(L) = (H, H; L) : S \rightarrow S$ is an object of $\text{Fct}(L_o[\Sigma])$ and $F(G(L)) = L$. If

$$\bar{a} = (H_o, K_o; L_o) : L \rightarrow L'$$

is in $L_o < \Sigma >$ and $G(L') = (H', H'; L') : S' \rightarrow S'$, take $K' = H' - L'$ and :

$$(12) \quad G(\bar{a}) = (H_o \cup K, K_o \cup K'; L_o) : e \rightarrow e'$$

so that $FG(\bar{a}) = \bar{a}$.

As F is faithful, by the usual characterization of equivalence of categories it follows that G is a functor, and the pair is an equivalence (satisfying $FG = 1$) ; as F is a RE-functor, also G is such (1.5.5). It is easy to check that $FU = V$, $GV = U$.

Now, if $\varphi : F_1 \rightarrow F_2 : L_o[\Sigma] \rightarrow \underline{A}$ is a RE-transformation and \underline{A} a factorizing RE-category, by 1.3.8 there is a RE-transformation

$$\gamma : G_1 \rightarrow G_2 : \text{Fct}(L_o[\Sigma]) \rightarrow \underline{A}$$

extending φ via U ($\gamma U = \varphi$), uniquely determined by G_1 and G_2 . Let

$$\gamma' = \gamma G : G'_1 \rightarrow G'_2 : L_o < \Sigma > \rightarrow \underline{A} \quad (G'_i = G_i G);$$

then $\gamma' V = \gamma G V = \gamma U = \varphi$. Moreover, if $\gamma'' : G'_1 \rightarrow G'_2$ also verifies $\gamma'' V = \varphi$ it follows that

$$(13) \quad (\gamma'' F) U = \gamma'' V = \varphi = \gamma U$$

hence $\gamma'' F = \gamma$ and $\gamma'' = \gamma''(FG) = \gamma G = \gamma'$.

The last assertion in the statement is a straightforward consequence of Theorem I.6.1 : by the above equivalence, $L_o \langle \Sigma \rangle$ is factorizing ; trivially it is connected and non-empty.

1.4. Let T be an idempotent RE-theory on the small graph Δ , with canonical model $S_* : \Delta \rightarrow L_o[\Sigma]$.

The associated EX-theory T^e (II.7.3) determines, for every exact category \underline{E} , a category $T^e(\underline{E})$ whose objects $A_* : \Delta \rightarrow \text{Rel}(\underline{E})$ are the T-models in $\text{Rel}(\underline{E})$, and whose morphisms $u_* : A_* \rightarrow B_*$ are the RE-transformations of models.

According to II.7.4 and 1.3, the i-canonical model S'_* of T^e is the composition :

$$(1) \quad \Delta \xrightarrow{S_*} L_o[\Sigma] \longrightarrow L_o \langle \Sigma \rangle = \text{Rel} (J_o \langle \Sigma \rangle).$$

By II.7.6 this yields a global representation functor :

$$(2) \quad \text{Rpr} : J_o \langle \Sigma \rangle \times T^e(\underline{E}) \rightarrow \underline{E},$$

$$(3) \quad \text{Rpr}(L, A_*) = L(A_*) ; \quad \text{Rpr}(h, u_*) = h(u_*)$$

which is exact in the first variable.

1.5. Theorem (Union Rule). Let $F : \underline{L} \rightarrow \underline{A}$ be a RE-functor defined on a Proj-full involutive subcategory \underline{L} of \underline{L} . Let S be an object of \underline{L} and $e, e_i \in \text{Prj}_{\underline{L}}(S)$ (i varying in a small set I) with

$$(1) \quad e = (H, H ; L) \in L_o(S, S),$$

$$(2) \quad e_i = (H_i, H_i ; L_i) \in L_o(S, S),$$

$$(3) \quad L = \bigcup_{i \in I} L_i \quad (\text{set-union in } S^{(3)}).$$

Then

- a) $F(e)$ is null in \underline{A} iff all $F(e_i)$ are such,
- b) if (3) is a disjoint union and $F(e)$ is an atomic projection in \underline{A} (i.e., $F(e)$ is not null, and for every projection $f \triangleleft F(e)$ either $f = \overline{F}(e)$ or f is null, then there is exactly one $i_o \in I$ such that $F(e_{i_o})$ is not null ; moreover, if \underline{A} is distributive too, $F(e) \Phi F(e_{i_o})$, where Φ is the canonical congruence of \underline{A} .

Proof. We can always suppose that \underline{A} is distributive (otherwise, we replace F with F_1 , where $F = F_2 F_1$ is a RE-factorization (I.7.6)). Thus the canonical congruences Φ yield a functor

$$(4) \quad \overline{F} : \underline{L} / \Phi \rightarrow \underline{A} / \Phi$$

between inverse categories, which preserves distributive unions of projections : indeed, \overline{F} is a restriction of $\text{Rel}(\text{Prp}(\text{Fct}(\overline{F})))$ (I.6), the symmetrized functor of $F_o = \text{Prp}(\text{Fct}(\overline{F}))$ (componentwise exact), to which

3) Our result does not hold if L is just the least locally closed subset of S containing all the subsets L_i .

we apply [8], Theorem 6.3.

Now, by [8], § 1.4, 4.1, 5.3, the condition (3) says that the projection e of $\underline{L}_1 = \underline{L}/\Phi$ is the distributive union of the family (e_i) in the semilattice $\text{Prj}_{\underline{L}_1}(\underline{S})$; therefore $\overline{F(e)} = \overline{F(e)}$ is the distributive union of $(\overline{F(e_i)})_{i \in I}$ in $\text{Prj}_{\underline{A}/\Phi}(F(S))$.

_____ This proves a. Suppose now that (3) is a disjoint union, so that $\overline{F(e)}$ is the disjoint distributive union of $(\overline{F(e_i)})_{i \in I}$. The projection $\overline{F(e)}$ is atomic in \underline{A}/Φ : if $\overline{f} < \overline{F(e)}$, then consider $f' = F(e).f.F(e)$, so that $\overline{f'} = \overline{f}$ and $f' < F(e)$; since $F(e)$ is atomic in \underline{A} , by hypothesis, either $f' = F(e)$ or f' is null, and the conclusion follows. Therefore there exists exactly one $i_0 \in I$ such that $\overline{F(e_{i_0})}$ is not null, and $\overline{F(e)} = \overline{F(e_{i_0})}$: this proves b.

1.6. Lemma. let Z be a semitopological space, Σ a set of subspaces of Z , and Z' a subspace of Z such that all the traces $S' = S \cap Z'$ ($S \in \Sigma$) are different; call $\Sigma' = \{S \cap Z' \mid S \in \Sigma\}$ the trace of Σ on Z' .

Then there is a RE-quotient

- (1)
$$P : L_o[\Sigma] \rightarrow L_o[\Sigma'],$$
- (2)
$$P(S) = S' = S \cap Z',$$
- (3)
$$P((H, K ; L) : S_1 \rightarrow S_2) = ((H \cap Z', K \cap Z' ; L \cap Z') : S'_1 \rightarrow S'_2) =$$

$$= ((H \cap S'_1, K \cap S'_2 ; L \cap S'_1 \cap S'_2) : S'_1 \rightarrow S'_2).$$

Proof. P is obviously a RE-functor, bijective on the objects; we prove that it is full by using II.5.2.

First, P is Rst-full: if $S \in \Sigma$ and $e' = (H', H' ; H') : S' \rightarrow S'$ belongs to $\text{Rst}(S')$, then H' is closed in S' and $H' = H \cap S'$ for some H closed in S . Therefore $e' = P(e)$, where $e = (H, H ; H) : S \rightarrow S$ is a restriction of S . Last, let

$$a' = (H', K' ; L') : S'_1 \rightarrow S'_2$$

be a morphism in $L_o(\Sigma')$ with $S_j \in \Sigma$; L' is locally closed in S'_1 and S'_2 , hence $L' = \cup \cap H \cap S_1 \cap S_2$ where U is open and H is closed in S . Thus:

$$(4) \quad a = (H \cap S_1, H \cap S_2 ; \cup \cap H \cap S_1 \cap S_2) : S_1 \rightarrow S_2$$

is a morphism of $L_o[\Sigma]$ and, by 0.8.3,

$$a' \Phi P(a) = (H \cap S'_1, H \cap S'_2 ; \cup \cap H \cap S_1 \cap S_2).$$

1.7. Theorem (Deletion Rule). In the same hypotheses (concerning Z, Z', Σ, Σ'), let T be a theory having a canonical diagram

$$(1) \quad t_o : \Delta \rightarrow \underline{L} = L_o[\Sigma].$$

Then there is a theory T' on Δ whose models $t' : \Delta \rightarrow \underline{A}$ are precisely the models of T which "vanish outside Z' ", that is such that the factorization $t' = F t_o$ verifies

- (2) for every $S \in \Sigma$ and every $e = (H, H ; L) \in \text{Prj}_{\underline{L}}(S)$, if $L \cap Z' = \emptyset$ then $F(e)$ is null in \underline{A} .

Moreover T' has a canonical diagram "obtained by deleting $Z-Z'$ in t'_o ":

$$(3) \quad t'_o = Pt_o : \Delta \rightarrow \underline{L}' = L_o[\Sigma']$$

where P is the RE-quotient defined in 1.6.1-3.

Proof. It is easy to see that T' is a RE-theory.

Now $t'_o = Pt_o$ is a model of T , and of T' as well since for every projection $e = (H, H; L) : S \rightarrow S$ in \underline{L} ,

$$P(e) = (H \cap Z', H \cap Z'; L \cap Z') : S' \rightarrow S'$$

is null whenever $L \cap Z'$ is empty.

Moreover, if $t' : \Delta \rightarrow \underline{A}$ is a model of T' , it factorizes uniquely as $t' = Ft_o$, via t_o and a RE-functor F satisfying (2); by 1.8.4 and property (2) F factorizes uniquely through P

$$(4) \quad \begin{array}{ccccc} \Delta & \xrightarrow{t_o} & \underline{L} & \xrightarrow{F} & \underline{A} \\ & \searrow^{t'_o} & \downarrow P & \nearrow^{F'} & \\ & & \underline{L}' & & \end{array}$$

As t'_o is a q-morphism (hence right-cancellable), t' factorizes uniquely through t'_o .

1.8. We are mostly interested in semitopological spaces associated to ordered sets, in the following way.

If I is a totally ordered set, the subsets

$$(1) \quad]\leftarrow, i] = \{j \in I \mid j \leq i\} \quad (i \in I)$$

plus \emptyset and I will be the closed sets for the *order semitopology* of I . If $i_1 < i_2$ in I , the set

$$(2) \quad]i_1, i_2] = \{j \in I \mid i_1 < j \leq i_2\}$$

is locally closed.

Now if I and J are both totally ordered sets, the *product semitopology* on $S = I \times J$ has for closed sets

$$(3) \quad H = \bigcup_{r=1}^n (I_r \times J_r)$$

the finite unions of products of closed subsets of I and J . The set H has a unique not redundant expression (3).

This semitopology on $I \times J$ is less fine than the order topology (the closed subsets of which are those $H \subset I \times J$ such that $x \in H, y \in I \times J, y \leq x$ implies $y \in H$). However these semitopologies induce, on every finite subset of $I \times J$, the same topology.

1.9. We shall often use *locally closed rectangles* of $S = J \times J$:

$$(1) \quad L =]i_1, i_2] \times]j_1, j_2] = H_{i_2 j_2} - (H_{i_1 j_2} \cup H_{i_2 j_1}) \quad (i_1 < i_2, j_1 < j_2)$$

(2) $H_{ij} =]\leftarrow, i] \times]\leftarrow, j]$.

We say that the rectangles L and $L' =]i'_1, i'_2] \times]j'_1, j'_2]$ have *normal intersection* (or intersect normally) if there is exactly one L_0 -morphism $a : L \rightarrow L'$ having image $L \cap L'$. The latter will be called the *normal morphism from L to L'* ; it is clearly the greatest one (w.r.t. domination : 0.9). For example this happens when

(3) $i_1 \leq i'_1 < i'_2 \leq i_2 ; j'_1 \leq j_1 < j_2 \leq j'_2$,

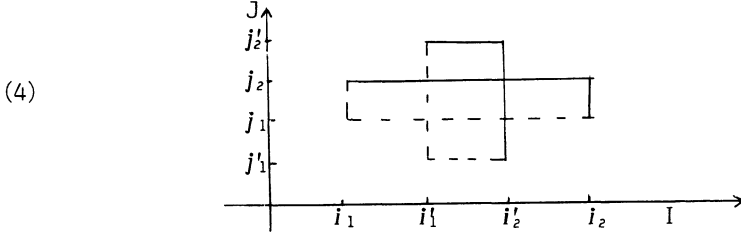

(5) $a = (]i_1, i_2] \times]j_1, j_2],]i'_1, i'_2] \times]j'_1, j'_2]) ; L \cap L' : L \rightarrow L'$,

(6) $\text{Def}(a) =]i_1, i'_2] \times]j_1, j_2] ; \text{Ann}(a) =]i_1, i'_1] \times]j_1, j_2]$,

(7) $\text{Val}(a) =]i'_1, i'_2] \times]j'_1, j'_2] ; \text{Ind}(a) =]i'_1, i'_2] \times]j'_1, j_1]$.

It also happens when

(8) $i_1 \leq i'_1 \leq i_2 \leq i'_2 ; j_1 \leq j'_1 \leq j_2 \leq j'_2$

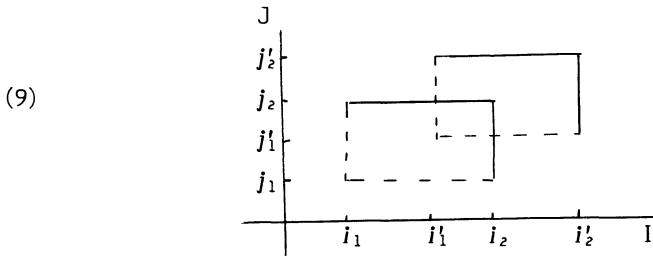

and the normal morphism is proper :

(10) $u = (L, L \cap L' ; L \cap L') : L \rightarrow L'$,

(11) $\text{Ker}(u) = L - L' ; \text{Im}(u) = L \cap L' ; \text{Cok}(u) = L' - L$.

We also remark that these considerations hold true in $L_0 \langle \Sigma \rangle$ whenever Σ is a set of subspaces of $S = I \times J$ and L, L' are contained in some subspace belonging to Σ .

1.10. A model of the theory T in the semitopological space S will be a model $t : \Delta \rightarrow \underline{L}$, where \underline{L} is a Prj-full involutive subcategory

of L whose objects are subspaces of S . In particular such a model will also be called a *discrete* (resp. *real*) *diagram* when S is $Z \times Z$ (resp. $R \times R$) with some semitopology : usually the product semitopology considered in 1.8, but not always (see 5.2 and 7.7).

For the discrete plane $Z \times Z$ we use a representation where the pair (ρ, q) corresponds to a unit square of the cartesian plane :

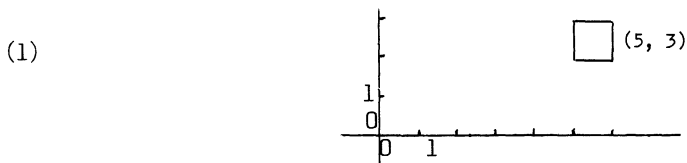

1.11. Theorem (Birkhoff). Let $\Lambda = I \cup J$ be an ordered set which is the union of two *chains* I, J (totally ordered sets) disjoint and not comparable. Let $I' = I \cup \{1\}$, $J' = J \cup \{1\}$ be these chains with a greatest element added.

The free modular 0, 1-lattice generated by Λ is the lattice of closed sets of the semitopological space $S = I' \times J'$ (with the product semitopology described in 1.8), via the embedding $\rho : \Lambda \rightarrow \text{Cls}(S)$:

(1) $\rho(i) =]\leftarrow, i] \times J'$ ($i \in I$),

(2) $\rho(j) = I' \times]\leftarrow, j]$ ($j \in J$).

In particular this lattice is distributive ; it is finite iff I and J are such.

Proof. When I and J are finite, this statement is just a theorem of Birkhoff ([1], page 66). Otherwise, let $f : \Lambda \rightarrow X$ be an increasing mapping with values in a modular 0, 1-lattice X and set $f(1) = 1_X$. For the closed subset H of S (with $i \in I', j \in J'$) :

(3) $H = \bigcup_{r=1}^n (]\leftarrow, i_r] \times]\leftarrow, j_r])$,

let

(4) $\bar{F}(H) = \bigcup_{r=1}^n (f(i_r) \wedge f(j_r))$.

The mapping $\bar{F} : \text{Cls}(S) \rightarrow X$ is a homomorphism of 0, 1-lattices, since every (binary) union or intersection in $\text{Cls}(S)$ concerns finite subchains of I and J , and therefore it is preserved by \bar{F} because of the Birkhoff Theorem. Finally, \bar{F} is clearly the only homomorphism such that $\bar{F} \rho = f$.

1.12. Corollary. With the same hypotheses, let $\varphi, \psi : I' \rightarrow J'$ be increasing mappings with $\varphi \leq \psi$. Set :

(1) $S_0 = \{ (i, j) \in S \mid \varphi(i) \leq j \leq \psi(i) \}$

with the induced semitopology. Consider also the mapping $\rho_0 : \Lambda \rightarrow \text{Cls}(S_0)$

(2) $\rho_0(i) = \rho(i) \cap S_0 = \{ (i', j') \in S \mid i' \leq i ; \varphi(i') \leq j' \leq \psi(i') \}$,

$$(3) \quad \rho_0(j) = \rho(j) \cap S_0 = \{ (i', j') \in S \mid \varphi(i') \leq j' \leq \min(j, \psi(i')) \}$$

and the order induced on $\Delta = \rho_0(\Lambda)$ by the order of inclusion in $\text{Cls}(S_0)$

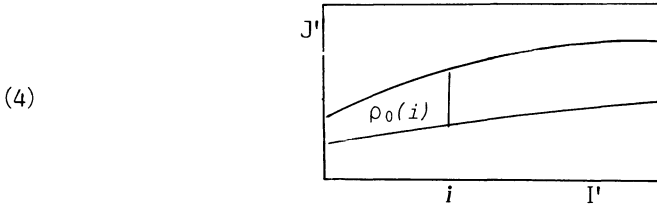

Then the (distributive) lattice $\text{Cls}(S_0)$ is the free modular 0, 1-lattice generated by the ordered set Δ .

Proof. It is easy to see that every (non empty) closed subset H of S_0 can be uniquely written as :

$$(5) \quad H = \bigcup_{r=1}^n (]\leftarrow, i_r] \times]\leftarrow, j_r]) \cap S_0$$

where the points $(i_r, j_r) \in S_0$ are not comparable ; the closure of H in S exists, and it is given by :

$$(6) \quad \bar{H} = \bigcup_{r=1}^n (]\leftarrow, i_r] \times]\leftarrow, j_r]).$$

Thus there is a retraction of lattices :

$$(7) \quad \text{Cls}(S_0) \xrightarrow{\kappa} \text{Cls}(S) \xrightarrow{\pi} \text{Cls}(S_0), \quad \pi\kappa = 1,$$

$$(8) \quad \kappa(H) = \bar{H}, \quad \pi(K) = K \cap S_0,$$

such that the upper part of the following diagram commutes

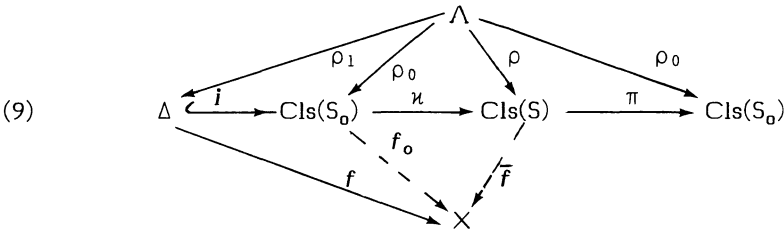

Now, let $f : \Delta \rightarrow X$ be an increasing mapping with values in a modular 0, 1-lattice ; then $f \rho_1 : \Lambda \rightarrow X$ is increasing, and by 1.11 there is a unique homomorphism $\bar{f} : \text{Cls}(S) \rightarrow X$ extending $f \rho_1$ via ρ ($\bar{f} \rho = f \rho_1$) ; therefore $f_0 = \bar{f} \kappa : \text{Cls}(S_0) \rightarrow X$ extends f via $i : \Delta \rightarrow \text{Cls}(S_0)$, as :

$$(10) \quad (f_0 i) \rho_1 = f_0 \rho_0 = \bar{f} \kappa \rho_0 = \bar{f} \rho = f \rho_1$$

and ρ_1 is epi. Conversely if f_0 is a homomorphism of 0, 1-lattices extending f via i , then :

$$(11) \quad (f_o\pi)\rho = f_o\rho_o = f_o i\rho_1 = f\rho_1,$$

that is $f_o\pi$ extends $f\rho_1$ via ρ , hence

$$f_o\pi = \bar{f} \quad \text{and} \quad f_o = f_o\pi\kappa = \bar{f}\kappa.$$

2. THE BIFILTERED OBJECT.

The theory of the bifiltered object has a simple canonical model, which can be useful in suggesting canonical models for more complicated theories. The canonical diagram can be used to give a graphic proof of the Jordan-Hölder Theorem for exact categories (2.5-6).

The sets $Z \times Z$, $R \times R$ or more generally $I \times J$ (where I and J are totally ordered sets) are always provided with the product semitopology (1.8); m and n are natural numbers.

2.1. The RE-theory of the (m, n) -bifiltered object ($m, n \in \mathbf{N}$) can be described as $T = T_\Delta$, where Δ is the RE-graph having one object, say 0, and two families

$$(1) \quad (e_i)_{i=1, \dots, m}, \quad (f_j)_{j=1, \dots, n}$$

of endomorphisms, with RE-conditions :

$$(2) \quad e_1 \leq e_2 \leq \dots \leq e_m = 1_0,$$

$$(3) \quad f_1 \leq f_2 \leq \dots \leq f_n = 1_0.$$

A model $A_* \in T(\underline{A})$ is given by an object $A = A_*(0)$ of \underline{A} with a bifiltration, namely two chains

$$(4) \quad e_i^A = A_*(e_i); \quad f_j^A = A_*(f_j) \quad (1 \leq i \leq m, \quad 1 \leq j \leq n)$$

in the modular lattice $Rst_\Delta(A)$. Of course this is equivalent to giving two chains in $Sub_{\underline{E}}(A)$, where $\underline{E} = Prp(Fct(\underline{A}))$.

2.2. Consider, now the (semi)topological space

$$(1) \quad S = [1, m] \times [1, n] \subset Z \times Z$$

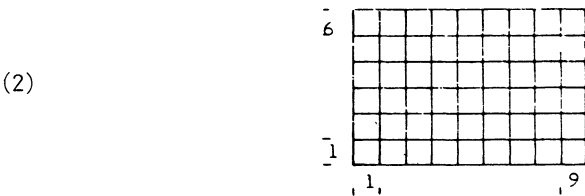

here pictured for $m = 9$ and $n = 6$, according to the representation 1.10.1.

2.3. Theorem. With these notations T has a discrete canonical diagram S_* described by (notations as in II.6 and n.1) :

- (1) $S_* : \Lambda \rightarrow L_0[S]$,
- (2) $S_*(0) = S$,
- (3) $S_*(e_i) = e_i^0 = (H_i, H_i; H_i) : S \rightarrow S$,
- (4) $S_*(f_j) = f_j^0 = (K_j, K_j; K_j) : S \rightarrow S$

where

- (5) $H_i = [1, i] \times [1, n]$, $K_j = [1, m] \times [1, j]$ ($1 \leq i \leq m$; $1 \leq j \leq n$).

The theory T is finite and idempotent.

Proof. Let $\underline{A}_0 = L_0[S]$; the lattice $\text{Rst}(S)$ is isomorphic to the lattice of closed subsets of S ; by the Birkhoff Theorem 1.11, $\text{Rst}(S)$ is the free modular 0, 1-lattice spanned by the chains $(e_i^0)_{1 \leq i < m}$, $(f_j^0)_{1 \leq j < n}$.

Thus $t_1 = \text{Rst}_{\underline{A}_0} S_*$ is a c.t.m. for T (II.4.6-7) and the conclusion follows from Criterion I (II.5.3) with $\Delta'' = \emptyset$; alternatively, one could use II.5.1-2.

2.4. The above result extends to (I, J) -bifiltrations, where I and J are *totally* ordered sets with a greatest element : the classifying RE-category is now $L_0[S]$, where $S = I \times J$ with the product semitopology (1.8). The theory is idempotent ; it is finite iff both I and J are such.

The more general theory of the Λ -filtered object, where Λ is a (partially) ordered set, will be considered in 7.8.

2.5. An application : the Jordan-Hölder Theorem for RE-categories. Let $A_* : \Delta \rightarrow \underline{A}$ be an (m, n) -bifiltered object in the RE-category \underline{A} , which we may assume distributive without restriction (2.3) and suppose that the projections

- (1) $\hat{e}_i = e_i^A / e_{i-1}^A$ ($1 \leq i \leq m$),
- (2) $\hat{f}_j = f_j^A / f_{j-1}^A$ ($1 \leq j \leq n$)

(where $e_0^A = f_0^A = \omega_A$) are atomic (1.5).

We want to prove that there exists a bijection between intervals of \mathbf{N} , $\varphi : [1, m] \rightarrow [1, n]$, such that the projections \hat{e}_i and $\hat{f}_{\varphi(i)}$ are Φ -equivalent ; in particular $m = n$.

Informally, just remark that the i -th column of S ,

$$\hat{H}_i = H_i - H_{i-1} = \{i\} \times [1, n]$$

is

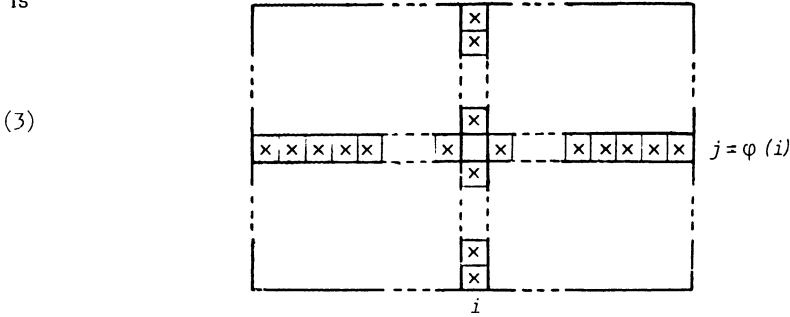

transformed into the atomic projection \hat{e}_i ; by the Union Rule 1.5 there is exactly one point (i, j) of H_i which is not annihilated in A_* . Analogously the j -th row $\hat{K}_j = K_j - K_{j-1} = [1, m] \times \{j\}$ contains exactly one point not annihilated in A_* . These points form the graph of our bijection φ .

More precisely, let $F : L_0[S] \rightarrow \underline{A}$ be the representative RE-functor of A_* ($A_* = FS_*$) and consider the projections

(3)
$$\hat{e}_i^0 = e_i^0 / e_{i-1}^0 = (H_i, H_i; \hat{H}_i) : S \rightarrow S \quad (1 \leq i \leq m),$$

(4)
$$\hat{f}_j^0 = f_j^0 / f_{j-1}^0 = (K_j, K_j; \hat{K}_j) : S \rightarrow S \quad (1 \leq j \leq n)$$

so that $F(\hat{e}_i^0) = \hat{e}_i$ and $F(\hat{f}_j^0) = \hat{f}_j$ are atomic in $\text{Rst}(A)$.

Consider also the "point" projections

(5)
$$g_{ij}^0 = (H_i \cap K_j, H_i \cap K_j; \{(i, j)\}) : S \rightarrow S.$$

As

(6)
$$\hat{H}_i = \bigcup_{j=1}^n \{(i, j)\}; \quad \hat{K}_j = \bigcup_{i=1}^m \{(i, j)\}$$

by the Union Rule 1.5 it follows that for every i (resp. j) there exists exactly one j (resp. i) such that $F(g_{ij}^0)$ is not null; moreover, if i and j are related in this one-to-one correspondence :

(7)
$$\hat{e}_i = F(\hat{e}_i^0) \Phi F(g_{ij}^0) \Phi F(\hat{f}_j^0) = \hat{f}_j.$$

2.6. The Jordan-Hölder Theorem for exact categories follows at once. Consider, for every exact category \underline{E} , the global representation functor (1.4) :

(1)
$$\text{Rpr} : J_0 \langle S \rangle \times T^e(\underline{E}) \rightarrow \underline{E}; \quad \text{Rpr}(L, A_*) = L(A_*).$$

Then, if $A_* : \Delta \rightarrow \text{Rel}(\underline{E})$ is a T^e -model of \underline{E} and for each i, j the subquotients

(2)
$$\hat{H}_i(A_*) = H_i(A_*) / H_{i-1}(A_*),$$

(3)
$$\hat{K}_j(A_*) = K_j(A_*) / K_{j-1}(A_*)$$

are atomic (i.e., *simple* objects of \underline{E}), there is a bijection

$$\varphi : [1, m] \rightarrow [1, n]$$

such that for each i , $\hat{H}_i(A_*)$ is canonically isomorphic [6] to $\hat{K}_{\varphi(i)}(A_*)$.

3. THE SEQUENCE OF MORPHISMS.

We consider the RE-theory of the sequence of morphisms ; an easy application yields the connecting homomorphism Lemma.

3.1. The RE-theory of the n -sequence of morphisms $T = T_\Delta$ is associated to the graph Δ :

$$(1) \quad 0 \xrightarrow{a_1} 1 \xrightarrow{a_2} 2 \xrightarrow{a_3} \dots \xrightarrow{a_n} n$$

with no RE-condition ⁽⁴⁾. A model $A_* : \Delta \rightarrow \underline{A}$ is just a sequence of (consecutive) morphism of \underline{A} :

$$(2) \quad A_0 \xrightarrow{a_1^A} A_1 \xrightarrow{a_2^A} A_2 \xrightarrow{a_3^A} \dots \xrightarrow{a_n^A} A_n .$$

3.2. Consider now the sets

$$(1) \quad S_k = [-n+k, n-k] \times [-k, k] \subset \mathbb{Z} \times \mathbb{Z} \quad (0 \leq k \leq n)$$

here represented for $n = 5$

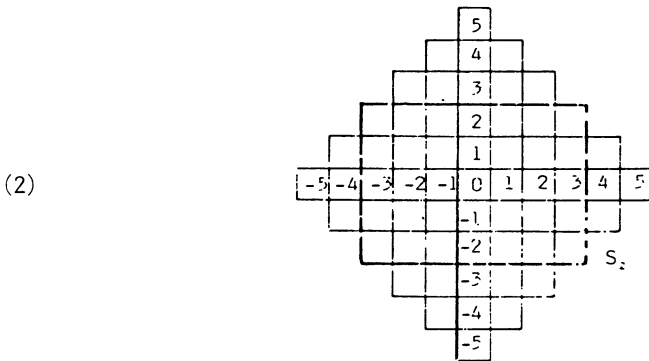

We also introduce the closed sets :

$$(3) \quad \bar{S}_k =]\leftarrow, n-k] \times]\leftarrow, k] \subset \mathbb{Z} \times \mathbb{Z} .$$

⁴⁾ Notice that the associated EX-theory T^e should be called the n -sequence of relations : indeed a model of T^e in the exact category \underline{E} is a sequence 3.1.2 of $\text{Rel}(\underline{E})$.

3.3. Theorem. The canonical model of the theory T (the n -sequence of morphisms) is the following discrete diagram ($\Sigma = \{ S_k \mid 0 \leq k \leq n \}$):

- (1) $S_* : \Delta \longrightarrow L_o[\Sigma],$
- (2) $S_*(k) = S_k \quad (0 \leq k \leq n),$
- (3) $S_*(a_k) = a_k = (S_{k-1} \cap \bar{S}_k, S_k \cap \bar{S}_{k-1}; S_{k-1} \cap S_k) : S_{k-1} \rightarrow S_k.$

The theory is idempotent and finite.

Proof. Let $\underline{A}_0 = L_o[\Sigma]$ and $t_o = S_* : \Delta \rightarrow \underline{A}_0$; we check the hypotheses of Criterion II (II.5.4) with

$$\Delta' = \emptyset, \quad \Delta'' = \Delta, \quad I = [0, n] \subset \mathbf{Z} \quad \text{and} \quad J = \{0\}.$$

The conditions (C.1, 2', 3, 4) hold trivially. (C 5) follows from the characterization of domination in L_o (0.9.3): every morphism

$$a = (H, K ; L) : S_h \rightarrow S_k$$

is dominated by the normal morphism

$$(4) \quad a_{hk} = (S_h \cap \bar{S}_k, S_h \cap \bar{S}_k ; S_h \cap S_k) : S_h \rightarrow S_k$$

and

$$(5) \quad a_{hk} = a_k \dots a_{h+1}, \quad \text{if } h < k,$$

$$(6) \quad a_{hk} = 1, \quad \text{if } h = k,$$

$$(7) \quad a_{hk} = \tilde{a}_{k+1} \dots \tilde{a}_h, \quad \text{if } h > k.$$

Last, for (C.6), we verify that

$$t_1 = \text{Rst}_{\underline{A}_0}.t_o : \Delta \rightarrow \text{Mlr}$$

is a canonical transfer model, via II.4.6.

The lattice $\text{Rst}(S_k) \simeq \text{Cls}(S_k)$ is, by the Birkhoff Theorem 1.11, the free modular 0, 1-lattice spanned by the chains :

$$(8) \quad e_i^k = (H_i^k, H_i^k ; H_i^k) : S_k \rightarrow S_k, \quad (-n+k \leq i < n-k)$$

$$(9) \quad f_j^k = (K_j^k, K_j^k ; K_j^k) : S_k \rightarrow S_k \quad (-k \leq j < k)$$

where

$$(10) \quad H_i^k = [-n+k, i] \times [-k, k], \quad (-n+k \leq i < n-k)$$

$$(11) \quad K_j^k = [-n+k, n-k] \times [-k, j] \quad (-k \leq j < k).$$

The condition II.4.6b is satisfied because :

$$(12) \quad e_i^k = \underline{\text{ann}}(a_{k,n+i+1}) = (a_{n+i+1,k})_R(\omega), \quad \text{for } -n+k \leq i < 0$$

$$(13) \quad e_i^k = \underline{\text{def}}(a_{k,n-i}) = (a_{n-i,k})_R(1), \quad \text{for } 0 \leq i < n-k,$$

$$(14) \quad f_j^k = \underline{\text{ind}}(a_{-j-1,k}) = (a_{-j-1,k})_R(\omega), \quad \text{for } -k \leq j < 0$$

$$(15) \quad f_j^k = \underline{\text{val}}(a_{j,k}) = (a_{j,k})_R(1), \quad \text{for } 0 \leq j < k.$$

Now, for every model $A_* : \Delta \rightarrow \underline{A}$ and for every k ($0 \leq k \leq n$) there is a unique homomorphism of 0, 1-lattices :

$$(16) \quad \vartheta_k : \text{Rst}_{\underline{A}_0}(S_k) \rightarrow \text{Rst}_{\underline{A}}(A_k)$$

such that

$$(12') \quad \vartheta_k(e_{\frac{k}{i}}) = \underline{\text{ann}}(a_{k,n+i+1}^A), \quad -n+k \leq i < 0,$$

and so on ; obviously a_{hk}^A is defined like a_{hk} in (5)-(7).

Finally we have to check the consistency conditions II.5.6d ; the four formulas (12)-(15) produce eight cases ; one of these is pointed out explicitly below (for $-n+k \leq i \leq 0$) :

$$(17) \quad \begin{aligned} \vartheta_{k+1}((a_{k+1})_R(e_{\frac{k}{i}})) &= \vartheta_{k+1}((a_{k+1})_R(a_{k,n+i+1})^R(\omega)) = \\ &= \vartheta_{k+1}((a_{k+1})_R(a_{k+1})^R(a_{k+1,n+i+1})^R(\omega)) = \vartheta_{k+1}((e_i^{k+1} \wedge f_k^{k+1}) \vee f_{-k-1}^{k+1}) = \\ &= (\text{ann}(a_{k+1,n+i+1}^A) \wedge \text{val}(a_{k+1}^A)) \vee \text{ind}(a_{k+1}^A) = (a_{k+1})_R(a_{k+1})^R(a_{k+1,n+i+1})^R(\omega) \\ &= (a_{k+1})_R(a_{k,n+i+1}^A)^R(\omega) = (a_{k+1})_R \vartheta_k(e_{\frac{k}{i}}). \end{aligned}$$

3.4. The n -sequence of proper morphisms. It is the theory $T' = T_{\Delta'}$ where Δ' is the preceding graph Δ (3.1.1) with the following RE-conditions :

$$(1) \quad a_k \in \text{Prp } \Delta' \quad (1 \leq k \leq n).$$

The canonical model is now :

$$(2) \quad S'_* : \Delta \rightarrow L_o[\{S'_k\}],$$

$$(3) \quad S'_*(k) = S'_k = [-n+k, 0] \times [0, k] \subset Z \times Z \quad (0 \leq k \leq n),$$

$$(4) \quad S'_*(a_k) = (S'_{k-1}, S'_{k-1} \cap S'_k ; S'_{k-1} \cap S'_k) : S'_{k-1} \rightarrow S'_k,$$

here pictured for $n = 5$:

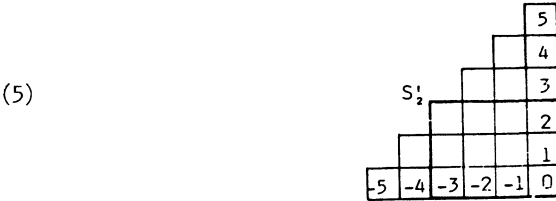

The proof can be direct, or derived from 3.3 and the deletion rule (1.7) : in this case remark that the models $A_* : \Delta \rightarrow \underline{A}$ of T' are those models of T such that, if $A_* = FS_*$ where S_* is the canonical model of T :

$$(6) \quad F((e_{\frac{k-1}{n-k}})^C) = F(\underline{\text{def}}^C(a_k)) = \underline{\text{def}}^C(a_k^A) = \omega \quad (1 \leq k \leq n),$$

$$(7) \quad F(f_{-k}^k) = F(\underline{ind}(a_k)) = \underline{ind}(a_k^A) = \omega \quad (1 \leq k \leq n),$$

so that we have to delete the following zone of $S = \mathbf{Z} \times \mathbf{Z}$ in S_* :

$$(8) \quad \begin{aligned} S - S' &= \bigcup_{k=1}^n ((S_{k-1} - H_{n-k}^{k-1}) \cup K_{-k}^k) = \\ &= \bigcup_{k=1}^n (\{n-k+1\} \times [-k, k] \cup [-n+k, n-k] \times \{-k\}). \end{aligned}$$

The result, according to 1.7, is just S'_* .

3.5. By further application of the deletion rule, one can derive the canonical model for the *order-two n-sequence* or for the *exact n-sequence* (of proper morphisms).

3.6. *The I-sequence of morphisms.* Our result (3.3) can be generalized to the theory $T = T_\Delta$ where Δ is now the order category associated to a totally ordered set I (without RE-conditions).

Let $I \rightarrow I^*$, $i \mapsto i^*$ be an anti-isomorphism of ordered sets, $I+I^*$ the totally ordered set obtained by "putting I before I^* " and

$$S = (I + I^*) \times (I^* + I)$$

the semitopological product (1.8); consider also the following locally closed subspaces of S :

$$(1) \quad S_i =]i, i^*] \times]i^*, i] \quad , \quad i \in I,$$

$$(2) \quad \bar{S}_i =]\leftarrow, i^*] \times]\leftarrow, i] \quad , \quad i \in I.$$

Then the canonical model of T is :

$$(3) \quad S_* : \Delta \rightarrow L_o[\{S_i\}] ,$$

$$(4) \quad S_*(i) = S_i ,$$

$$(5) \quad S_*(i \rightarrow j) = (S_i \cap \bar{S}_j , \bar{S}_i \cap S_j ; S_i \cap S_j) : S_i \rightarrow S_j .$$

The theory is idempotent.

3.7. *An application : the connecting homomorphism Lemma.* In the exact category \underline{E} , let be given the commutative diagram with exact rows :

$$(1) \quad \begin{array}{ccccccc} A & \xrightarrow{u} & B & \xrightarrow{v} & C & \longrightarrow & 0 \\ & & \downarrow f & & \downarrow g & & \downarrow h \\ 0 & \longrightarrow & A' & \xrightarrow{u'} & B' & \xrightarrow{v'} & C' \end{array}$$

As $u' \sim \ker_{\underline{E}}(v')$ and $v \sim \text{cok}_{\underline{E}}(u)$, the system is determined up to isomorphism by the sequence :

$$(2) \quad A \xrightarrow{u} B \xrightarrow{g} B' \xrightarrow{v'} C', \quad v'gu = 0.$$

This determines a RE-theory T contained in the theory of the 3-sequence of proper morphisms (3.4). According to the Deletion Rule 1.7, the canonical model of T is

$$(3) \quad A_0 \xrightarrow{u_0} B_0 \xrightarrow{g_0} B'_0 \xrightarrow{v'_0} C'_0,$$

$$(4) \quad \begin{array}{cccc} & & & 9 \\ & & & 8 \\ & & 7 & 8 \\ & 4 & 5 & 6 \\ 1 & 2 & 3 & \end{array}$$

(5) $A_0 = \{1, 2, 3\}$, $B_0 = \{2, 3, 4, 5, 6\}$, $B'_0 = \{3, 5, 6, 7, 8\}$, $C'_0 = \{6, 8, 9\}$ where u_0, g_0, v'_0 are proper normal morphisms.

Consider also the associated EX-theory T^e (1.4), and the following objects of the i -classifying exact category $J_0\langle\Sigma\rangle$:

- (6) $A'_0 = \text{Ker } v'_0 = \{3, 5, 7\}$, $C_0 = \text{Cok } u_0 = \{4, 5, 6\}$,
- (7) $K_1 = \text{Ker}(A_0 \rightarrow A'_0) = \{1, 2\}$, $K'_1 = \text{Cok}(A_0 \rightarrow A'_0) = \{5, 7\}$,
- (8) $K_2 = \text{Ker}(B_0 \rightarrow B'_0) = \{2, 4\}$, $K'_2 = \text{Cok}(B_0 \rightarrow B'_0) = \{7, 8\}$,
- (9) $K_3 = \text{Ker}(C_0 \rightarrow C'_0) = \{4, 5\}$, $K'_3 = \text{Cok}(C_0 \rightarrow C'_0) = \{8, 9\}$.

The exact sequence of proper normal morphisms (1.9) :

$$(10) \quad \{1, 2\} \rightarrow \{2, 4\} \rightarrow \{4, 5\} \rightarrow \{5, 7\} \rightarrow \{7, 8\} \rightarrow \{8, 9\}$$

yields, for the model (1) in \underline{E} , the exact sequence :

$$(11) \quad \text{Ker } f \rightarrow \text{Ker } g \rightarrow \text{Ker } h \xrightarrow{\partial} \text{Cok } f \rightarrow \text{Cok } g \rightarrow \text{Cok } h$$

where the proper morphism ∂ is induced by the relation $\tilde{u}'g\tilde{v} : C \rightarrow A'$. The sequence (11) is natural for translations of (1), by 1.4.

4. The canonically bounded filtered complex.

We study here the (canonically bounded) *filtered (chain) complex* [14, 15]. This theory is Hom-finite and idempotent ; it has a canonical model in the discrete plane.

We derive from this model a description and some standard properties of the associated spectral sequence, together with some applications via crossword chasing (0.2) : degeneracy, the Wang and Gysin exact sequences. More special applications, concerning transgressions in the spectral sequence of a space with operators, can be easily adapted from [4].

It is not difficult to build the canonical model for the more general theory of the (unrestricted) filtered complex [2]. However the study of non-trivial convergence requires a richer frame than that of RE-theories (0.2).

4.1. Consider the theory $T = T_\Delta$ defined by the RE-graph Δ having object-set \mathbf{N} and morphisms :

- (1) $\partial_n : n \rightarrow n-1 \quad (n > 0),$
 - (2) $f_p^n : n \rightarrow n \quad (-1 \leq p \leq n)$
- with RE-conditions :
- (3) $\partial_n \in \text{Prp } \Delta \quad (n > 0),$
 - (4) $\partial_n \partial_{n+1} \in \text{Nul } \Delta \quad (n > 0),$
 - (5) $f_p^n \leq f_{p+1}^n \quad (-1 \leq p < n),$
 - (6) $f_{-1}^n \in \text{Nul } \Delta, \quad f_n^n = 1,$
 - (7) $\partial_n f_p^n \leq f_p^{n-1} \partial_n \quad (-1 \leq p < n).$

4.2. A model $A_* : \Delta \rightarrow \underline{A}$ of the theory $T = T_\Delta$ is a *filtered (chain) complex* (with filtration canonically bounded by graduation), which we write :

(1) $A_* = ((A_n), (\partial_n), (f_p^n)) : \Delta \rightarrow \underline{A}$

with obvious abuses of notation (0.8).

On each term A_n there is a *bifiltration* (i.e., two chains of $\text{Rst}(A_n)$)

- (2) $\omega = f_{-1}^n \leq f_0^n \leq \dots \leq f_n^n = 1,$
- (3) $\omega = (\partial_{n+1})_R (f_{-1}^{n+1}) \leq (\partial_{n+1})_R (f_0^{n+1}) \leq \dots \leq (\partial_{n+1})_R (f_n^{n+1})$
 $\leq \partial_n^R (f_{-1}^n) \leq \partial_n^R (f_0^n) \leq \dots \leq \partial_n^R (f_{n-1}^n) = 1$

with conditions (following from 4.1.7) :

(4) $(\partial_{n+1})_R (f_p^{n+1}) \leq f_p^n \leq \partial_n^R (f_p^{n-1}) \quad (0 \leq p < n).$

4.3. This, together with other considerations pointed out elsewhere ([4], page 260), suggests to consider the subspaces S_n of $Z \times Z$ (with the product semitopology) :

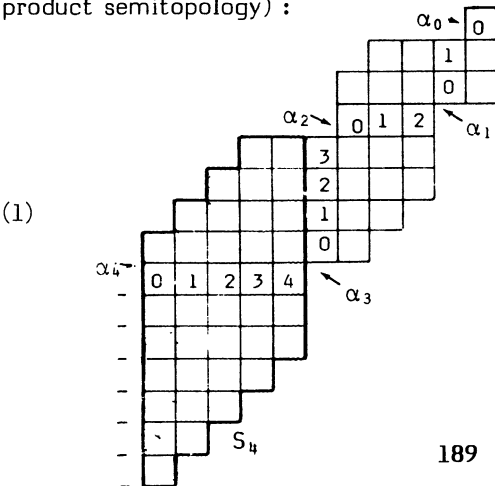

where S_n is defined as follows (α_0 is a point of $Z \times Z$, e.g., $(0, 0)$ and $\iota: Z \times Z \rightarrow Z \times Z$ is the interchange of coordinates):

- (2)
$$\alpha_n = \alpha_{n-1} - \iota^n(n+1, 1),$$
- (3)
$$S_n^0 = \{ (p, q) \in Z \times Z \mid 0 \leq p \leq n; -n+p-2 \leq q \leq \min(n, p+1) \},$$
- (4)
$$S_n = S_n + \iota^n(S_n^0)$$

so that S_n^0 is a sort of description of S_n by "local coordinates" with origin in α_n and suitable axes.

Consider also the T-model

- (5)
$$S_* : \Delta \rightarrow A_0 = L_0[\Sigma], \quad \text{with} \quad \Sigma = \{ S_n \mid n \geq 0 \} :$$
- (6)
$$S_*(n) = S_n,$$
- (7)
$$S_*(f_p^n) = \bar{f}_p^n = (F_p^n, F_p^n; F_p^n) : S_n \rightarrow S_{n-1},$$
- (8)
$$F_p^n = \alpha_n + \iota^n(S_n^0 \cap ([0, p] \times Z)), \quad -1 \leq p \leq n.$$

4.4. Theorem. The discrete diagram S_* is a canonical model for T, which is Hom-finite and idempotent.

Proof. We apply the Criterion II (II.5.4) with $t_0 = S_*$, $I = \mathbf{N}$, J a point and Δ' the subgraph of Δ having the same objects and morphisms f_p^n . The conditions (C.1, 2', 3, 4) hold trivially. For (C.5), notice that every morphism in $\underline{A}_0(S_n, S_m)$, with $n \geq m$, is dominated by:

- (1)
$$u_m^n = (S_n, S_n \cap S_m; S_n \cap S_m) : S_n \rightarrow S_m$$
- and
- $$u_m^n = 1 \text{ for } m = n, \quad u_m^n = \bar{\partial}_n \text{ for } m = n-1, \quad u_m^n = 0 \text{ otherwise.}$$

Finally we verify (C.6) via II.4.6-7). For each $n \geq 0$, $X_n = \text{Rst } \underline{A}_0(S_n)$ is (1.12) the free modular 0, 1-lattice generated by its ordered subset

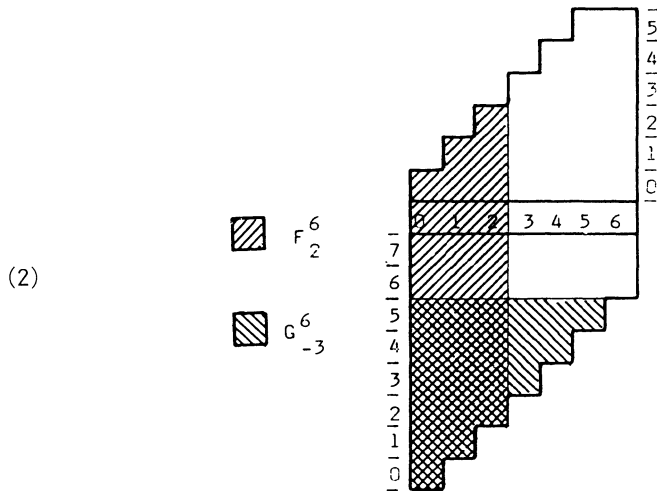

\times_n^0 containing the restrictions :

$$(3) \quad \bar{f}_p^n = (F_p^n, F_p^n; F_p^n) : S_n \rightarrow S_n \quad (0 \leq p < n),$$

$$(4) \quad \bar{g}_q^n = (G_q^n, G_q^n; G_q^n) : S_n \rightarrow S_n \quad (-n-2 \leq q < n),$$

$$(5) \quad G_q^n = \alpha_n + \iota^n(S_n^0 \cap (Zx]^+, q]).$$

Thus II.4.6 a holds, as well as II.4.6 b because

$$(6) \quad \bar{f}_p^n = (S_* f_p^n)_R(1) \quad (0 \leq p < n),$$

$$(7) \quad \bar{g}_q^n = (\bar{S}_*(\partial_{n+1} f_{n+2+q}^{n+1}))_R(1) \quad (-n-2 \leq q < 0),$$

$$(8) \quad \bar{g}_q^n = (\bar{S}_*(\tilde{\partial}_n f_{q-1}^{n-1}))_R(1) \quad (0 \leq q < n).$$

Now, the order relation on \times_n^0 is generated by :

$$(9) \quad \bar{f}_{p-1}^n \leq \bar{f}_p^n, \quad \bar{g}_{q-1}^n \leq \bar{g}_q^n \quad (0 < p < n, \quad -n-2 < q < n)$$

$$(10) \quad \bar{g}_{p-n-2}^n \leq \bar{f}_p^n \leq \bar{g}_{p+1}^n \quad (0 \leq p < n).$$

Therefore, for every model $A_* = ((A_n), (\partial_n), (f_p^n) : \Delta \rightarrow \underline{A}$ and each $n \geq 0$ the condition II.4.6 c is satisfied (4.2), and there is a unique 0, 1-lattice homomorphism $\vartheta_n : \text{Rst}(S_n) \rightarrow \text{Rst}(A_n)$ such that :

$$(11) \quad \vartheta_n(\bar{f}_p^n) = f_p^n \quad (0 \leq p < n),$$

$$(12) \quad \vartheta_n(\bar{g}_q^n) = (\partial_{n+1})_R(f_{n+2+q}^{n+1}) \quad (-n-2 \leq q < 0),$$

$$(13) \quad \vartheta_n(\bar{g}_q^n) = (\partial_n)^R(f_{q-1}^{n-1}) \quad (0 \leq q < n).$$

Finally we have to verify II.4.6 d. By II.4.7 the checking can be restricted to the morphisms ∂_m of Δ ; this leaves six formulas to prove. For simplicity we write down only the two related with the restriction f_p^n of S_n ($0 \leq p < n$) :

$$(14) \quad (\partial_n)_R(\vartheta_n \bar{f}_p^n) = (\partial_n)_R(f_p^n) = \vartheta_{n-1}(\bar{g}_{p-n-1}^{n-1}) = \vartheta_{n-1}((\bar{S}_*(\partial_n f_p^n))_R(1)),$$

$$(15) \quad (\partial_{n+1})^R(\vartheta_n \bar{f}_p^n) = (\partial_{n+1})^R(f_p^n) = \vartheta_{n+1}(\bar{g}_{p+1}^{n+1}) = \vartheta_{n+1}((\bar{S}_*(\tilde{\partial}_{n+1} f_p^n))_R(1)).$$

4.5. Consider now the following locally closed subspaces of S_n (hence objects of $\mathcal{J}_{0 < \Sigma}$), with $r \geq 0, p \geq 0, n = p+q$:

$$(1) \quad H_n = \alpha_n + \iota^n(\{0\} \times [0, n]) = \text{Ker } \bar{\partial}_n / \text{Im } \bar{\partial}_{n+1},$$

$$(2) \quad E_{p,q}^r = \alpha_n + \iota^n(S_n^0 \cap (\{p\} \times [\min(0, -n-2+p+r), \max(0, p+1-r)])),$$

$$(3) \quad E_{p,q}^r = E_{p,q}^\infty = \alpha_n + \iota^n(\{p, 0\}), \quad \text{for } r > \max(p, q+1),$$

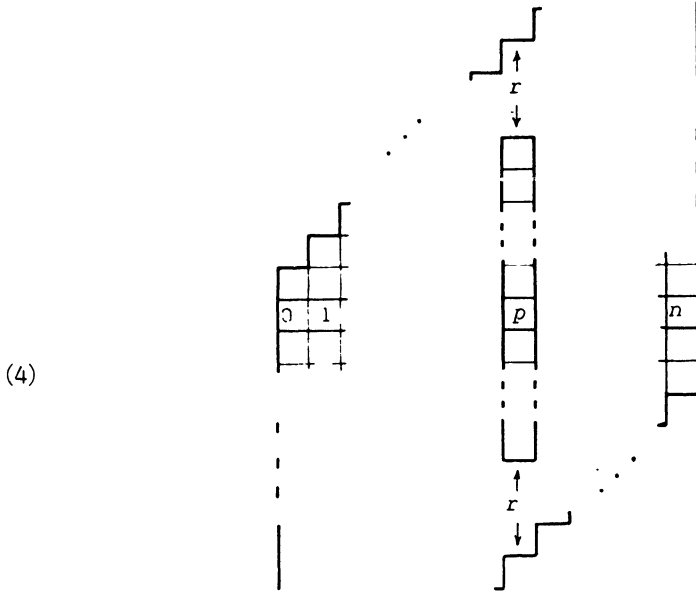

Notice that (assuming $F_p^n = \emptyset$ for $p < 0$) :

$$(5) \quad E_{pq}^0 = \alpha_n + \iota^n(S_n \cap (\{p\} \times \mathbb{Z})) = F_p^n / F_{p-1}^n.$$

Of course it is possible to obtain the object $E_{p,q}^r$ in the usual way :

$$(6) \quad E_{pq}^r = Z_{pq}^r / (Z_{p-1, q+1}^{r-1} \vee B_{pq}^{r-1}).$$

$$(7) \quad Z_{pq}^r = F_p^n \wedge \bar{\partial}_n^{-1}(F_{p-r}^{n-1}) = F_p^n \wedge G_{p+1-r}^n \quad (5)$$

$$(8) \quad B_{pq}^r = F_p^n \wedge \bar{\partial}_{n+1}(F_{p+r}^{n+1}) = F_p^n \wedge G_{n-2+p+r}^n \quad (5)$$

but we are not going to use here the terms Z_{pq}^r and B_{pq}^r .

4.6. Consider also the normal morphisms (1.9) of $J_0 \langle \Sigma \rangle$

$$(1) \quad \partial_{pq}^r = (E_{pq}^r, E_{pq}^r \cap E_{p-r, q+r-1}^r; E_{pq}^r \cap E_{p-r, q+r-1}^r) : E_{pq}^r \rightarrow E_{p-r, q+r-1}^r$$

and the order-two sequence :

$$(2) \quad E_{p+r, q-r+1}^r \xrightarrow{\partial_{p+r, q-r+1}^r} E_{pq}^r \xrightarrow{\partial_{pq}^r} E_{p-r, q+r-1}^r$$

⁵⁾ Here direct and inverse images of subobjects in the exact category $J_0 \langle \Sigma \rangle$ are written in the usual way. Moreover we assume that

$$G_q^n = \emptyset \quad \text{for } q < -n-2 \quad \text{and} \quad G_q^n = S_n \quad \text{for } q \geq n.$$

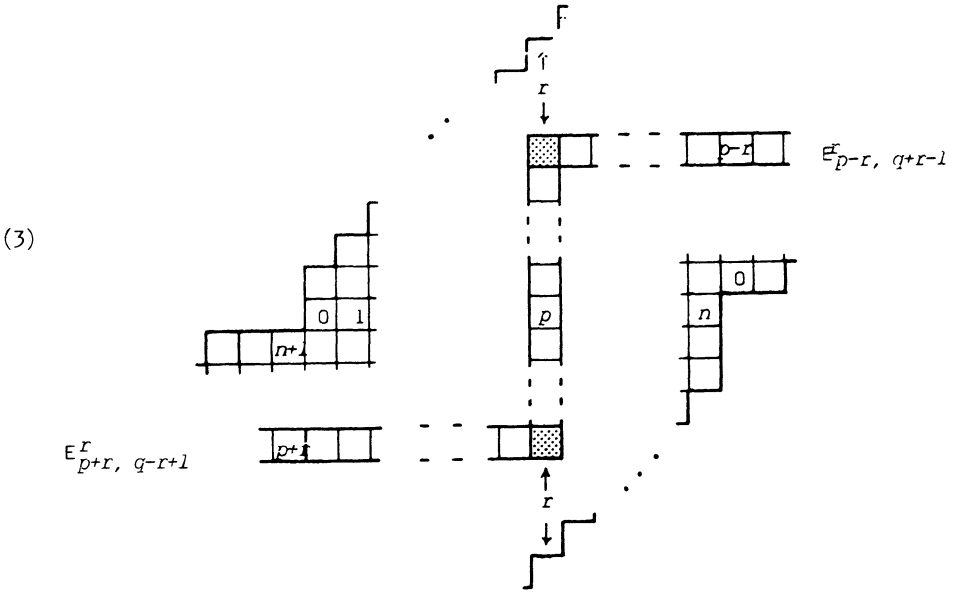

whose homology in $J_0<\Sigma>$ is clearly E_{pq}^{r+1} .

More generally consider the normal morphism of $L_0<\Sigma>= \text{Rel}(J_0<\Sigma>)$:

$$(4) \quad \partial : E_{p,q}^r \rightarrow E_{p',q'}^{r'} \quad (p'+q' = n-1)$$

which we call *generalized transgression* [14, 15] ; (4) is induced by $\partial_n : S_n \rightarrow S_{n-1}$ (see [6]).

We shall also use the normal morphisms :

$$(5) \quad E_{pq}^r \rightarrow E_{pq}^{r'} \quad (r \leq r') ; \quad E_{pq}^r \rightarrow H_{p+q}.$$

4.7. For every filtered complex $A_* : \Delta \rightarrow \text{Rel}(\underline{E})$ on the exact category \underline{E} , the global representation functor (1.4) yields the following objects and morphisms of \underline{E} (with obvious abuses of notation) :

$$(1) \quad H_n(A_*) = \text{Rpr}(H_n, A_*),$$

$$(2) \quad E_{pq}^r(A_*) = \text{Rpr}(E_{pq}^r, A_*),$$

$$(3) \quad E_{pq}^\infty(A_*) = \text{Rpr}(E_{pq}^\infty, A_*),$$

$$(4) \quad \partial_{pq}^r(A_*) = \text{Rpr}(\partial_{pq}^r, A_*) : E_{pq}^r(A_*) \rightarrow E_{p-r, q+r-1}^r(A_*)$$

still verifying the convergence property (4.5.3) and the homology

property (4.6), by the exactness of Rpr in the first variable.

The differential (4) is natural for morphisms of filtered complexes (since Rpr is a two-variable functor); instead, the generalized transgression

$$(5) \quad \partial(A_*) : F_{p,q}^r(A_*) \rightarrow F_{p',q'}^{r'}(A_*) \quad (p'+q' = p+q-1),$$

deriving from 4.6.4 via II.7.7, is not so, generally: every morphism $u_* : A_* \rightarrow B_*$ yields a RO-square

$$(6) \quad \begin{array}{ccc} E_{pq}^r(A_*) & \xrightarrow{E_{pq}^r(u_*)} & E_{pq}^r(B_*) \\ \partial(A_*) \downarrow & & \downarrow \partial(B_*) \\ E_{p'q'}^{r'}(A_*) & \xrightarrow{E_{p'q'}^{r'}(u_*)} & E_{p'q'}^{r'}(B_*) \end{array}$$

It should be noticed that, if $\partial(A_*)$ and $\partial(B_*)$ are proper morphisms, (6) is commutative (I.2.2); loosely speaking, *the generalized transgression ∂ is natural on those complexes on which it is proper*. Analogous properties hold for the morphisms 4.6.5.

4.8. Degeneracy. As it is well known, if the spectral sequence of $A_* : \Delta \rightarrow \text{Rel}(\underline{E})$ degenerates:

$$(1) \quad E_{pq}^2(A_*) = 0 \quad \text{for } p > 0,$$

the normal relation (4.6.5)

$$(2) \quad E_{on}^2(A_*) \rightarrow H_n(A_*)$$

is an isomorphism.

Actually, in the following diagram the unit squares which, according to (1), are annihilated by the representation functor F of A_* ($A_* = FS_*$) are marked with a cross or a point:

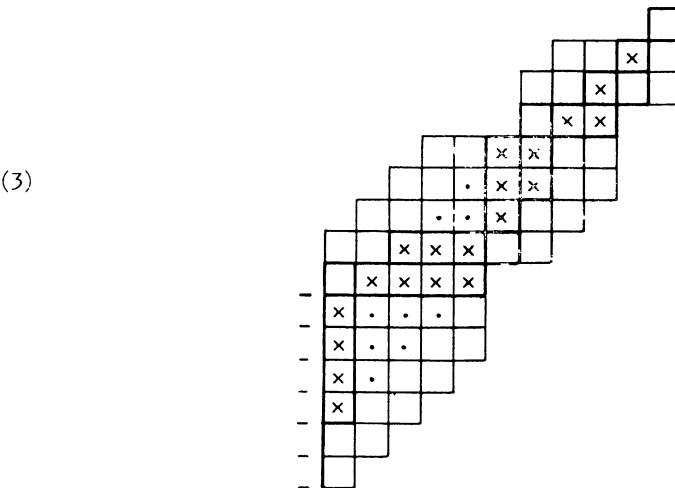

The crosses denote the "elementary annihilation conditions" which are necessary and sufficient to get the thesis, while the points denote redundant annihilation conditions ; in "degree n ", that is in S_n , there are $3n - 1$ "cross conditions" and $(n - 1)^2$ superfluous conditions.

4.9. *The Wang exact sequence* [14, 15, 19]. If in the spectral sequence of $A_* : \Delta \rightarrow \text{Rel}(\underline{E})$:

$$(1) \quad E_{pq}^2(A_*) = 0 \quad \text{for } p \neq 0, k,$$

there is an exact sequence of proper normal morphisms :

$$(2) \quad \begin{aligned} \dots \rightarrow H_n(A_*) \rightarrow E_{k,n-k}^2(A_*) \xrightarrow{\partial} E_{0,n-1}^2(A_*) \rightarrow H_{n-1}(A_*) \rightarrow \dots \\ \dots \rightarrow H_k(A_*) \rightarrow E_{k,0}^2(A_*) \xrightarrow{\partial} E_{0,k-1}^2(A_*) \rightarrow H_{k-1}(A_*) \rightarrow 0. \end{aligned}$$

Indeed the hypotheses give :

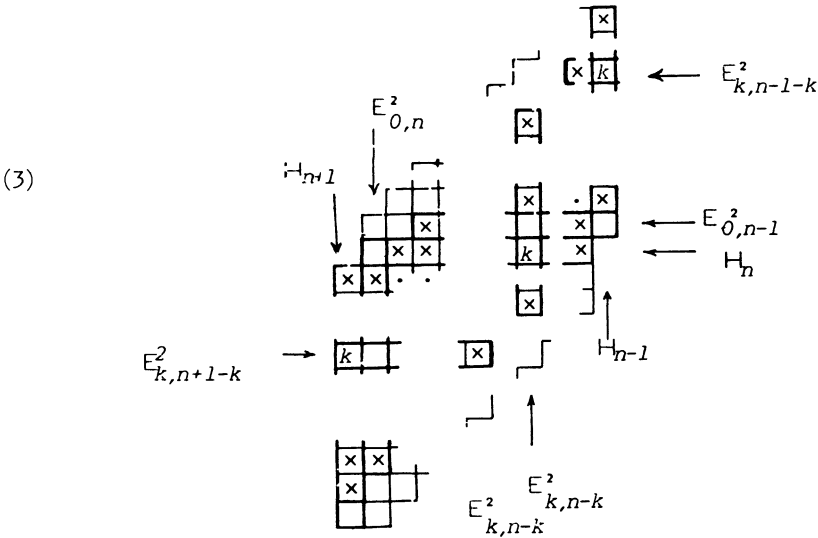

Moreover, by 4.7, the sequence is natural for morphisms of complexes satisfying (1).

4.10. *The Gysin exact sequence* [14, 15, 19]. If, in the spectral sequence of A_* :

$$(1) \quad E_{pq}^2(A_*) = 0 \quad \text{for } q \neq 0, k \quad (k > 1)$$

there is an exact sequence of (proper) normal morphisms :

$$(2) \quad \dots \rightarrow H_{n+1}(A_*) \rightarrow E_{n+1,0}^2(A_*) \xrightarrow{\partial} E_{n-k,k}^2(A_*) \rightarrow H_n(A_*) \rightarrow \dots$$

$$\cdot \dots \rightarrow H_{k+1}(A_*) \rightarrow E_{k+1,0}^2(A_*) \xrightarrow{\partial} E_{0,k}^2(A_*) \rightarrow H_k(A_*) \rightarrow E_{k,0}^2(A_*) \rightarrow 0.$$

Instead of drawing the general case, as in 4.9.3, we picture the case $k = 3$, for $n \leq 4$:

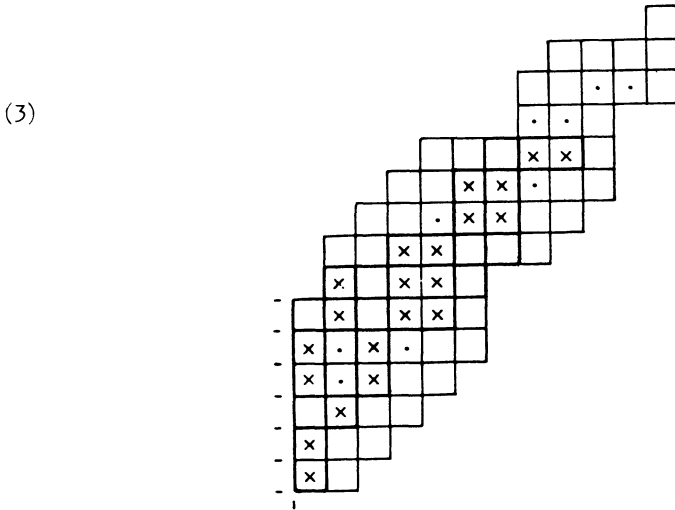

4.11. The theory of the cochain complex, with canonically bounded decreasing filtration, has an analogous canonical model in the discrete plane :

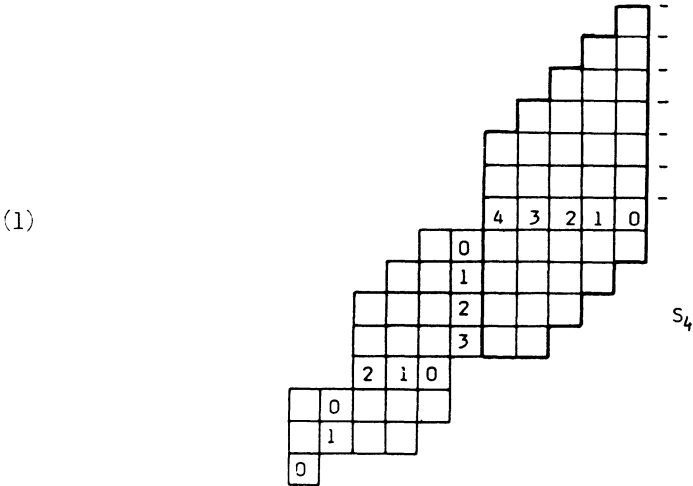

4.12. Last we notice that, by II.6.10, in order to prove a RE-statement (II.2.5) concerning the spectral sequence of a filtered complex (more generally, concerning the theory), it is sufficient to prove that it holds true in a fixed category of modules, for example abelian groups or real vector spaces.

5. THE REAL FILTERED CHAIN COMPLEX.

We give here the canonical model for the real filtered chain complex, and introduce the partial homologies E_{pqrs}^n, D_{pqrs}^n of Deheuvls [3]. The model can be used to prove various exact sequences concerning them ; instead their limits cannot be treated within the present scheme and are deferred to future works.

Here n is an integer variable, while $p, q, r, s, t, p', q', r', s'$ are real variables.

5.1. Consider the RE-theory $T = T_{\Delta}$ defined by the RE-graph Δ having object-set \mathbf{N} and morphisms

$$(1) \quad \partial_n : n \rightarrow n-1 \quad (n > 0),$$

$$(2) \quad f_p^n : n \rightarrow n \quad (n > 0, 0 \leq p \leq 1)$$

with RE-conditions :

$$(3) \quad \partial_n \in \text{Prp } \Delta, \quad \partial_n \partial_{n+1} \in \text{Nul } \Delta \quad (n > 0)$$

$$(4) \quad f_p^n \leq f_{p'}^n, \quad (p \leq p'),$$

$$(5) \quad f_0^n \in \text{Nul } \Delta, \quad f_1^n = 1,$$

$$(6) \quad \partial_n f_p^n \leq f_p^{n-1} \partial_n \quad (n > 0).$$

A model $A_* = ((A_n), (\partial_n), (f_p^n)) : \Delta \rightarrow \underline{A}$ is thus a chain complex provided with a real filtration.

5.2. Let \mathbf{R}' be the real line provided with the semitopology whose non-trivial closed sets are the following intervals of \mathbf{R} (and only them)

$$(1) \quad]\leftarrow, p] \quad \text{for } p \in \bigcup_{k \in \mathbf{Z}} [2k, 2k+1]$$

and consider the following points or subspaces or $\mathbf{R}' \times \mathbf{R}'$ (endowed with the product semitopology) :

$$(2) \quad \alpha_n = (-n, -n-1) \cdot + t^n(0, 1),$$

$$(3) \quad S_0^n = \{ (p, q) \in \mathbf{R}' \times \mathbf{R}' \mid 0 < p \leq 1, p-2 \leq q \leq 0 \},$$

$$(4) \quad S_n^n = \{ (p, q) \in \mathbf{R}' \times \mathbf{R}' \mid 0 < p \leq 1, p-2 \leq q \leq p \}, \quad n > 0,$$

(5)
$$S_n = \alpha_n + \iota^n(S_n^0),$$

(6)
$$F_p^n = \alpha_n + \iota^n(S_n^0 \cap ([0, p] \times \mathbf{R}^1)),$$

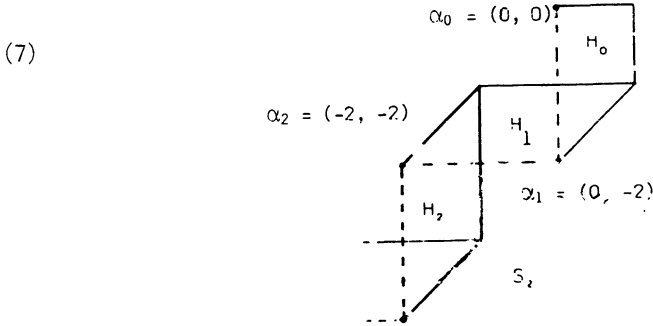

5.3. Theorem. Let $\Sigma = \{S_n \mid n \geq 0\}$. The theory T is idempotent and its canonical model is the following real diagram (in $\mathbf{R}^1 \times \mathbf{R}^1$):

(1)
$$S_* = ((S_n), (\partial_n), (f_p^n)) : \Delta \rightarrow L_0[\Sigma] ,$$

(2)
$$\partial_n = (S_n, S_n \cap S_{n-1} ; S_n \cap S_{n-1}) : S_n \rightarrow S_{n-1} ,$$

(3)
$$f_p^n = (F_p^n, F_p^n ; F_p^n) : S_n \rightarrow S_n .$$

Proof. Analogous to 4.4.

5.4. Consider the following locally closed subspaces of S_n (hence objects of $J_0 \langle \Sigma \rangle$), for $n \in \mathbf{N}$ and $1 \geq p \geq q \geq r \geq s \geq 0$:

(1)
$$E_{pqrs}^n = \alpha_n + \iota^n([r, q] \times]p-2, s]) \tag{6}$$

together with the proper normal morphisms (see the diagram (3)):

(2)
$$u : E_{pqrs}^n \longrightarrow E_{p'q'r's'}^n \quad (p \leq p' ; q \leq q' ; r \leq r' ; s \leq s')$$

(3) and (4) Cf. on the following page.

It is easy to see in (4) that there is an exact sequence of $J_0 \langle \Sigma \rangle$:

(5)
$$0 \rightarrow E_{ptrs}^n \xrightarrow{u} E_{pqrs}^n \xrightarrow{u} E_{pqt's}^n \rightarrow 0 \quad (r \leq t \leq q).$$

Analogously one can introduce the terms

(6)
$$D_{pqrs}^n = \alpha_n + \iota^n([s, r] \times]q-2, p-2])$$

and the normal morphisms (induced by the identity or by the differential ∂) among the terms E_{pqrs}^n, D_{pqrs}^n , finding again the exact sequences of Deheuvels ([3], § 17.1).

⁶⁾ $E_{pqrs}^n = \emptyset$ for $q = r$.

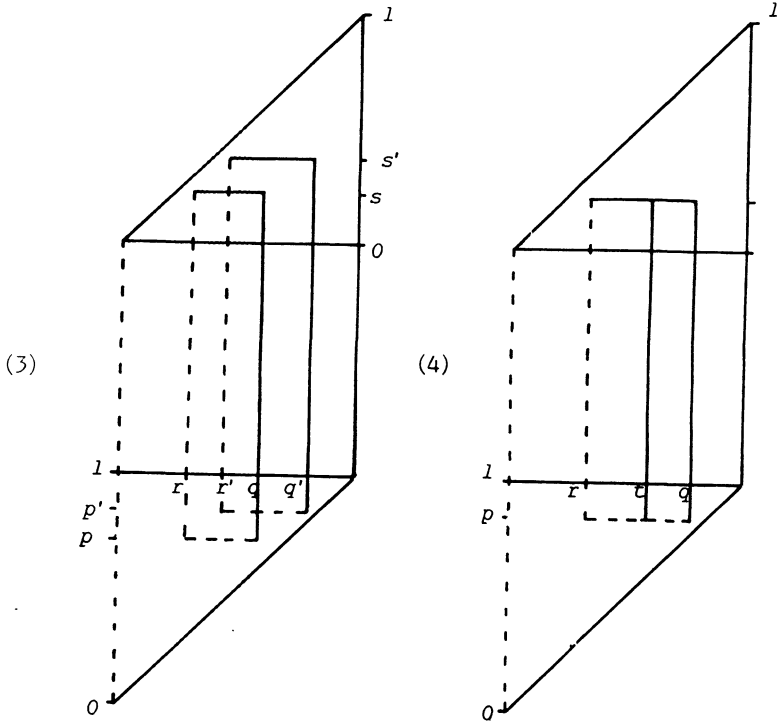

5.5. For every exact category \underline{E} and every real filtered complex on \underline{E} , $A_* : \Delta \rightarrow \text{Rel}(\underline{E})$, the global representation functor (1.4) :

(1)
$$\text{Rpr} : J_0 \langle \Sigma \rangle \times T^e(\underline{E}) \rightarrow \underline{E}$$

yields the partial homologies

(2)
$$E_{p'qrs}^n(A_*) = \text{Rpr}(E_{p'qrs}^n, A_*),$$

(3)
$$D_{p'qrs}^n(A_*) = \text{Rpr}(D_{p'qrs}^n, A_*)$$

together with their canonical morphisms and exact sequences.

6. THE DOUBLE COMPLEX.

We study here the RE-theory of the double chain complex

$$A_* = ((A_{pq}), (\partial'_{pq}), (\partial''_{pq}))$$

and introduce its two spectral sequences via the formulas ([5], p. 280):

$${}^r E_{pq}^r(A_*) = \left(\frac{(\partial^{r-1} \partial'')^{r-1} A \wedge \partial^{r-1} 0}{(\partial' \partial^{r-1})^{r-1} 0 \vee \partial' A} \right)_{pq}, \quad {}'' E_{pq}^r(A_*) = \left(\frac{(\partial^{r-1} \partial')^{r-1} A \wedge \partial^{r-1} 0}{(\partial'' \partial^{r-1})^{r-1} 0 \vee \partial' A} \right)_{pq}$$

which, in the abelian case, yield the usual terms derived from the contracted complex associated to A_* .

Our theory is idempotent, Hom-finite and has a canonical model in the discrete plane. Notice we assume $\partial'' \partial' = \partial' \partial''$ is null (6.1.6), otherwise one could give a model in L but probably not "glue" it in the discrete plane (6.9); indeed every double chain complex has various associated complexes satisfying this condition (e.g., $\text{Ker}(\partial'' \partial')$, $\text{Cok}(\partial' \partial'')$, $H(\partial'' \partial')$) and having isomorphic ${}^r E_{pq}^r$, ${}'' E_{pq}^r$ (for $r \geq 1$).

6.1. Let us consider the theory $T = T_\Delta$ defined by the RE-graph Δ with objects in $\mathbf{N} \times \mathbf{N}$ and morphisms :

- (1) $\partial'_{pq} : (p, q) \mapsto (p-1, q), \quad p > 0,$
- (2) $\partial''_{pq} : (p, q) \mapsto (p, q-1), \quad q > 0,$

subject to the following RE-conditions :

- (3) $\partial'_{pq} \in \text{Prp } \Delta ; \quad \partial''_{pq} \in \text{Prp } \Delta ,$
- (4) $\partial'_{p-1, q} \partial'_{pq} \in \text{Nul } \Delta ; \quad \partial''_{p, q-1} \partial''_{pq} \in \text{Nul } \Delta ,$
- (5) $\partial''_{p-1, q} \partial'_{pq} = \partial'_{p, q-1} \partial''_{pq} ,$
- (6) $\partial''_{p-1, q} \partial''_{pq} \in \text{Nul } \Delta .$

6.2. Let

$$(1) \quad A_* = ((A_{pq}), (\partial'_{pq}), (\partial''_{pq})) : \Delta \rightarrow \underline{A}$$

be a model of T , i.e. a double complex of \underline{A} . Each term A_{pq} is provided with a bifiltration

- (2) $\omega \leq \partial' \tilde{\partial}' \omega \leq (\partial' \tilde{\partial}'')^2 \omega \leq \dots \leq (\partial' \tilde{\partial}''')^q \omega \leq (\partial' \tilde{\partial}''')^q \partial' 1 \leq \dots$
 $\dots \leq \partial' \partial' \partial' 1 \leq \partial' 1 \leq \tilde{\partial}' \omega \leq \tilde{\partial}' \partial' \tilde{\partial}' \omega \leq \dots \leq (\tilde{\partial}' \partial'')^{p-1} \tilde{\partial}' \omega \leq$
 $\leq (\tilde{\partial}' \partial'')^p 1 \leq \dots \leq \tilde{\partial}' \partial' 1 \leq 1$
- (3) $\omega \leq \partial' \tilde{\partial}' \omega \leq \dots \quad \dots \leq \tilde{\partial}' \partial' 1 \leq 1$

where for example $(\partial' \partial'')^2 \omega$ is $\partial' \tilde{\partial}' \partial' \tilde{\partial}''(\omega)$, or more precisely :

$$(\partial'_{p+1, q} \tilde{\partial}''_{p+1, q} \partial'_{p+2, q-1} \tilde{\partial}''_{p+2, q-1})_R (\omega).$$

Moreover, by 6.1.6 :

(4) $\partial'1 \leq \tilde{\partial}''\omega$; $\partial''1 \leq \tilde{\partial}'\omega$.

6.3. Consider the following subspaces S_{pq} of $Z \times Z$ (with the product semitopology), where $\alpha_0 = \alpha_{00} = (0, 0)$ and $\iota : Z \times Z \rightarrow Z \times Z$ is the interchange of coordinates :

(1) $\alpha_n = (-\frac{n(n+1)}{2}, -\frac{n(n+1)}{2}) = \alpha_{n-1} - (n, n)$, $(n \geq 1)$

(2) $\alpha_{pq} = \alpha_{p+q} - \iota^{p+q}(p, q)$ $(p, q \geq 0)$,

(3) $S_{pq}^0 = ([-2q - 1, 0] \times [-2p - 1, 0]) \cup ([0, 2p] \times [0, 2q])$,

(4) $S_{pq} = \alpha_{pq} + \iota^{p+q}(S_{pq}^0)$.

The following diagram shows the union of the subspaces S

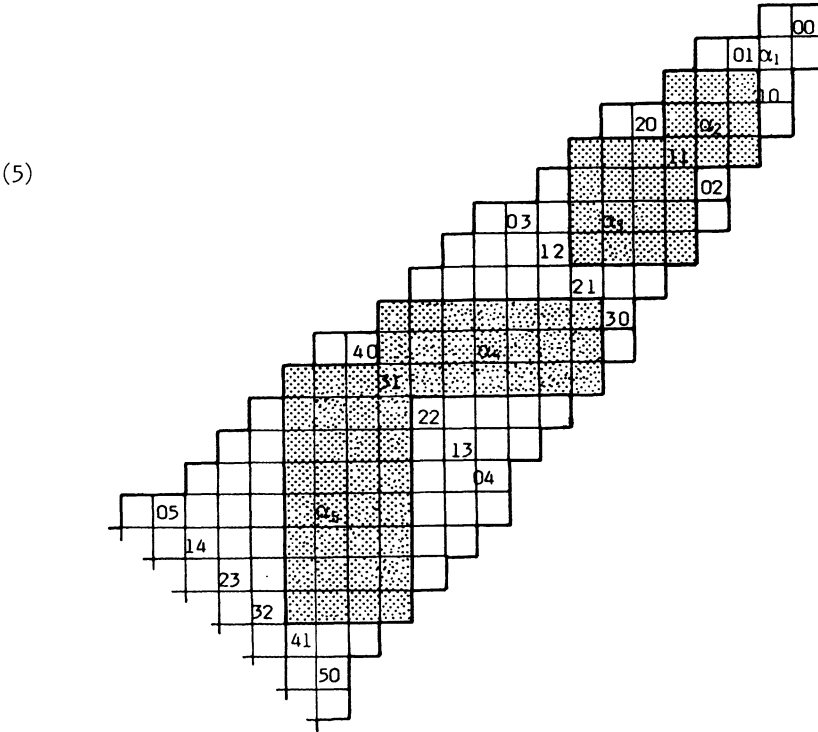

the dotted regions are $S_{1,1}$ and $S_{3,1}$; the point α_{pq} is denoted as " $p q$ ".
Consider also the T-model

$S_* = ((S_{pq}), (\partial'_{pq}), (\partial''_{pq})) : \Delta \rightarrow A_0 = L_0[\Sigma], \text{ with } \Sigma = \{ S_{pq} \mid p, q \geq 0 \} :$

$$(6) \quad \partial'_{pq} = (S_{pq}, S_{pq} \cap S_{p-1,q}; S_{pq} \cap S_{p-1,q}) : S_{pq} \rightarrow S_{p-1,q},$$

$$(7) \quad \partial''_{pq} = (S_{pq}, S_{pq} \cap S_{p,q-1}; S_{pq} \cap S_{p,q-1}) : S_{pq} \rightarrow S_{p,q-1}.$$

6.4. It will be useful to introduce the following notations and remarks, easy to guess from the diagram 6.3.5 (or also to prove by computation). Let :

$$(1) \quad \sigma : \mathbf{Z} \times \mathbf{Z} \rightarrow \mathbf{Z}, \quad \sigma(x, y) = x + y,$$

$$(2) \quad S = \cup S_{pq} ; \quad S_n = \cup_{p+q=n} S_{pq}.$$

Then, if $p+q=n$, take :

$$(3) \quad \sigma_n = \sigma(\alpha_{pq}) = \sigma(\alpha_n) - \sigma(p, q) = -n(n+1) - n = 1 - (n+1)^2,$$

$$(4) \quad S'_n = \{ (x, y) \in S \mid \sigma_n \leq \sigma(x, y) < \sigma_{n-1} \},$$

$$(5) \quad S''_n = \{ (x, y) \in S \mid \sigma_{n+1} < \sigma(x, y) \leq \sigma_n \},$$

$$(6) \quad S_n = S'_n \cup S''_n = \{ (x, y) \in S \mid \sigma_{n+1} < \sigma(x, y) < \sigma_{n-1} \}$$

so that S_{pq} decompose as the union of two rectangles, S'_{pq} and S''_{pq} :

$$(7) \quad S'_{pq} = S_{pq} \cap S'_n = \alpha_n + v^n([-p, p] \times [-q, q]),$$

$$(8) \quad S''_{pq} = S_{pq} \cap S''_n = \alpha_{n+1} + v^n([-q, q+1] \times [-p, p+1]),$$

$$(9) \quad S'_{pq} \cap S''_{pq} = \{ \alpha_{pq} \}.$$

6.5. Theorem. The discrete diagram S_* is a canonical model for the theory T (double chain complex). The theory is Hom-finite and idempotent.

Proof. We apply Criterion II (II.5.4) with

$$t_0 = S_*, \quad \Delta' = \emptyset, \quad \Delta' = \Delta, \quad I = J = -\mathbf{N}.$$

The conditions (C. 1, 2', 3, 4) are trivially satisfied. In order to verify (C.5) we remark that, by 6.4.6 :

$$(1) \quad S_n \cap S_{n'} \neq \emptyset \quad \text{iff} \quad |n - n'| \leq 1.$$

Consider now a non-null morphism $a \in \underline{A}_0(S_{pq}, S_{p'q'})$ with $p+q=n$, $p'+q'=n'$ and consequently $|n - n'| \leq 1$; recall (0.8) that $\text{Im}(a)$ is a locally closed subspace of S_{pq} and $S_{p'q'}$.

Case 1. Suppose that $n' = n-1$. Then :

$$(2) \quad S_{pq} \cap S_{p'q'} = (S_{pq} \cap S'_n) \cap (S_{p'q'} \cap S''_{n'}) =$$

$$\begin{aligned}
 &= (\alpha_n + \iota^n([-p, p] \times [-q, q])) \cap (\alpha_{n'+1} + \iota^{n'}([-q', q'+1] \times [-p', p'+1])) = \\
 &= \alpha_n + \iota^n (([-p, p] \times [-q, q]) \cap ([-p', p'+1] \times [-q', q'+1])).
 \end{aligned}$$

Let $r = p' - p = q - q' - 1$ and assume first that $r \geq 0$ (hence $p \leq p'$ and $q' < q$); consider then the morphism :

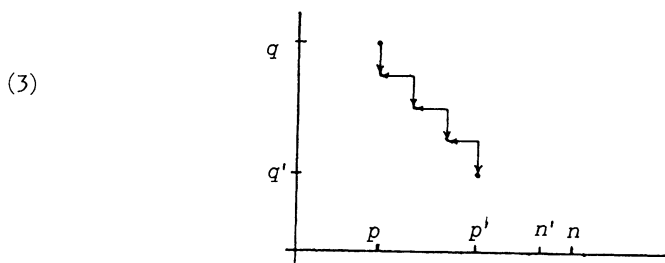

(4)
$$b = \partial_{p', q'+1}'' \dots \tilde{\partial}_{p'+1, q-1}' \partial_{pq}'' \in \underline{A}_0(S_{pq}, S_{p'q'})$$

whose image is :

(5)
$$\begin{aligned}
 \text{Im}(b) &= \bigcap_{s=0}^r (S_{p+s, q-s} \cap S_{p+s, q-s-1}) = \bigcap_{s=0}^r (S_{p+s, q-s} \cap S_{p+s, q-s-1}^{\prime\prime}) = \\
 &= \alpha_n + \iota^n (\bigcap_{s=0}^r ([-p-s, p+s] \times [-q+s, q-s]) \cap ([-p-s, p+s+1] \times [-q+s+1, q-s])) = \\
 &= \alpha_n + \iota^r ([-p, p] \times [-q+r+1, q-r]) = \alpha_n + \iota^n ([-p, p] \times [-q', q'+1]) = S_{pq} \cap S_{p'q'}.
 \end{aligned}$$

Thus $\text{Im}(a) \subset S_{pq} \cap S_{p'q'} = \text{Im}(b)$, and $a \ll b$ (0.9.3).

Analogously, if $r < 0$ ($p' < p$, $q' \geq q$), consider

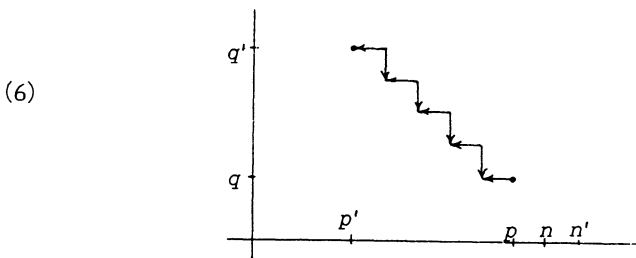

(7)
$$b = \partial_{p'+1, q'}' \dots \tilde{\partial}_{p-1, q+1}'' \partial_{pq}' \in \underline{A}_0(S_{pq}, S_{p'q'}).$$

Also here $\text{Im}(b) = S_{pq} \cap S_{p'q'}$ and $a \ll b$.

Case 2. If $n' = n+1$ we apply the preceding argument to

$$\tilde{a} \in \underline{A}_0(S_{p'q'}, S_{pq}).$$

Case 3. Last, if $n = n'$ (and $(p, q) \neq (p', q')$: II.5.3) we may assume that $p < p'$ and $q' < q$. $S_{pq} \cap S_{p'q'}$ is the union $R' \cup R''$ of the following rectangles :

$$(8) \quad R' = S_{pq} \cap S_{p'q'} \cap S_n'' = \alpha_n + \iota^n([\![-p, p]\!] \times [\![-q, q]\!]) \cap ([\![-p', p']\!] \times [\![-q', q']\!]) \\ = \alpha_n + \iota^n([\![-p, p]\!] \times [\![-q', q']\!]),$$

$$(9) \quad R'' = S_{pq} \cap S_{p'q'} \cap S_n'' = \alpha_{n+1} + \iota^{n+1}([\![-q', q' + 1]\!] \times [\![-p, p + 1]\!]).$$

Since $L = \text{Im}(a)$ is locally closed in both S_{pq} and $S_{p'q'}$, it must be contained in one of these rectangles R', R'' . Otherwise L should contain a point α' in S_{pq} and a point α'' in $S_{p'q'}$; since $\alpha'' \leq \alpha_{pq} \leq \alpha'$ and L is locally closed in S_{pq} , L should also contain α_{pq} , which does not belong to $S_{p'q'}$.

Thus a is dominated by one of the following morphisms :

$$(10) \quad b' = \tilde{\partial}'_{p',q'} \dots \tilde{\partial}'_{p+1,q-1} \partial'_{pq} ,$$

$$(11) \quad b'' = \partial''_{p',q'+1} \dots \partial''_{p+1,q} \tilde{\partial}'_{p+1,q}$$

whose images are respectively R' and R'' (the proof is analogous to (5)).

Our last step is to verify (C.6) via II.4.6. For each $p, q \geq 0$, $X_{pq} = \text{Rst}(S_{pq})$ is (1.12) the free modular 0, 1-lattice generated by its ordered subset $X_{p,q}^0$ containing the restrictions ($i = ', ''$) :

$$(12) \quad i_{F_i}{}^{pq} = (i_{F_i}{}^{pq}, i_{F_i}{}^{pq} ; i_{F_i}{}^{pq}) : S_{pq} \rightarrow S_{pq} ,$$

$$(13) \quad 'F_i{}^{pq} = \alpha_{pq} + \iota^{p+q}(S_{pq} \cap ([\![\leftarrow, r]\!] \times \mathbf{Z})), \quad -2q-1 \leq r < 2p ,$$

$$(14) \quad ''F_i{}^{pq} = \alpha_{pq} + \iota^{p+q}(S_{pq} \cap (\mathbf{Z} \times [\![\leftarrow, r]\!])), \quad 2p-1 \leq r < 2q .$$

Therefore II.4.6 a holds, as well as II.4.6 b :

$$(15) \quad 'f_{-2q-2+s}{}^{pq} = (\partial' \tilde{\partial}'')^s(\omega) = \\ = (\partial_{p+1,q} \dots \partial_{p+s,q-s+1} \tilde{\partial}'_{p+s,q-s+1}) (\omega), \quad 0 < s \leq q ,$$

$$(16) \quad 'f_{-s-1}{}^{pq} = (\partial' \tilde{\partial}'')^s \partial'(1), \quad 0 \leq s \leq q ,$$

$$(17) \quad 'f_s{}^{pq} = (\tilde{\partial}' \partial'')^s \partial'(\omega), \quad 0 \leq s < p ,$$

$$(18) \quad 'f_{2p-s}{}^{pq} = (\tilde{\partial}' \partial'')^s (1), \quad 0 < s \leq p ,$$

and analogously for $''f_i{}^{pq}$

Now the order relation on X_{pq}^0 is generated by :

$$(19) \quad 'f_i{}^{pq} \leq 'f_{i+1}{}^{pq} , \quad ''f_i{}^{pq} \leq ''f_{i+1}{}^{pq} ,$$

$$(20) \quad 'f_{-1}{}^{pq} \leq ''f_0{}^{pq} , \quad ''f_{-1}{}^{pq} \leq 'f_0{}^{pq} .$$

Therefore, by 6.2.2, 3, 4, for every model $A_* : \Delta \rightarrow \underline{A}$ and each

$(p, q) \in \mathbf{N} \times \mathbf{N}$, the condition II.4.6 c is satisfied, and there is exactly one homomorphism of 0, 1-lattices $\vartheta_{pq} : X_{pq} \rightarrow \text{Rst}(A_{pq})$ transforming the bifiltration $(f_{pq}^I), (f_{pq}^E)$ into the bifiltration 6.2.2-3 of A_{pq} .

Finally we have to verify II.4.6 d, and the checking can be obviously restricted to morphisms ϑ_{pq}^1 of Δ . On account of the four "formulas" (15)-(18) for the terms f_{pq}^I , of the four analogous one for the terms f_{pq}^E and of the two kinds of variance (direct or inverse images) we have sixteen cases to consider; we only write down one of them ($0 \leq s < p$; the context suggests which differentials belong to S_* and which to A_*):

$$(21) \quad (\vartheta_{pq}^1)_R (\vartheta_{pq}^1 f_{pq}^E) = \partial' \tilde{\partial}' (\partial'' \tilde{\partial}' f_{pq}^E) (\omega) = ((\partial'' \tilde{\partial}')^S (\omega) \wedge \text{val } \partial') = \\ = \vartheta_{p-1, q} ((\partial'' \tilde{\partial}')^S (\omega) \wedge \partial'(1)) = \vartheta_{p-1, q} (\partial' \tilde{\partial}' (\partial'' \tilde{\partial}')^S (\omega)) = \vartheta_{p-1, q} (\partial_R^1 (f_{pq}^E)).$$

6.6. We are interested in the following objects of $J_0 \langle \Sigma \rangle$ (locally closed subspaces of S_{pq}):

- (1) $E_{pq}^0 = E_{pq}^1 = S_{pq}$,
- (2) $E_{pq}^I = \alpha_{pq} + \nu^{p+q}([\min(-2q-2+r, -q), \max(2p+1-r, p)] \times \{0\})$, $r \geq 1$,
- (3) $E_{pq}^\infty = E_{pq}^I = \alpha_{pq} + \nu^{p+q}([-q, p] \times \{0\})$, for $r > \max(p, q+1)$,
- (4) $E_{pq}^E = \alpha_{pq} + \nu^{p+q}(\{0\} \times [\min(-2p-2+r, -p), \max(2q+1-r, q)] \times \{0\})$, $r \geq 1$,
- (5) $E_{pq}^\infty = E_{pq}^E = \alpha_{pq} + \nu^{p+q}(\{0\} \times [-p, q])$, for $r > \max(p+1, q)$

which are here exemplified for $p=3, q=1$:

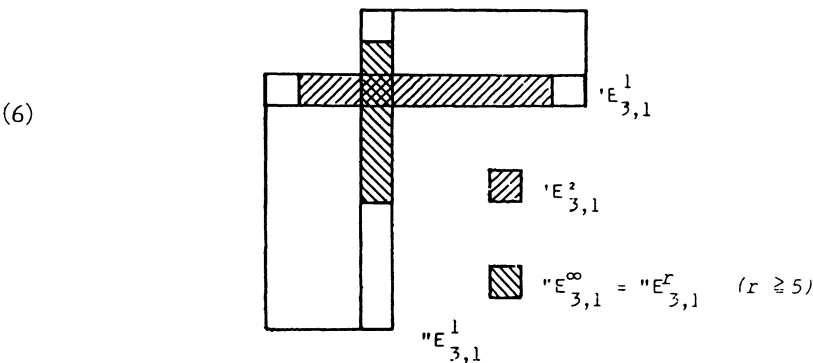

Moreover, in the exact category $J_0 \langle \Sigma \rangle$:

$$(7) \quad E_{pq}^I = \left(\frac{(\tilde{\partial}' \partial'')^{r-1} (1) \wedge \tilde{\partial}' (\omega)}{(\partial' \tilde{\partial}'')^{r-1} (\omega) \vee \partial' (1)} \right)_{pq} \quad (r \geq 1)$$

analogously for ${}''E_{pq}^r$.

It is easy to see, in 6.3.5, that there are proper normal morphisms (§ 9) :

$$(8) \quad \partial_{pq}^r : {}'E_{pq}^r \rightarrow {}'E_{p-r, q+r-1}^r,$$

$$(9) \quad {}''\partial_{pq}^r : {}''E_{pq}^r \rightarrow {}''E_{p+r-1, q-r}^r$$

which produce order-two sequences

$$(10) \quad {}'E_{p+r, q-r+1}^r \rightarrow {}'E_{pq}^r \rightarrow {}'E_{p-r, q+r-1}^r,$$

$$(11) \quad {}''E_{p-r+1, q+r}^r \rightarrow {}''E_{pq}^r \rightarrow {}''E_{p+r-1, q-r}^r$$

whose homology is respectively ${}'E_{pq}^{r+1}$, ${}''E_{pq}^{r+1}$.

6.7. Thus, for every double complex $A_* : \Delta \rightarrow \text{Rel}(\underline{E})$ in the exact category \underline{E} , we have two spectral sequences (1.4) :

$$(1) \quad {}'E_{pq}^r(A_*) = \text{Rpr}({}'E_{pq}^r, A_*),$$

$$(2) \quad {}''E_{pq}^r(A_*) = \text{Rpr}({}''E_{pq}^r, A_*)$$

with differentials and homologies as in 6.6.8-11.

6.8. Last we notice that the more general theory $T' = T'_\Delta$ obtained by dropping the annihilation condition 6.1.6 (i.e., the "usual" double chain complex) has a canonical model

$$(1) \quad S'_* = ((S'_{pq}), (\partial'_{pq}), (\partial''_{pq})) : \Delta' \rightarrow L_o[\Sigma']$$

where S'_{pq} has the following form :

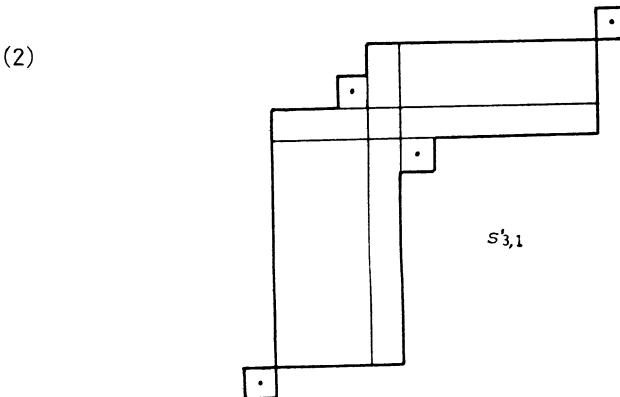

and contains four (dotted) squares which are not in S_{pq} (see 6.6.6).

The theory is idempotent, hence the model can be glued in L_0 (II.6.9). It seems not possible to realize the glueing in the (discrete plane).

7. OTHER EXAMPLES : NON-IDEMPOTENT THEORIES.

We give here some examples (7.3-8) of non-idempotent theories, among which the filtered differential object (7.6-7). Our last example shows the theory T of the Λ -filtered object, where Λ is a (partially) ordered set ; T is distributive iff the free modular lattice generated by Λ is such. On the contrary, we do not "know" the canonical model of T , while it is always easy to describe the canonical transfer model.

7.1. We already know that every idempotent RE-category is transfer (I.8.2). A more general condition implying that the RE-category \underline{A} is transfer is :

a) every endomorphism of \underline{A} is either idempotent or *nihilpotent* (i.e., it has a positive power which is a null morphism).

Indeed, let a, b be parallel morphisms of \underline{A} and $a_R = b_R, a^R = b^R$; in particular $\tilde{a}\tilde{a} = \tilde{b}\tilde{b}$, as :

$$\underline{n}(\tilde{a}\tilde{a}) = a^R(1) \quad \text{and} \quad \underline{d}(\tilde{a}\tilde{a}) = a^R(\omega)$$

by I.7.1 and I.4.10). Analogously, $a\tilde{a} = b\tilde{b}$.

Now, if the endomorphism $a\tilde{b}$ is idempotent, the Remark I.2.8.2 proves that $a = b$. Otherwise there is a positive integer k such that $(a\tilde{b})^k \in \text{Nul}(\underline{A})$; therefore :

$$(1) \quad a_R = ((a\tilde{a})^k a)_R = (a_R a^R)^k a_R = (a_R b^R)^k a_R = ((\tilde{a}\tilde{b})^k)_R a_R .$$

As the functor $\text{Rst} : \underline{A} \rightarrow \text{Mlr}$ preserves and reflects null morphisms, (1) proves that a is null and

$$b = (b\tilde{b})b(\tilde{b}\tilde{b}) = (a\tilde{a})b(\tilde{a}\tilde{a}) = a(\tilde{a}\tilde{b}\tilde{a})a = a .$$

7.2. Corollary. Let T be a distributive theory on Δ and suppose that each model $t : \Delta \rightarrow \underline{A}$ of T turns every endomorphism of $I(\Delta)$, the free involutive category generated by Δ , into an idempotent or a nihilpotent endomorphism of \underline{A} . Then T is transfer ; moreover, every model of T is such.

Proof. It follows immediately from 7.1 and II.5.2, applied to the RE-factorization of any model of T .

7.3. The automorphism. We consider here a very simple boolean non-

transfer theory, to show which kind of relations can exist between the canonical model and the c.t.m. outside the transfer case ; we also remark that the theory is finitely generated and infinite. Of course, this theory is so simple that the knowledge of the canonical model throws no special light on it.

Let $T = T_{\Delta}$ be the theory determined by the RE-graph Δ having one object 0 and one morphism $u : 0 \rightarrow 0$, with RE-conditions :

$$(1) \quad \tilde{u}u = u\tilde{u} = 1.$$

A model $A_{*} = (A, u) : \Delta \rightarrow \underline{A}$ is given by any automorphism $u : A \rightarrow A$ of \underline{A} . The canonical model is :

$$(2) \quad S_{*} = (Z, v) : \Delta \rightarrow \underline{A}_0 = L(v)$$

where Z is provided with the coarsest (semi)topology, $v : Z \rightarrow Z, k \mapsto k+1$ is an automorphism of L and $\underline{A}_0 = L(v)$ is the Prj-full subcategory of L spanned by v (1.1). \underline{A}_0 has the following morphisms :

$$(3) \quad v^r : Z \rightarrow Z, \quad k \mapsto k+r \quad (r \in Z),$$

$$(4) \quad \omega, \Omega, 0, \tilde{0} : Z \rightarrow Z.$$

The proof is direct and obvious : for each T -model $A_{*} = (A, u) : \Delta \rightarrow \underline{A}$ the RE-functor $F : \underline{A}_0 \rightarrow \underline{A}$:

$$(5) \quad F(Z) = A, \quad F(v^r) = u^r, \quad F(\omega) = \omega_A, \quad F(\Omega) = \Omega_A, \quad F(0) = 0_{A,A}, \quad F(\tilde{0}) = \tilde{0}_{A,A}$$

is clearly the only one verifying $A_{*} = FS_{*}$.

As $\text{Rst}_{\underline{A}_0}(Z) = \{\omega, 1\}$ and $(v^r)_R = 1_R$ for each $r \in Z$, the theory is boolean and not transfer. The c.t.m., by II.4.2, is :

$$(6) \quad S'_{*} = \text{Rst}_{\underline{A}_0}.S_{*} : \Delta \rightarrow \text{Mlr}$$

$$(7) \quad S'_{*}(0) = \{\omega, 1\}; \quad S'_{*}(u) = 1$$

which clearly does not yield back the canonical model via RE-factorization (as it happens for transfer theories, and only for them : II.4.5).

7.4. The differential object. This example shows a simple finite transfer, distributive, non-idempotent theory.

The theory is $T = T_{\Delta}$ where the RE-graph Δ has one object 0, one endomorphism $\partial : 0 \rightarrow 0$ and RE-conditions :

$$(1) \quad \partial \in \text{Prp } \Delta; \quad \partial\partial \in \text{Nul } \Delta.$$

The canonical model is :

$$(2) \quad S_{*} = (S, \partial) : \Delta \rightarrow L(\partial)$$

where $S = \{0, 1, 2\}$ with the natural-order topology (closed sets : $\emptyset, \{0\}, \{0, 1\}, S$) and $\partial \in J(S, S)$ is the open-closed partial homeomorphism turning 2 into 0. $L(\partial)$ is the Prj-full involutive subcategory of L spanned by ∂ ; the proof, also here, is direct and easy. By 7.2 the theory is transfer, and even every model is so.

7.5. The endomorphism. This theory generalizes the two above ; it is transfer, distributive, non-idempotent and *it has also non-transfer models*; it is finitely generated and infinite.

The theory is $T = T_{\Delta}$ where Δ is the graph

(1) $a : 0 \rightarrow 0$

with no RE-conditions. Every model $A_{*} = (A, a) : \Delta \rightarrow A$ produces a bi-filtration of A :

(2) $\omega \leq \underline{ind}(a) \leq \underline{ind}(a^2) \leq \dots \leq \underline{val}(a^2) \leq \underline{val}(a) \leq 1,$

(3) $\omega \leq \underline{ann}(a) \leq \underline{ann}(a^2) \leq \dots \leq \underline{def}(a^2) \leq \underline{def}(a) \leq 1.$

Let I be the set of integers *with the following order* :

(4) $1 < 2 < 3 < \dots < -3 < -2 < -1 < 0$

and $I' = \{1, 2, 3, \dots\}, I'' = \{0, -1, -2, -3, \dots\}$. One can prove that the canonical model of T is

(5) $S_{*} = (S, b) : \Delta \rightarrow L(b)$

where $S = I \times I$, with the product semitopology, and $b \in L(S, S)$ has the following quaternary factorization (the intervals are relative to (4)!) :

(6) $S \longleftarrow I \times]1, 0[\xrightarrow{b_0} I \times]1, 0[\xrightarrow{b_0}]1, 0[\times I \longleftarrow]1, 0[\times I \xrightarrow{b_0} S.$

Here b_0 is the following homeomorphism (i' denotes the antecedent of $i > 1$ and i'' the subsequent of $i < 0$) :

(7) $b_0(i, j) = (i'', j')$ for $i \in I', j \in I' \cap]1, 0[,$

(8) $b_0(i, j) = (i'', j'')$ for $i \in I', j \in I'' \cap]1, 0[,$

(9) $b_0(i, j) = (i', j')$ for $i \in I'', j \in I' \cap]1, 0[,$

(10) $b_0(i, j) = (i', j'')$ for $i \in I'', j \in I'' \cap]1, 0[.$

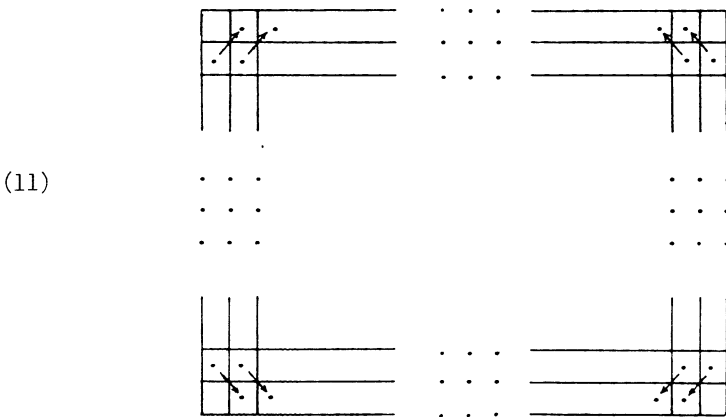

The theory is transfer and distributive ; every model $A_* = (A, a) : \Delta \rightarrow \underline{A}$ where $a : A \rightarrow A$ is a non-identical automorphism, is not transfer.

The theory is not idempotent ; we also notice that there seems to be no simple way (generalizing the Deletion Rule, 1.7) to derive from its canonical model the one of the more particular theory of the automorphism (7.3).

7.6. The n -filtered differential object. This theory is finite, distributive, transfer, non-idempotent. The canonical model is similar to the one of the filtered complex (§ 4).

Our theory is $T = T_\Delta$, where Δ is the RE-graph having one object 0 and morphisms

- (1) $\partial : 0 \rightarrow 0,$
- (2) $e_p : 0 \rightarrow 0, \quad p = 0, 1, \dots, n,$

with RE-conditions :

- (3) $\partial \in \text{Prp } \Delta, \quad \partial \partial \in \text{Nul } \Delta,$
- (4) $e_p \leq e_{p+1} \leq e_n = 1 \quad (p < n),$
- (5) $\partial e_p \leq e_p \partial .$

The canonical model is :

- (6) $S_* = (S, \partial, (e_p)) : \Delta \rightarrow \underline{A}_0 = L(\partial)$
 where

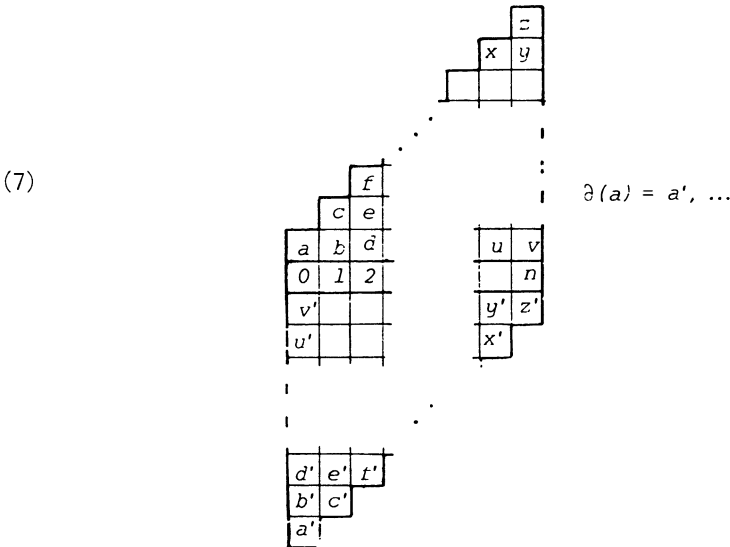

(8) $S = \{ (p, q) \in \mathbf{Z} \times \mathbf{Z} \mid 0 \leq p \leq n ; p-n-1 \leq q \leq p+1 \}$

is a subspace of $\mathbf{Z} \times \mathbf{Z}$ (product semitopology : 1.8),

(9) $\partial : S \rightarrow S, (p, q) \mapsto (q-1, p-n-1) \text{ for } q > 0$

is a proper morphism ($\partial \in J(S, S)$), i.e., a partial open-closed homeomorphism, and :

(10) $e_p = (H_p, H_p ; H_p) \in L_o(S, S),$

(11) $H_p = S \cap ([0, p] \times \mathbf{Z}).$

The proof can follow this outline. First prove that

$$S'_* = \text{Rst}_{\underline{A}_o} . S_* : \Delta \rightarrow \text{Mir}$$

is a c.t.m. for T, via II.4.6-7 (the proof is similar to the analogous one in 4.4). Thus T is distributive, and it is easy to check that it is also transfer (by 7.2). By II.4.5 we only need to verify that S'_* is a q-morphism which follows easily from Lemma II.5.2 ; the condition a is trivial, b follows from the fact that S'_* is Rst-spanning (II.4.4) and c from the definition of $L(\partial)$ (1.1).

7.7. The real-filtered differential object. Analogously this theory has the following canonical model in $\mathbf{R}' \times \mathbf{R}'$ (5.2) :

(1) $S_* = (S, \partial, (f_p)_{0 \leq p \leq 1}) : \Delta \rightarrow L(\partial),$

(2) $S = \{ (p, q) \in \mathbf{R}' \times \mathbf{R}' \mid 0 < p \leq 1, p \leq q \leq p+2 \}$

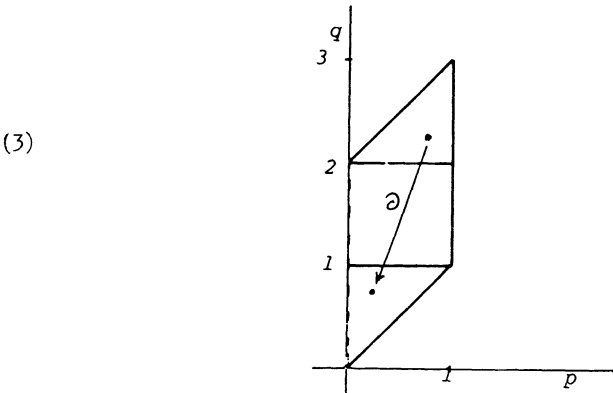

(4) $\partial \in J(S, S) ; \partial(p, q) = (q-2, p) \text{ for } q > 2,$

(5) $f_p = (F_p, F_p ; F_p) \in L_o[S],$

(6) $F_p = S \cap ([0, p] \times \mathbf{R}').$

7.8. The Λ -filtered object. Last we consider a theory which "generally"

is not even distributive ; the theory is $T = T_{\Delta}$, where Δ is the RE-graph having one object 0 and a family $(e_{\lambda})_{\lambda \in \Lambda}$ of endomorphisms indexed on a (partially) ordered set Λ , with RE-conditions :

$$(1) \quad e_{\lambda} \leq e_{\lambda'} \leq 1, \quad \text{for } \lambda \leq \lambda' \quad \text{in } \Lambda.$$

Say X the free modular 0, 1-lattice generated by Λ , which will be embedded in X . The RE-morphism

$$(2) \quad t_1 : \Delta \rightarrow Mlr,$$

$$(3) \quad t_1(0) = X,$$

$$(4) \quad t_1(e_{\lambda}) : X \rightarrow X ; (t_1 e_{\lambda})(x) = (t_1 e_{\lambda})^*(x) = x \wedge \lambda$$

is clearly the c.t.m. of T : for each model $t : \Delta \rightarrow Mlr$ there exists exactly one homomorphism of 0, 1-lattices $\vartheta_0 : X \rightarrow t(0)$ such that

$$\vartheta_0(\lambda) = (t e_{\lambda})(1) ;$$

in other words, exactly one horizontal transformation (II.4.7)

$$\vartheta : t_1 \rightarrow t : \Delta \rightarrow Mhr.$$

The theory is distributive iff X is so (II.4.3) ; in this case the theory is also idempotent by II.5.2. For example this happens when Λ is the union of two chains (§ 2).

If Λ is a set with trivial order and $\text{card } \Lambda > 2$, then the theory is not distributive ([1], p. 63); if $\text{card } \Lambda > 3$, X is also infinite and so is T ([1], p. 64). We do not know whether T is transfer or not, and which is its canonical model.

REFERENCES

1. G. BIRKHOFF, Lattice Theory, Coll. Publ. A.M.S., New York 1973.
2. H. CARTAN & S. EILENBERG, Homological Algebra, Princeton Univ. Press, 1956.
3. R. DEHEUVELS, Topologie d'une fonctionnelle, Ann. Math. **61** (1955), 13-72.
4. M. GRANDIS, Spazi con operatori e applicazioni al problema di Knaster, Rend. Sem. Mat. Univ. Padova **38** (1967), 258-286.
5. M. GRANDIS, Il sistema spettrale di un complesso multiplo, Rend. Sem. Mat. Univ. Padova **40** (1968), 252-298.
6. M. GRANDIS, Induction in orthodox involution categories (Orthodox Categories 3), Ann. mat. Pura Appl. **116** (1978), 87-99.
7. M. GRANDIS, Quaternary categories having orthodox symmetrizations (Orthodox Symmetrizations 1), Boll. Un. Mat. Ital. **14-B** (1977), 605-629.
8. M. GRANDIS, Distributive unions in semilattices and in inverse symmetrizations, Riv. Mat. Univ. Parma **6** (1980), 363-378.
9. M. GRANDIS, Zeeman diagrams for homological systems, Rapporti Scient. Ist. Mat. Univ. Genova **102** (1981).
10. M. GRANDIS, Concrete representations for inverse and distributive exact categories, Rend. Accad. Naz. Sci. XL Mem. Mat. **8** (1984), 99-120.
11. M. GRANDIS, The running knot Theorem for idempotent categories, Boll. UMI **4**,
12. M. GRANDIS, On distributive homological algebra, I. RE-categories, Cahiers Top. et Géom. Diff. **XXV-3** (1984), 259-302.
13. M. GRANDIS, Id, II. Theories and models, Id **XXV-4** (1984), 353-380.
14. P.J. HILTON & S. WYLIE, Homology Theory, Cambridge Univ. Press, 1962.
15. S. MAC LANE, Homology, Springer, 1963.
16. S. MAC LANE, Categories for the working mathematician, Springer, 1971.
17. B. MITCHELL, Theory of categories, Academic Press, 1965.
18. D. PUPPE, Korrespondenzen in abelschen Kategorien, Math. Ann. **148** (1962), 1-30.
19. E.H. SPANIER, Algebraic topology, Mc Graw-Hill, New York 1966.
20. E.C. ZEEMAN, On the filtered differential group, Ann. Math. **66** (1957), 557-585.

Istituto di Matematica
Via L.B. Alberti, 4
I-16132 GENOVA. ITALY.