

Astérisque

M. G. ZAIDENBERG

An analytic cancellation theorem and exotic algebraic structures on C^n , $n \geq 3$

Astérisque, tome 217 (1993), p. 251-282

http://www.numdam.org/item?id=AST_1993__217__251_0

© Société mathématique de France, 1993, tous droits réservés.

L'accès aux archives de la collection « Astérisque » (<http://smf4.emath.fr/Publications/Asterisque/>) implique l'accord avec les conditions générales d'utilisation (<http://www.numdam.org/conditions>). Toute utilisation commerciale ou impression systématique est constitutive d'une infraction pénale. Toute copie ou impression de ce fichier doit contenir la présente mention de copyright.

NUMDAM

Article numérisé dans le cadre du programme
Numérisation de documents anciens mathématiques

<http://www.numdam.org/>

An analytic cancellation theorem and exotic algebraic structures on C^n , $n \geq 3$

M. G. Zaidenberg

Introduction

Zariski's problem on cancellation (by an affine space) is usually formulated as follows * :

Let $X \times A^n \simeq Y \times A^n$ be an isomorphism of algebraic varieties. Does it follow that $X \simeq Y$?

In general, the answer is negative even for surfaces over C [Da] , [tDi] . In an important special case, when $Y = A^k$, it is known only that the answer is positive for $k \leq 2$ (M. Miyanishi - T. Sugie and T. Fujita, see [Fu 2] or [Km]).

It was C. P. Ramanujam, who in his earlier attempt to prove the latter result noticed a connection of the problem with the question of existence of exotic algebraic structures on affine spaces [Ra] . The main theorem in [Ra] on a characterization of the affine plane implies that the only complex algebraic structure on R^4 is the standard structure of C^2 . (The proof of this theorem contains a great deal of tools that are used now in a study of acyclic algebraic surfaces.) Producing the first example of a topologically contractible smooth complex algebraic surface X , non-isomorphic to C^2 , C. P. Ramanujam remarked that by the h-cobordism theorem the threefold $X \times C$ is diffeomorphic to C^3 , but it is not isomorphic as algebraic variety to C^3 provided that the above version of the cancellation problem is answered affirmatively. Thus, this does lead to an exotic complex algebraic structure on R^6 .

In 1987–1989 many new examples of acyclic and contractible algebraic surfaces were constructed (see for instance, [Gu Mi], [tDi Pe], [Su], [Za 2]). In the **Appendix** to this paper we shall describe two countable series of examples in which each surface X carries a family of curves $X \rightarrow C$ with a generic fibre $C^{**} := C \setminus \{0, 1\}$. We shall distinguish these surfaces up to isomorphism and calculate their logarithmic Kodaira dimensions $\bar{k}(X)$. For most of them $\bar{k}(X) = 2$, so they are of hyperbolic (or log-general) type. In [Za 1], [Za 3] it is proved that

* for the original setting see, for instance, [Ab Ha Ea]

they are the only examples of acyclic surfaces of log-general type which support isotrivial families of curves with the base \mathbb{C} (i.e. families with pairwise isomorphic generic fibres). Following [Ra] we use these surfaces in order to introduce exotic algebraic structures on affine spaces.

Main Theorem. *For any $n \geq 3$ there exists a countable set of complex affine algebraic structures on \mathbb{R}^{2n} which are pairwise biholomorphically nonequivalent.*

These structures can be distinguished in an algebraic sense, using the Strong Cancellation Theorem of Iitaka and Fujita [Ii Fu]. And by Strong Analytic Cancellation Theorem 1.10 they differ even in the analytic sense. Indeed, by the Iitaka-Fujita Theorem given an isomorphism $X \times \mathbb{C}^n \rightarrow Y \times \mathbb{C}^n$ the \mathbb{C}^n can be cancelled if $\bar{k}(Y) \geq 0$. By Theorem 1.10 below, given a biholomorphism $X \times \mathbb{C}^n \rightarrow Y \times \mathbb{C}^n$, where X and Y are quasiprojective, the \mathbb{C}^n can be cancelled, giving an isomorphism $X \rightarrow Y$ if $\bar{k}(Y) = \dim_{\mathbb{C}} Y$, i.e. if Y is of hyperbolic type. The examples of non-cancellation for (\mathbb{Q} -acyclic) smooth affine surfaces with $\bar{k} = -\infty$ [Da], [tDi] show that the assumptions of the first theorem are necessary, while for the second one this is unknown. I do not know also, whether there exist two different complex algebraic structures on \mathbb{R}^{2n} which are analytically the same.

Furthermore, we show that for an acyclic surface X of hyperbolic type, \mathbb{C}^n cannot be isomorphic to (and even cannot injectively dominate) a hypersurface of $X \times \mathbb{C}^{n-1}$ (Theorem 2.4). (In particular, 'exotic \mathbb{C}^n ' constructed in such a way do not contain \mathbb{C}^{n-1} .) This is a generalization of a theorem in [Za 3] on the absence of simply connected curves in acyclic surfaces of general type.

A report on this paper was done at the 29-th Arbeitstagung in Bonn, 1990. It was prepared during the author's stay at the Max Planck Institut für Mathematik at Bonn and as a guest of the SFB-170 'Algebra and Geometry' at the Mathematisches Institut of Gottingen University. I am very thankful to these Institutes for their hospitality.

Remark. Recently A. Dimca, Sh. Kaliman and P. Russell have obtained new examples of exotic $\mathbb{C}^3 - s$, which are hypersurfaces in \mathbb{C}^4 . For some of them $\bar{k} = 2$.

1. An analytic cancellation theorem

Let us first recall some known facts about holomorphic mappings into manifolds of hyperbolic type.

1.1. Definition [Ii 1]. A nonsingular quasiprojective variety X is called a manifold of hyperbolic type iff its logarithmic Kodaira dimension $\bar{k}(X)$ coincides with the dimension $\dim_{\mathbb{C}} X$.

1.2. Theorem. Let X be a nonsingular quasiprojective variety and Y be a manifold of hyperbolic type. Then

- a) [Sa, Theorem 4.1] Y is a volume hyperbolic complex manifold;
- b) [Sa, Proposition 4.2] Every dominant holomorphic mapping $X \rightarrow Y$ is regular;
- c) [Ii 1, p. 182, Corollary] Every dominant holomorphic mapping $Y \rightarrow Y$ is a biregular automorphism;
- d) [Ts] The set $\text{Dom}(X, Y)$ of all dominant holomorphic mappings $X \rightarrow Y$ is finite.

In Corollaries 1.3 — 1.5 below we preserve the assumptions of Theorem 1.2.

1.3. Corollary ([Ii 1, Theorem 6]; [Sa, Theorem 5.2]). The group $\text{Aut } Y$ of biregular automorphisms of Y is finite.

1.4. Corollary. $\text{Dom}(X, Y)$ is an open and closed subspace of the space $\text{Hol}(X, Y)$ of all holomorphic mappings $X \rightarrow Y$, endowed with the compact-open topology.

1.5. Corollary. Suppose that there exist mappings $\varphi \in \text{Dom}(X, Y)$ and $\psi \in \text{Dom}(Y, X)$. Then both φ and ψ are biregular isomorphisms.

1.6. Definition [Ur]. A complex manifold Y belongs to class C iff for any connected complex manifold Z and any holomorphic mapping $\varphi: Y \times Z \rightarrow Y$ such that for some $z_0 \in Z$ the mapping $\varphi_{z_0} := \varphi|_{Y \times \{z_0\}}$ belongs to the group $\text{Aut } Y$, it follows that $\varphi_z \equiv \varphi_{z_0}$ for every $z \in Z$.

Let us recall that for manifolds of class C the cancellation theorem and the theorem of the uniqueness of a primary product-decomposition hold [Ur] .

1.10. Theorem. *Let X and Y be smooth irreducible quasiprojective manifolds of hyperbolic type. Let for some k and $m \geq 0$ a biholomorphism $\Phi: X \times \mathbb{C}^k \rightarrow Y \times \mathbb{C}^m$ be given. Then $k = m$ and there exists a unique biregular isomorphism $\varphi: X \rightarrow Y$ making the following diagram commutative:*

$$\begin{array}{ccc}
 & \Phi & \\
 X \times \mathbb{C}^k & \rightarrow & Y \times \mathbb{C}^k \\
 \downarrow & & \downarrow \\
 X & \xrightarrow{\varphi} & Y
 \end{array}$$

In particular, Φ has a triangular form $\Phi(x, z) = (\varphi(x), \psi(x, z))$, where $(x, z) \in X \times \mathbb{C}^k$ and where for each $x \in X$ the mapping $\psi_x := \psi|_{\{x\} \times \mathbb{C}^k}$ belongs to the group $\text{Aut } \mathbb{C}^k$ of biregular automorphisms of \mathbb{C}^k .

Proof. By Theorem 1.2, a) X and Y are volume hyperbolic manifolds. Hence by Corollary 1.9 $\dim_{\mathbb{C}} X = \dim_{\mathbb{C}} Y$ and $k = m$. Let us consider the holomorphic mapping $\varphi := \pi_Y \circ \Phi|_{X \times \{0_k\}}: X \rightarrow Y$. We will show that φ is a dominant regular mapping.

The holomorphic mapping $f := \pi_Y \circ \Phi: X \times \mathbb{C}^k \rightarrow Y$ is dominant, therefore $\dim \text{Ker } df(u_0) = k$ for some $u_0 = (x_0, z_0) \in X \times \mathbb{C}^k$. Let $X' \subset X$ be an affine chart containing the point x_0 . There exists a regular mapping $\alpha: X' \rightarrow \mathbb{C}^k$ such that $\alpha(x_0) = u_0$ and the graph $\Gamma(\alpha) \subset X' \times \mathbb{C}^k$ is transversal to the subspace $\text{Ker } df(u_0)$. Let $\tilde{\alpha} := (\text{id}_{X'}, \alpha): X' \hookrightarrow X' \times \mathbb{C}^k$ be the embedding onto the graph $\Gamma(\alpha)$. It is easily seen that the mapping $\varphi_1 := f \circ \tilde{\alpha}: X' \rightarrow Y$ is dominant.

Consider a family of mappings $\varphi_t := f \circ \tilde{\alpha}_t$, where $\tilde{\alpha}_t := (\text{id}_{X'}, t\alpha)$, $t \in \mathbb{C}$. By Corollary 1.4 $\varphi_t \equiv \varphi_1$ for all $t \in \mathbb{C}$, and by Theorem 1.2, b) φ_1 is regular. Hence $\varphi = \varphi_0 = \varphi_1$ is a dominant regular mapping.

The same arguments applied to the mapping $\eta := \pi_X \circ \Phi^{-1}|_{Y \times \{0\}}: Y \rightarrow X$ show that η is a dominant regular mapping too. Therefore $\varphi: X \rightarrow Y$ is a biregular isomorphism (see Corollary 1.5).

By Corollary 1.4 the mapping $\varphi_z := f|_{X \times \{z\}}: X \rightarrow Y$, $z \in \mathbb{C}^k$, does not depend on z . Hence Φ has a triangular form $\Phi(x, z) = (\varphi(x), \psi(x, z))$. Since Φ is a biholomorphism the mapping $\psi_x: \mathbb{C}^k \rightarrow \mathbb{C}^k$ is biholomorphic for all $x \in \mathbb{C}^k$. This completes the proof.

1.7. Corollary. *Manifolds of hyperbolic type belong to class C.*

The next simple lemma and its corollary will allow us to distinguish the exotic complex algebraic structures on affine spaces, constructed in section 2 below, from the standard ones up to biholomorphisms.

1.8. Lemma. *Let X, Y and Z be connected complex manifolds, and Y be volume hyperbolic. If for some $k \geq 0$ there exists a dominant holomorphic mapping $\Phi: X \times \mathbb{C}^k \rightarrow Y \times Z$, then $\dim_{\mathbb{C}} X \geq \dim_{\mathbb{C}} Y$.*

Proof. Consider the dominant holomorphic mapping $\varphi := \pi_Y \circ \Phi: X \times \mathbb{C}^k \rightarrow Y$, where $\pi_Y: Y \times Z \rightarrow Y$ is the canonical projection. Let $\dim_{\mathbb{C}} X = n$, $\dim_{\mathbb{C}} Y = m$ and $m = n + r$. Suppose that $m > n$, i.e. $r > 0$. It is clear that $r \leq k$.

Let us fix a point $u_0 = (x_0, z_0) \in X \times \mathbb{C}^k$ such that $\text{rank } d\varphi(u_0) = m$. Restricting to a neighborhood of the point x_0 we may assume that $X = B^n$ is the unit ball in \mathbb{C}^n and x_0 is the origin.

For an arbitrary affine mapping $\alpha: X \times \mathbb{C}^r \rightarrow \mathbb{C}^{k-r}$ we shall denote by $\tilde{\alpha}$ the embedding onto the graph of α (i.e. $\tilde{\alpha} := (\text{id}_X \times \mathbb{C}^r, \alpha): X \times \mathbb{C}^r \rightarrow X \times \mathbb{C}^k$). Let $\pi': X \times \mathbb{C}^k \rightarrow X \times \mathbb{C}^r$ be the natural projection, and $u'_0 = \pi'(u_0)$.

Since $\text{codim Ker } d\varphi(u_0) = m$ there exists an affine mapping α as above such that $u_0 = \tilde{\alpha}(u'_0)$ and $\text{Im } d\tilde{\alpha}(u'_0) \cap \text{Ker } d\varphi(u_0) = \{0\}$. Therefore the mapping $\varphi \circ \tilde{\alpha}: X \times \mathbb{C}^r \rightarrow Y$ is a dominant mapping of manifolds of equal dimensions. This leads to a contradiction with the volume-decreasing property of holomorphic mappings with respect to the Eisenman — Kobayashi pseudovolume forms. Indeed, since by the above assumption $r > 0$, this form is identically zero on the manifold $X \times \mathbb{C}^r$, while by Theorem 1.2, a) it is nondegenerate on the manifold Y of hyperbolic type. Hence $r \leq 0$, i.e. $m \leq n$. **Q. E. D.**

1.9. Corollary. *Let X and Y be volume hyperbolic connected complex manifolds. If for some k and m the manifolds $X \times \mathbb{C}^k$ and $Y \times \mathbb{C}^m$ are biholomorphically equivalent, then $\dim_{\mathbb{C}} X = \dim_{\mathbb{C}} Y$. In particular, if $\dim_{\mathbb{C}} X > 0$, then for any natural numbers k and m the manifold $X \times \mathbb{C}^k$ is not biholomorphically equivalent to \mathbb{C}^m .*

In order to distinguish different exotic complex algebraic structures on \mathbb{R}^{2n} ($n > 2$) up to biholomorphisms we will use the following Strong Analytic Cancellation Theorem.

2. Exotic complex algebraic structures on affine spaces

As follows from the Ramanujam's characterization of the complex affine plane [Ra], any nonsingular complex algebraic surface, which is homeomorphic to \mathbb{C}^2 , in fact is isomorphic to \mathbb{C}^2 . The situation turns out to be different in higher dimensions.

2.1. Main Theorem. *For any $n \geq 3$ there exists a countable set of complex affine algebraic structures on \mathbb{R}^{2n} which are pairwise biholomorphically nonequivalent.*

Proof. The proof follows an idea of Ramanujam [Ra]. Let $\{X_k\}_{k \in \mathbb{N}}$ be a countable set of pairwise biregularly non-isomorphic smooth complex affine algebraic surfaces, each of which is topologically contractible and has hyperbolic type, i.e. its logarithmic Kodaira dimension equals 2. There are different constructions of such countable collections of surfaces; see [Su], [tDi Pe], [Za1], [Za2] or the Appendix to the present paper. As follows from the h-cobordism theorem, for each $k \in \mathbb{N}$ the smooth manifold $X_k \times \mathbb{R}^{2n-4}$ is diffeomorphic to \mathbb{R}^{2n} (see [Ra], [Mil]). This allows us to endow the manifold \mathbb{R}^{2n} with the countable set $\{X_k \times \mathbb{C}^{n-2}\}_{k \in \mathbb{N}}$ of complex affine algebraic structures. By Corollary 1.9 each of the manifolds $\{X_k \times \mathbb{C}^{n-2}\}_{k \in \mathbb{N}}$ is not biholomorphically equivalent to \mathbb{C}^n . By Theorem 1.10 for $k \neq m$ manifolds $X_k \times \mathbb{C}^{n-2}$ and $X_m \times \mathbb{C}^{n-2}$ are biholomorphically nonequivalent. This completes the proof.

2.2. Remarks. 1. The first example of a topologically contractible smooth algebraic surface X not isomorphic to \mathbb{C}^2 was constructed in [Ra]. This surface is of hyperbolic type [Ii 2]. It easily follows that $X \times \mathbb{C}$ is not biregularly isomorphic to \mathbb{C}^3 , hence one gets an example of exotic algebraic structure on \mathbb{C}^3 . In fact, $X \times \mathbb{C}$ is not biholomorphically equivalent to \mathbb{C}^3 (see Corollary 1.9). The latter answers a question, posed to me by J. Winkelmann (1988) (another, more complicated, proof of this fact was suggested by M. Chinak).

2. There exists a complete list of topologically contractible surfaces of logarithmic Kodaira dimension 1 [Gu Mi]. Using these surfaces in the same way as before one can introduce new complex algebraic structures on \mathbb{R}^{2n} for $n \geq 3$. The Strong Cancellation Theorem of Iitaka and Fujita [Ii Fu] allows one to distinguish these structures up to biregular isomorphisms. Moduli of surfaces lead to moduli of exotic structures. I do not know whether these structures are different up to biholomorphisms.

3. Let $X = \prod_{i=1}^n X_i$, $Y = \prod_{j=1}^m Y_j$ be two products of quasiprojective manifolds of hyperbolic type. By Corollary 1.7 and Urata's theorem [Ur] these decompositions are unique. Therefore, if $\varphi : X \rightarrow Y$ is an isomorphism, then $n = m$ and there exists a permutation $\sigma \in S_n$ such that $\varphi = \prod \varphi_i$, where $\varphi_i : X_i \rightarrow Y_{\sigma(i)}$, $i = 1, \dots, n$, are isomorphisms.

Thus, one could get additional exotic algebraic structures on affine spaces by looking at the manifolds $X \times \mathbb{C}^k$ ($k > 0$), where X is a product of topologically contractible surfaces of hyperbolic type.

2.3. Our next goal is to show the non-existence of a regular embedding of \mathbb{C}^{n-1} into "exotic \mathbb{C}^n 's" constructed above. It is known [Za 3] that a smooth acyclic complex algebraic surface* Y of hyperbolic type does not contain simply connected curves, i.e. there are no injective regular mappings $\mathbb{C} \rightarrow Y$. (Moreover, from a theorem of Nishino and Suzuki [Ni Suz] it follows that there are no injective proper holomorphic mappings $\mathbb{C} \rightarrow Y$.) This fact has the following generalization to higher dimensions :

2.4. **Theorem.** *Let Y be a nonsingular acyclic complex algebraic surface of hyperbolic type. Then for any natural k there are no injective regular mappings $\mathbb{C}^k \rightarrow Y \times \mathbb{C}^{k-1}$.*

2.5. **Remark.** It is known (see the addition to [Za 3]) that any acyclic surface Z of logarithmic Kodaira dimension 1 contains smooth simply connected curves (but it does not contain singular or reducible simply connected curves). Therefore $Z \times \mathbb{C}^k$ contains submanifolds isomorphic to \mathbb{C}^{k-1} .

Theorem 2.4 can be easily deduced from the following more general:

2.6. **Theorem.** *Let Y be a surface satisfying the assumptions of Theorem 2.4. Let X be a nonsingular irreducible simply connected quasiprojective variety of positive dimension k .*

a) *If $\Phi : X \rightarrow Y \times \mathbb{C}^{k-1}$ is an injective regular mapping, then the mapping $f := \pi_Y \circ \Phi : X \rightarrow Y$ is dominant.*

b) *Furthermore, if $X = Z \times \mathbb{C}^{k-2}$, then the mapping $\varphi := f | Z \times \{0\} : Z \rightarrow Y$ is dominant, and Φ has a triangular form $\Phi(z, v) = (\varphi(z), \psi(z, v))$, where $(z, v) \in Z \times \mathbb{C}^{k-2}$ and where $\psi_z := \psi | \{z\} \times \mathbb{C}^{k-2} : \mathbb{C}^{k-2} \rightarrow \mathbb{C}^{k-1}$ is an injective regular mapping for each $z \in Z$.*

* As usual, acyclicity of Y means that all reduced homology groups of Y with coefficients in \mathbb{Z} vanish.

Proof of a). Suppose that the mapping f is not dominant. Then its image is contained in some irreducible closed algebraic curve A in Y . The acyclic surface Y is affine [Fu 1, (2.5)], hence the curve A is affine too. Let $\nu : B \rightarrow A$ be the normalization and $\delta : U \rightarrow B$ be the universal covering map. Since X is simply connected there exist covering mappings $f_\nu : X \rightarrow B$ ($\nu \circ f_\nu = f$) and $f_\delta : X \rightarrow U$ ($\delta \circ f_\delta = f_\nu$). If A is a hyperbolic curve, then U must be the unit disc and hence the bounded holomorphic function $f_\delta : X \rightarrow U$ is constant. This is impossible, since the constancy of f under the assumptions on the dimensions contradicts the injectivity of Φ . The case when $B = C^* := C \setminus \{0\}$ can also be excluded, since in this case the non-constant regular function $f_\nu : X \rightarrow C^*$ on the simply connected variety X would have a logarithm, — which is impossible. Therefore, $B = C$.

Let us show that the normalization mapping $\nu : C \rightarrow A$ is injective. This will lead to a contradiction with Theorem 9.1 in [Za 3], quoted above, which in particular states that an acyclic surface Y of hyperbolic type does not contain simply connected curves.

Suppose that ν is not injective, i.e. $\nu(z_1) = \nu(z_2) = a_0 \in A$ for some $z_1, z_2 \in C$, where $z_1 \neq z_2$. Let $Z_i = f_\nu^{-1}(z_i)$, $g = \pi_{C^{k-1}} \circ \Phi : X \rightarrow C^{k-1}$ and $\eta_i = g|Z_i$, $i = 1, 2$. Since $f|Z_i = \nu(z_i) = a_0$ and Φ is injective, the mappings η_i would also be injective. These regular mappings are equidimensional and therefore dominant, hence the intersection of their images is nonempty, i.e. $\eta_1(x_1) = \eta_2(x_2)$ for some $x_i \in Z_i$. Finally, this implies that $\Phi(x_1) = \Phi(x_2)$, which contradicts the assumption of injectivity of Φ . This completes the proof of a).

Proof of b). It follows from a) that $k \geq 2$ and for $k = 2$ that the mapping $\varphi = f$ is dominant. We shall now consider the case when $k > 2$. Suppose that the mapping φ is not dominant, and therefore its image is contained in an irreducible curve A in Y . First consider the case when φ is non-constant. Let D be a generic curve in the surface Z and L be an arbitrary affine line passing through the origin in C^{k-2} . Consider the surface $D \times L \subset X = Z \times C^{k-2}$. Since Y is a surface of general type, it is clear that the restriction $f|D \times L : D \times L \rightarrow Y$ is degenerate. Therefore its image is contained in an irreducible curve, which coincides with the Zariski closure of the curve $f(D \times \{0\}) = \varphi(D)$ and hence with the curve A (recall that $\varphi|D$ is non-constant). The genericity of D and L implies that $f(X) \subset A$. Therefore, f would be a degenerate mapping in contradiction with what has been proven in a).

Now consider the case, when φ is constant. Let $\varphi(Z) = \{y_0\} \subset Y$ and let E be a generic closed algebraic curve in Y , which does not pass through the point y_0 . Since f is dominant (as was proved in a)) and E is generic, there exists a curve $D \subset f^{-1}(E)$ such that the restriction $f|D : D \rightarrow E$ is dominant.

Let \mathbf{S} be the developed surface in \mathbf{X} containing the curve \mathbf{D} , and let $\lambda : \mathbf{D} \times \mathbf{C} \rightarrow \mathbf{S}$ be the natural regular mapping

$$\lambda : \mathbf{D} \times \mathbf{C} \ni (\mathbf{d}, \xi) \mapsto \left(\pi_{\mathbf{Z}}(\mathbf{d}), \xi \pi_{\mathbf{C}^{k-1}}(\mathbf{d}) \right) \in \mathbf{S} .$$

Consider the mapping $\mathbf{f} \circ \lambda : \mathbf{D} \times \mathbf{C} \rightarrow \mathbf{Y}$. Since \mathbf{Y} is of hyperbolic type, this mapping must be degenerate and its image has to be contained in a closed irreducible curve in \mathbf{Y} , which evidently must coincide with \mathbf{E} . But then $\mathbf{y}_0 = \varphi(\mathbf{d}) = \mathbf{f}(\mathbf{d}, \mathbf{0}) \in \mathbf{E}$, contradicting to the choice of the curve \mathbf{E} .

Thus, the mapping φ is dominant. The proof of the other statements in b) follows that of the analogues statements of Theorem 1.10. **Q. E. D.**

APPENDIX

Two constructions of smooth topologically contractible affine surfaces of hyperbolic type

A 1. Generalities on acyclic surfaces

All surfaces here assumed to be quasiprojective, nonsingular and irreducible. The next theorem will be the most useful in the constructions below. It actually was established in [Ra] and supplemented in [Fu 1] (see also [Gu 1] , [Gu 2]) .

A 1.1. Theorem (Ramanujam - Fujita). *Consider a surface $X = V \setminus D$, where V is a nonsingular projective surface and D is a curve in V . The surface X is acyclic iff the following two conditions are fulfilled:*

- 1) V and D are connected and simply connected;
- 2) The embedding $i: D \hookrightarrow V$ induces the isomorphism

$$i_* : H_2(D; \mathbb{Z}) \rightarrow H_2(V; \mathbb{Z}) .$$

In addition:

A 1.2. Lemma (Fujita [Fu 1, (2.5)]) . *Any nonsingular acyclic surface is affine.*

The following theorem had been conjectured first by A. Van de Ven [VdV] .

A 1.3. Rationality Theorem (Gurjar - Shastri [Gu Sha]). *Any nonsingular acyclic surface is rational.*

Let $e(X)$ be the Euler characteristic of the surface X , $R(X) = H^0(X, O_X)$ the algebra of regular functions on X and $R^*(X)$ its group of invertible elements. Recall the following:

A 1.4. Definition [Za 3] . *A nonsingular affine surface X is called simple iff the following two conditions are fulfilled:*

- 1') $e(X) = 1$;
- 2') $R(X)$ is UFD (a unique factorization domain) and $R^*(X) = \mathbb{C}$.

The next theorem gives an inner characterization of acyclicity.

A 1.5. Theorem. *A nonsingular surface is acyclic if and only if it is simple.*

Proof. By [Fu, (2.5) — (2.9)] , condition 2') is equivalent to condition 2) of Theorem A 1.1. For an acyclic surface X , condition 1') is fulfilled and, by Fujita's Lemma A 1.2 , X is affine. The 'only if' part follows immediately from these remarks.

Let us further assume that X is simple. Since X is affine and therefore Stein, $H_4(X; \mathbb{Z}) = H_3(X; \mathbb{Z}) = 0$ and $H_2(X; \mathbb{Z})$ is a free group. Hence by 1') $b_1(X) = b_2(X)$. Now the acyclicity of X follows from the equality $H_1(X; \mathbb{Z}) = 0$, which is proven in Lemma 2.2 in [Gu Mi] . Q. E. D.

A 1.6. Rational trees on rational surfaces

Let V be a nonsingular completion of an acyclic surface $X = V \setminus D$. Then, by the Gurjar — Shastri Theorem A 1.3 , V is a rational surface, and by the Ramanujam — Fujita Theorem A 1.1, the curve D is simply connected. In particular, all its irreducible components are rational curves. Resolving singularities of D one can assume D to be of simple normal crossing type (or *an SNC-curve* for short). In the latter case the pair (V, D) is called *an SNC-completion of X* . The *weighted dual graph* $*\Gamma_D$ of D is a tree, and we will call D itself *a rational tree*. An SNC-completion (V, D) of X is called *minimal* if the graph Γ_D does not contain linear or end (-1)-vertices, i.e. vertices of weight -1 and a valency not exceeding 2. A minimal completion always exists, but it could be non-unique.

The next theorem gives a useful characterization of \mathbb{C}^2 as an acyclic surface.

A 1.7. Ramanujam's Theorem [Ra] . *Let (V, D) be a minimal SNC-completion of a nonsingular acyclic surface X . Then X is isomorphic to \mathbb{C}^2 if and only if the graph Γ_D is linear.*

All possible dual graphs (weighted linear chains) of minimal SNC-completions of \mathbb{C}^2 are described in [Ra] and, in more detail, in [Mo] .

* i.e. the graph, whose vertices correspond to the irreducible components of D , wedges correspond to intersection points of these components and the weight of a vertex is the self-intersection index of the corresponding component

A 1.8. 'Cutting cycle' construction

Let W be a nonsingular rational projective surface and B be a connected SNC-curve in W with rational irreducible components $\{B_i\}_{i=1,\dots,m}$.

Let δ be a cycle of the dual graph Γ_B of B and $[B_\alpha, B_\beta]$ be a wedge in δ , which corresponds to the intersection point z_0 of the curves B_α, B_β . Choose a coordinate chart (x, y) at z_0 such that locally $B_\alpha = \{x = 0\}, B_\beta = \{y = 0\}$.

Consider the meromorphic function $f := \frac{x^n}{y^m}$, where n, m are coprime natural numbers. Let $\pi_{n,m} : V \rightarrow W$ be the minimal resolution of the point z_0 of indeterminacy of the function f . Then $\gamma_{n,m} := \pi_{n,m}^{-1}(z_0)$ is a linear chain of rational curves. By the same symbol $\gamma_{n,m}$ we will denote its dual graph. Let v be the last curve gluing by $\pi_{n,m}^{-1}$, and let $\gamma'_{n,m}, \gamma''_{n,m}$ be the linear branches of the graph $\gamma_{n,m}$ at the vertex v .

Consider further the curve $D := \pi_{n,m}^{-1}(B) \ominus v$ in V . The graph Γ_D is obtained from the graph Γ_B by changing the wedge $[B_\alpha, B_\beta]$ by the union of two disjoint branches $\gamma'_{n,m}, \gamma''_{n,m}$:

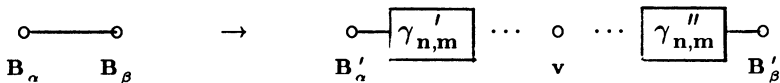

Definition [tDi Pe]. The above procedure of changing the pair (W, B) by the pair (V, D) is called *cutting a cycle*.

A 1.9. The graphs $\gamma_{n,m}$

In the following we need the description of the graph $\gamma_{n,m}$. Consider the continued fraction development $\frac{m}{n} = [q_0, q_1, \dots, q_t]$ (here $q_t > 1$ if $t > 0$). If $t = 2k$ is even, then $\gamma_{n,m}$ is the following graph:

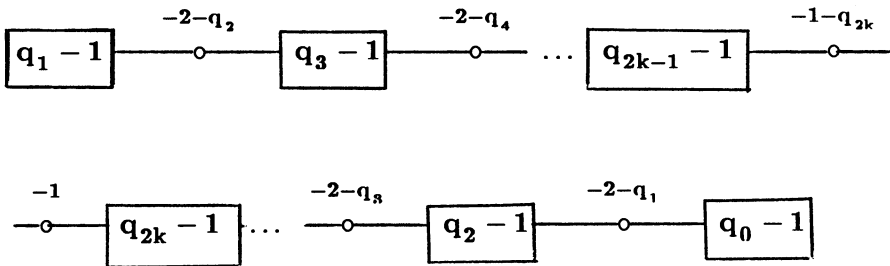

Here by $\boxed{\mathbf{k}}$ we denote the weighted linear chain of length \mathbf{k} of the form :

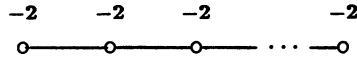

If $t = 2k + 1$ is odd, the graph $\gamma_{n, m}$ has the following form:

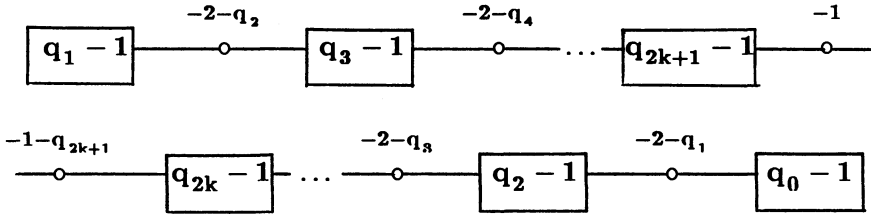

It is clear that $\gamma'_{n,m} = \gamma''_{m,n}$ and vice versa. The vertex $B'_\alpha (B'_\beta)$ of the weighted graph $\Gamma_{B'}$ has the weight

$$B'^2_\alpha = B_\alpha^2 - \lfloor \frac{m}{n} \rfloor - \sigma(m) \quad (B'^2_\beta = B_\beta^2 - \lfloor \frac{n}{m} \rfloor - \sigma(n)),$$

where

$$\sigma(k) := \begin{cases} 1, & k > 1 \\ 0, & k = 1 \end{cases} .$$

Furthermore, for the divisors B^*_α, B^*_β we have:

$$B^*_\alpha = mv + \dots, \quad B^*_\beta = nv + \dots .$$

A 1.10. Construction of acyclic surfaces by cutting cycles

Let the pair (W, B) as in A 1.8 in addition has the following properties:

- i) B is connected and the components $\{B_i\}_{i=1, \dots, m}$ of B generate $\text{Pic } W$;
- ii) $m = \rho + k$, where $\rho = \text{rank Pic } W$ and $k = b_1(B) = b_1(\Gamma_B)$.

Choose k different wedges $[B_{r_i}, B_{s_i}]$, $i = 1, \dots, k$, of Γ_B on k basic cycles $\delta_1, \dots, \delta_k$ respectively and numerical data $\{(n_i, m_i)\}_{i=1, \dots, k}$, consisting

of the pairs of relatively prime natural numbers. Cutting cycles in the chosen wedges according to this numerical data we get a new pair (V, D) , where V is a smooth rational surface with a rational tree D , and the birational morphism $\pi := \prod \pi_{n_i, m_i} : V \rightarrow W$ such that $\pi(D) = B$. Let z_1, \dots, z_k be the double points of the curve B , which correspond to the chosen wedges of Γ_B and v_1, \dots, v_k be (-1) -curves, which are the last ones gluing by π^{-1} over these points respectively. Then $D = B' \cup E$, where B' is the proper pre-image of B and E consists of the components of the exceptional locus of π^{-1} , excluding v_1, \dots, v_k .

Let $\text{Pic}W$ be freely generated by the classes of irreducible curves C_1, \dots, C_ρ . Then $\text{Pic}V$ is freely generated by the classes of the curves $(C'_1, \dots, C'_\rho, v_1, \dots, v_k)$ and the components of E . Denote by S the $m \times m$ matrix of an expansion of the system of vectors (B'_1, \dots, B'_m) by the system $(C'_1, \dots, C'_\rho, v_1, \dots, v_k)$ modulo the subgroup of $\text{Pic}W$ generated by the components of E . The ' v_i -line' of S contains two nonzero entries $s_{i,r_i} = m_i, s_{i,s_i} = n_i$ only (see A 1.9).

By Theorem A 1.4 the surface $X := V \setminus D$ is acyclic iff the matrix S is unimodular. In particular cases, considered in section A 3 below we have $C_i = B_i, i = 1, \dots, \rho$, and the condition equivalent to the above one is the unimodularity of the $k \times k$ submatrix T of S of the expansion of the system $(B'_{\rho+1}, \dots, B'_m)$ by the system (v_1, \dots, v_k) modulo the subgroup of $\text{Pic}W$, generated by (C'_1, \dots, C'_ρ) and the components of E .

A 2. Absolutely minimal completions

A 2.1. Definition [Za 1]. *Let V be a nonsingular projective surface and D be an SNC-curve in V . The pair (V, D) will be called **absolutely minimal** iff the following holds: if (V', D') is an other SNC-pair and $\varphi : V' \rightarrow V$ is a birational mapping such that the restriction $\varphi | V' \setminus D'$ is an isomorphism of $V' \setminus D'$ onto $V \setminus D$, then φ is actually a morphism.*

This means that an absolutely minimal completion (V, D) of a given surface

$$X := V \setminus D$$

is dominated by any other of its SNC-completions. In particular, if an absolutely minimal completion exists it is unique.

A 2.2. Definition [Za 1]. A weighted graph Γ will be called *absolutely minimal* iff the weight of any of its at most linear (i.e. linear or end) vertices does not exceed -2 .

It is clear that Γ is absolutely minimal iff it is minimal and has no linear or end vertex of a non-negative weight.

A 2.3. Proposition. Let \mathbf{D} be an SNC-curve with rational components in a nonsingular projective surface \mathbf{V} . The pair (\mathbf{V}, \mathbf{D}) is absolutely minimal if and only if the dual graph $\Gamma_{\mathbf{D}}$ is absolutely minimal.

Proof. Assume that $\Gamma_{\mathbf{D}}$ is not absolutely minimal. Let \mathbf{v} be an at most linear vertex of $\Gamma_{\mathbf{D}}$ of weight $\mathbf{n} \geq -1$. After $\mathbf{n} + 1$ successive blowing ups in an incidental wedge, \mathbf{v} will be an at most linear (-1) -vertex. Then the contraction of \mathbf{v} gives a new SNC-pair $(\mathbf{V}', \mathbf{D}')$, and the composition of the above transformations is a birational mapping $\pi : \mathbf{V} \rightarrow \mathbf{V}'$, which induces an isomorphism $\mathbf{V} \setminus \mathbf{D} \rightarrow \mathbf{V}' \setminus \mathbf{D}'$. The inverse $\varphi := \pi^{-1} : \mathbf{V}' \rightarrow \mathbf{V}$ is not a morphism, and hence the pair (\mathbf{V}, \mathbf{D}) is not absolutely minimal.

The converse follows from Lemma 4 of [Gi]. Q.E.D.

A 2.4. Theorem. Let \mathbf{X} be an acyclic surface of hyperbolic type. Then \mathbf{X} has a unique minimal SNC-completion (\mathbf{V}, \mathbf{D}) , and this completion is absolutely minimal.

Proof. We shall prove that any minimal SNC-completion of \mathbf{X} is in fact absolutely minimal, which suffices. Suppose that there exists a minimal SNC-completion (\mathbf{V}, \mathbf{D}) of \mathbf{X} which is not absolutely minimal. Then by A 2.3 the graph $\Gamma_{\mathbf{D}}$ must have an at most linear vertex \mathbf{v} of a non-negative weight \mathbf{n} . After \mathbf{n} successive blowing ups in an incidental wedge one can assume that $\mathbf{n} = 0$. By Theorem A 1.3 the surface \mathbf{V} is rational and so, applying the Riemann-Roch Theorem, we conclude that the curve \mathbf{v} varies in a linear pencil, which defines a morphism $\pi : \mathbf{V} \rightarrow \mathbf{P}^1$ with a rational generic fibre \mathbf{F} . Since $\mathbf{F} \cdot \mathbf{D} = \mathbf{v} \cdot \mathbf{D} \leq 2$, the generic fibre $\Gamma = \mathbf{F} \setminus \mathbf{D}$ of the restriction $\pi|_{\mathbf{X}} : \mathbf{X} \rightarrow \mathbf{P}^1$ is isomorphic either to \mathbb{C} (if \mathbf{v} is an end vertex) or to $\mathbb{C}^* = \mathbb{C} \setminus \{0\}$ (if \mathbf{v} is a linear one). By the well known inequality [Pi 1, Theorem 4] we have:

$$\bar{k}(\mathbf{X}) \leq \bar{k}(\Gamma) + \dim \mathbf{P}^1 \leq 1.$$

This contradicts to the assumption that \mathbf{X} is of hyperbolic type. Q.E.D.

A 2.5. Remark. If an acyclic surface \mathbf{X} has an absolutely minimal completion (\mathbf{V}, \mathbf{D}) , then the class of combinatorial equivalence of the graph $\Gamma_{\mathbf{D}}$ is an invariant

of the isomorphism type of X . This will be used further in order to distinguish such surfaces up to isomorphism.

A 3. Constructions of examples

A 3.1. The surfaces X_T

Consider the quadric $Q = P^1 \times P^1$ as a completion of C^2 with coordinates (x, y) by a pair of projective lines $e_0 := \{y = \infty\}$ and $e_1 := \{x = \infty\}$. Denote by c_0, c_1, l_0, l_1 the generators of the quadric Q , given in affine coordinates by the equations $y = 0, y = 1, x = 0, x = 1$ respectively. Let B be the union of six rational curves $e_0, e_1, c_0, c_1, l_0, l_1$ in Q . Fix four intersection points $z_{ij} = (i, j)$ and numerical data $\{(n_{ij}, m_{ij})\}, i, j = 0, 1$, such that the matrix

$$T := \begin{pmatrix} m_{00} & 0 & n_{00} & 0 \\ m_{10} & 0 & 0 & n_{10} \\ 0 & m_{01} & n_{01} & 0 \\ 0 & m_{11} & 0 & n_{11} \end{pmatrix}$$

is unimodular. Applying the cutting cycle procedure to the pair (Q, B) in four given points according to this numerical data, we obtain an SNC-pair (V_T, D_T) , which satisfies to the conditions of A. 1.10. Therefore the surface $X_T := V_T \setminus D_T$ is acyclic.

A 3.2. Lemma. *The dual graph Γ_T of the curve D_T is absolutely minimal and has the following form:*

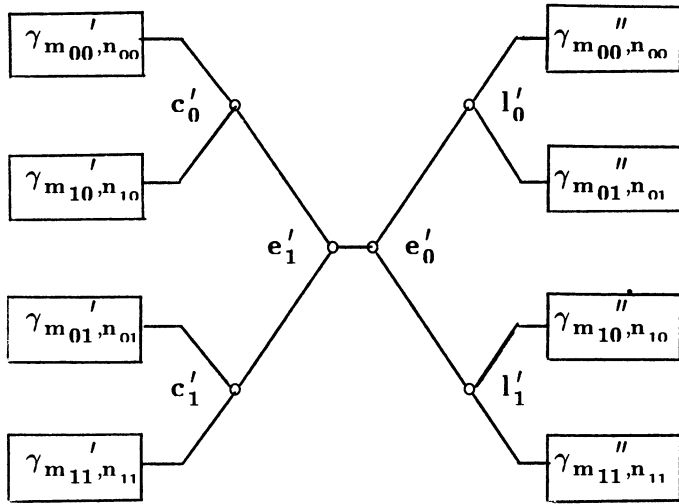

A 3.3. The surfaces X_θ

Let l_1, c_s , where s is an odd natural number, be the curves in the quadric Q , given in affine coordinates by equations $x = 1, y^2 = x^s$ respectively. Let $\pi : W \rightarrow Q$ be the minimal resolution of singularities of the curve $d_s := e_0 \cup \cup e_1 \cup l_1 \cup c_s$ and $B_s := \pi^{-1}(d_s)$.

Let z_0, z_1 be two points of intersection of the curves l_1, c_s . Fix numerical data $\{(n_i, m_i)\}, i = 0, 1$, such that the matrix

$$T := \begin{pmatrix} m_0 & n_0 \\ m_1 & n_1 \end{pmatrix}$$

is unimodular. Set $\theta := (s, T)$. Applying the cutting cycle procedure to the pair (W, B_s) over the points z_0, z_1 according to this numerical data, we obtain a pair (V_θ, D_θ) , which satisfies the conditions of A 1.10. So, we get the second series of acyclic surfaces $X_\theta := V_\theta \setminus D_\theta$. We omit calculations, which lead to the following lemma.

A 3.4. Lemma. *Let Γ_θ be the minimization of the dual graph of the curve D_θ . Then*

- a) Γ_θ is a linear graph iff $s = 1$ and $(n_i, m_i) = (1, 1)$ for $i = 0$ or for $i = 1$.
- b) In the case, when $s = 1$ and $(n_i, m_i) \neq (1, 1)$ for $i = 0, 1$, the graph Γ_θ is absolutely minimal and has the following form:

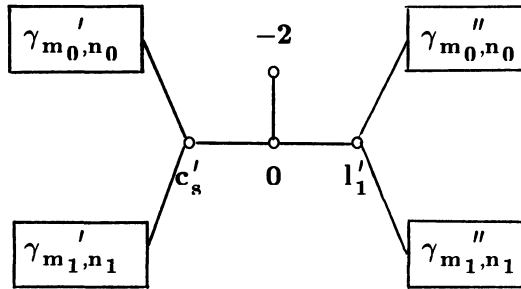

c) In the case, when $s = 2\tau + 1 > 1$, Γ_θ is absolutely minimal and has the following form:

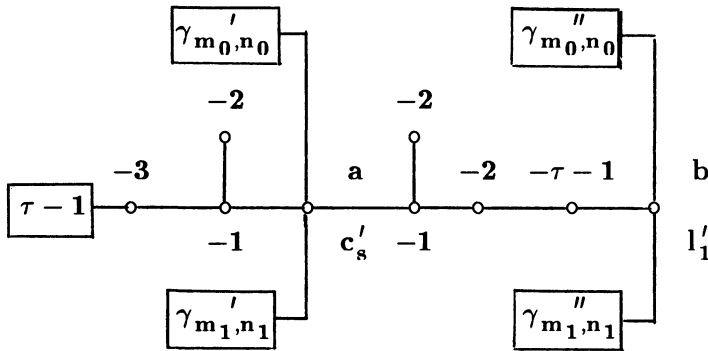

A 3.5. Remarks. 1. As follows from Ramanujam's Theorem A 1.7 , in case a), and only in this case, the surface X_θ is isomorphic to C^2 .

2. There is a countable set of pairwise non-isomorphic surfaces X_T (or X_θ) since there is such a set of pairwise non-equivalent graphs Γ_T (or Γ_θ) (see A 2.5) . The complete description of all isomorphisms on the set $\{X_T, X_\theta\}$ is given in [Za 1] , [Za 2] . It turned out that two surfaces from this set are isomorphic iff the corresponding dual graphs are combinatorially equivalent. In general, this is not true for arbitrary acyclic surfaces.

3. It is worth mentioning that the surface in Ramanujam's original example [Ra] is isomorphic to X_{θ^0} , where $\theta^0 = (s^0, T^0) := (3, \begin{pmatrix} 1 & 1 \\ 1 & 2 \end{pmatrix})$, but their constructions are different.

4. The canonical projection $Q = P^1 \times P^1 \rightarrow P^1$ onto the first factor induces families of curves $X_T \rightarrow C$, $X_\theta \rightarrow C$ with generic fibers isomorphic to $C^{**} := C \setminus \{0; 1\}$. As follows from [Za 1] , [Za 2], they are the only isotrivial families of curves, i.e. families with isomorphic generic fibres, with the base C on acyclic surfaces non-isomorphic to C^2 . Furthermore, in [Za 1] , [Za 2] the

list of isotrivial polynomials on \mathbb{C}^2 , which partially had been obtained in [Za 4], [Ka] , was completed.

A 4. Contractibility of the surfaces X_T , X_θ

A 4.1. Proposition. *Each of the surfaces X_T , X_θ , constructed in A 3 , is topologically contractible.*

We precede the proof with some general remarks.

A 4.2. Since the surfaces X_T , X_θ are acyclic, it is enough to show that they are simply connected. This is done for the surfaces X_T in Lemma A 4.6 below. In the case of the surfaces X_θ the proof is something more delicate, see [Za 1] , and will be omitted.

A 4.3. Let H be an irreducible curve in a smooth surface X and $x_0 \in X \setminus H$ be a distinguished point. Then there is a naturally defined class of conjugate elements $[\lambda_H] \in \text{Ker}(\pi_1(X \setminus H, x_0) \rightarrow \pi_1(X, x_0))$, called *vanishing loops of H* . For a pair of irreducible curves H' , H'' , intersecting transversely in smooth points, their vanishing loops can be chosen commuting. If $X = V \setminus D$, where D is a curve in a smooth complete surface V , and H is smooth and intersects with D transversely, then one has the exact sequence

$$1 \rightarrow N \rightarrow \pi_1(X \setminus H) \rightarrow \pi_1(X) \rightarrow 1 ,$$

where N is generated by vanishing loops of H [Fu 1, (4.18)] .

A 4.4. Lemma [Fu 1, (7.18)] . *Let a pair (V, D) be obtained from an SNC-pair (W, B) by applying the cutting cycle procedure over a point z_0 of intersection of two components B_1, B_2 of B according to the numerical data (n, m) . Let $H = v$ be the last gluing curve over z_0 . Then for suitably chosen commuting vanishing loops $\lambda_i := \lambda_{B_i}$, $i = 1, 2$, the relation $[\lambda_H] = [\lambda_1]^n [\lambda_2]^m$ holds.*

The next lemma follows immediately from A 4.3 and A 4.4 .

A 4.5. Lemma. *Let $X = V \setminus D$ be an acyclic surface, obtained by cutting cycles construction as in A 1.10. Let under the notations of A 1.10 $Y := X \setminus v = V \setminus \pi^{-1}(B) = W \setminus B$, where $v := \cup_{i=1}^k v_i$. Then $\pi_1(X) = \pi_1(Y) / N$,*

where N is a normal subgroup of $\pi_1(Y)$ generated by the elements of the form $\left[\lambda_{B_{r_i}} \right]^{m_i} \left[\lambda_{B_{s_i}} \right]^{n_i}$, where the vanishing loops $\left[\lambda_{B_{r_i}} \right]$, $\left[\lambda_{B_{s_i}} \right]$ commute, $i = 1, \dots, k$.

For the surfaces X_T , as was mentioned in A 4.2, Proposition A 4.1 follows from the next lemma.

A 4.6. Lemma. *For any unimodular matrix T as in A 3.1 the surface X_T is simply connected.*

Proof. Let $Y := Q \setminus d$ be the complement of the union d of six generators of the quadric (see A 3.1). Then $\pi_1(Y) = F_2 \times F_2$, where F_2 is a free group with two generators, has the following system of four generators:

$$a_i := \left[\lambda_{l_i} \right], b_j := \left[\lambda_{c_j} \right], i, j = 0, 1,$$

where $[a_i, b_j] = 1$ for any $i, j = 0, 1$. By Lemma A 4.5 the group $\pi_1(X_T)$ has the following corepresentation:

$$\pi_1(X_T) = \left[a_0, a_1, b_0, b_1 \mid [a_i, b_j] = 1, a_i^{m_{ij}} b_j^{n_{ij}} = 1, i, j = 0, 1 \right].$$

Raising both sides of the latter equation to the power $n_{1-i, j}$ we get :

$$a_0^{m_{00}n_{10}} = a_1^{m_{10}n_{00}}, \quad a_0^{m_{01}n_{11}} = a_1^{m_{11}n_{01}}.$$

Further, raising these equations to the powers $m_{11}n_{01}$, $m_{10}n_{00}$ respectively, we come to a consequence:

$$a_0^{m_{00}m_{11}n_{01}n_{10}} = a_0^{m_{01}m_{10}n_{00}n_{11}}, \quad \text{or} \quad a_0^{\det T} = 1.$$

Since T is a unimodular matrix, $a_0 = 1$. In the same way one can show that $a_1 = b_0 = b_1 = 1$, i.e. $\pi_1(X_T) = 1$. **Q.E.D.**

A 5. Logarithmic Kodaira dimensions of the surfaces X_T, X_θ

Here we shall show that most of the surfaces X_T, X_θ constructed above are of hyperbolic type. This will be done in two ways. The simplest one is based on the following facts.

A 5.1. Theorem of Miyanishi-Sugie-Fujita (see [Fu 2]). *Let X be an acyclic surface. Then $\bar{k}(X) = -\infty$ if and only if X is isomorphic to \mathbb{C}^2 .*

A 5.2. Theorem ([Fu 1, (8.70)]; see also [Gu Mi]). *There exists no acyclic surface X with $\bar{k}(X) = 0$.*

The complete list of acyclic surfaces with $\bar{k}(X) = 1$ was obtained in [Gu Mi, § 3]. To formulate this result (in a particular case of topologically contracted surfaces) we need the following notion.

A 5.3. Definition. *Let (W, B) be an SNC-pair. Fix a smooth point $b \in B$. Let v be the exceptional curve of the blowing up $\pi : V \rightarrow W$ at b and $D := B' = \pi^{-1}(B) \ominus v$. The procedure of replacing the pair (W, B) by the pair (V, D) is called a *half-point attachment at the point b* [Fu 1].*

By a k -iterated half-point attachment we mean the following extension of this procedure: blow up in a point $b = b_1$, then once more in a point $b_2 \in E_1 \setminus B'$, where E_1 is the gluing curve, and so on k times; put $D := \pi^{-1}(B) \ominus v$, where $\pi : V \rightarrow W$ is the composition of these k blowing ups and $v = E_k$ is the last gluing curve.

A 5.4. Theorem [Gu Mi, Theorem 3]. *Any topologically contracted surface X with $\bar{k}(X) = 1$ can be obtained in the following way. Let $W = \Sigma(1)$ be the Hirzebruch surface (which is a blowing up of \mathbb{P}^2 in a point). Let the SNC-curve B in W be the union of two disjoint sections H_0 and H_1 of the natural projection $\Sigma(1) \rightarrow \mathbb{P}^1$ with $H_0^2 = -1$ and $H_1^2 = 1$, and three distinguished fibres F_0, F_1, F_∞ . Let z_i be the intersection points of the curves F_i and H_1 , $i = 0, 1$. Fix a natural number k and numerical data (m_i, n_i) , $i = 0, 1$, such that $n_i < m_i$ and $m_0 n_1 + m_1 n_0 - m_0 m_1 = \pm 1$. Then $X := V \setminus D$, where an SNC-pair (V, D) is obtained from the pair (W, B) by the k -iterated half-point attachment at a point of the fibre F_∞ and the cutting cycles procedure over the points z_0, z_1 according to the given numerical data.*

A 5.5. Corollary. *Let (V_{\min}, D_{\min}) be a minimal SNC-completion of a surface X as above. Then the dual graph of D_{\min} is absolutely minimal and has the following form:*

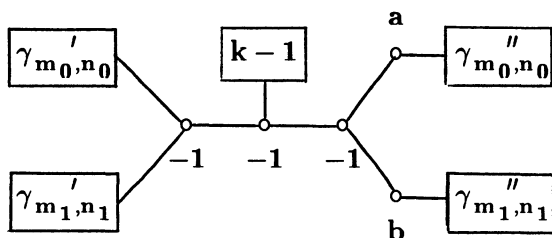

if $k > 1$, and

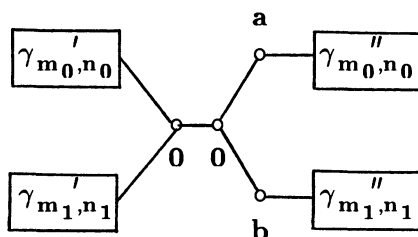

if $k = 1$ (here $a, b \leq -2$).

The next theorem is the main result of this section.

A 5.6. Theorem. *There exists a countable set of pairwise non-isomorphic surfaces X_T (X_θ) of hyperbolic type.*

Proof. It is easily seen that most of the dual graphs Γ_T, Γ_θ (see A 3.2, A 3.4) are not equivalent to any of the above graphs, and are pairwise non-equivalent. So, the corresponding surfaces X_T, X_θ , which by A 4.1 are topologically contractible, are pairwise non-isomorphic and are not isomorphic to any of contractible surfaces of logarithmic Kodaira dimension less than 2 (see remark A 2.5). Hence they are of hyperbolic type. **Q. E. D.**

Another approach to the direct calculation of logarithmic Kodaira dimensions of the surfaces X_T, X_θ is based on the following facts.

A 5.7. Kawamata's Theorem [Kaw]. *Let (V, D) be an SNC-completion of a surface $X = V \setminus D$ with $\bar{k}(X) \geq 0$. Consider the Zariski decomposition $K + D = H + N$, where $K := K_V$ is the canonical divisor and $H = (K + D)^+, N = (K + D)^-$. Then*

- i) $\bar{k}(X) = 0$ iff $H = 0$;
- ii) $\bar{k}(X) = 1$ iff $H \neq 0$ and $H^2 = 0$;
- iii) $\bar{k}(X) = 2$ iff $H^2 > 0$.

A 5.8. Since H and N are orthogonal we have:

$$H^2 = (K + D)^2 - N^2 = K(K + D) + D(K + D) - N^2 .$$

Here $D(K + D) = -2$ if D is a rational tree, — indeed, in this case $\pi_a(D) = 0$. The following simple lemma allows one to calculate $K(K + D)$ in our examples.

A 5.9. Lemma. a) *The value of $K(K + D)$ does not change under blowing down of a (-1) -vertex E of the graph Γ_D if E is a linear vertex, it increases by 1 if E is an end vertex and increases by 2 if E is an isolated vertex.*

b) *Let v be a component of a curve D' and $D := D' \ominus v$. Then*

$$K(K + D) = K(K + D') + v^2 + 2 .$$

In particular, after deleting a (-1) -component v of D' the value of $K(K + D')$ increases by 1 .

A 5.10. Corollary. *Let a pair (V, D) be obtained from an SNC-pair (W, B) as a result of cutting of k cycles. Then*

$$K_V(K_V + D) = K_W(K_W + B) + k .$$

In particular, for the minimal completion (V_T, D_T) of the surface X_T we have $K_T(K_T + D_T) = 0$, where $K_T := K_{V_T}$.

Indeed, the pair (V_T, D_T) is obtained from the pair (Q, d) by cutting four cycles (see A 3.1) , and $K_Q(K_Q + d) = -2(e_0 + e_1) = -4$.

A 5.11. Remark. In the same way one can easily check, that $K_\theta^{\min}(K_\theta^{\min} + D_\theta^{\min}) = 0$ for the minimal SNC-completion $(V_\theta^{\min}, D_\theta^{\min})$ of the surface X_θ , if this surface is not isomorphic to \mathbb{C}^2 (see [Za1]) .

A 5.12. Corollary. *Let (V, D) be a minimal SNC-completion of a surface $X = X_T$ or $X = X_\theta$, where X_θ is not isomorphic to \mathbb{C}^2 . Then $H^2 = -2 - N^2$. Therefore X is of hyperbolic type iff $N^2 < -2$.*

To calculate the value of N^2 we make use of so called *theory of peeling* (see [Fu 1] , [Mi Tsu]) , which in some cases allows one to find the Zariski

decomposition $K + D = H + N$ explicitly. We recall some necessary notions and facts.

A 5.13. Let D be an SNC-curve with rational components in a smooth complete surface V . A *twig* L of D is an extremal linear branch of the dual graph Γ_D , i.e. a linear branch $[D_1, \dots, D_k]$ of the form

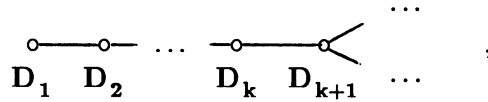

where D_1 is an end vertex Γ_D , called a *tip of L*, and D_{k+1} is a branching point of Γ_D . L is called an *admissible twig* iff $D_i^2 \leq -2$ for every $i = 1, \dots, k$, or equivalently, iff L is minimal and its bilinear form is negative definite. For an admissible twig L the *bark of L* is defined to be the effective \mathbb{Q} -divisor $Bk(L) := \sum_{i=1}^k \alpha_i D_i$, uniquely determined by the equations

$$D_i Bk(L) = D_i(K + D) = \begin{cases} -1, & i = 1 \\ 0, & i = 2, \dots, k \end{cases}$$

Let $M_L := (D_i D_j)_{i,j=1, \dots, k}$ be the intersection matrix of L , $d(L) := \det(-M_L)$, $\bar{L} := [D_2, \dots, D_k]$ and $\bar{d}(L) := d(\bar{L})$. The rational number

$$e(L) := \frac{\bar{d}(L)}{d(L)}$$

is called the *inductance of L* [Fu 1, (3.5)].

A 5.14. Lemma [Fu 1, (6.16)]. $(Bk(L))^2 = -e(L)$.

A 5.15. Lemma. 1) If $L = \gamma'_{a,b}$, where a and b are relatively prime natural numbers, then $d(L) = a$ and $\bar{d}(L) = b'$, where $0 < b' < a$ and $bb' \equiv -1 \pmod{a}$, and so $e(L) := \frac{b'}{a}$.

2)

$$e\left(\gamma'_{a,b}\right) + e\left(\gamma''_{a,b}\right) = 1 - \frac{1}{ab}$$

Proof. First we shall show that 2) is an easy consequence of 1). Indeed, in view of 1), 2) is equivalent to the equality

$$\frac{a'}{b} + \frac{b'}{a} = 1 - \frac{1}{ab}, \text{ or } aa' + bb' = ab - 1.$$

Let $t := ab - aa' - bb'$. Then $t \equiv 1 \pmod{a}$ and $t \equiv 1 \pmod{b}$ by the definition of a' , b' , and hence $t \equiv 1 \pmod{ab}$ since a and b are relatively prime. Thus, $t = abs + 1$, where $s \in \mathbb{Z}$, $s \leq 0$. If $s \leq -1$, then $t \leq 1 - ab$ or $2ab \leq aa' + bb'$. This contradicts to the inequalities $aa' \leq ab$ and $bb' \leq ab$. Therefore $s = 0$, i.e. $t = 1$ and 2) follows.

The proof of 1) consists of two steps. First of all we make the following remarks. One can consider a cutting cycle procedure over a given normal intersection point z_0 of the curves c_0 and c_1 in terms of dual graphs as a sequence of successive blowing ups of wedges of weighted linear graphs, such that at each step the corresponding graph has only one (-1) -vertex. The latter condition means that the next blowing up is always done at one of two wedges of the preceding graph, incidental to its unique (-1) -vertex. In fact, such a sequence can be arbitrary; for example, its starting steps could look like the following:

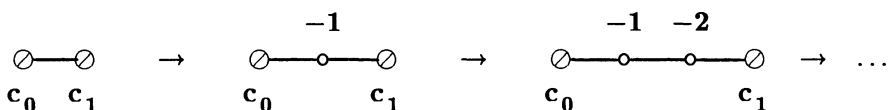

At the same time this sequence is uniquely determined by the rational number $\frac{b}{a}$, where a and b are defined by the conditions $c_0^* = bv + \dots$, $c_1^* = av + \dots$ (here v is the last gluing (-1) -curve), and the resulting graph coincides with the graph $\gamma_{a,b}$ (see A 1.9).

Let $L = \gamma'_{a,b} = [D_1, \dots, D_k]$ and $a_i := -D_i^2$, $a_i \geq 2$, $i = 1, \dots, k$. Denote by $[n_1, n_2, \dots]$, where $n_i \geq 2$, the following continued fraction:

$$[n_1, n_2, \dots] := \frac{1}{n_1 - \frac{1}{n_2 - \dots}} \in (0; 1) .$$

Claim. $[a_1, a_2, \dots, a_k] = \frac{b'}{a}$.

The proof of the claim will be done by induction on the number n of blowing ups, i.e. the number of vertexes of the graph $\gamma_{a,b}$. For $n = 2$ the claim is evidently true. Let $n > 2$. Assume first that $a_1 > 2$. Then $\gamma_{a,b}$ is the result of blowing up of the graph

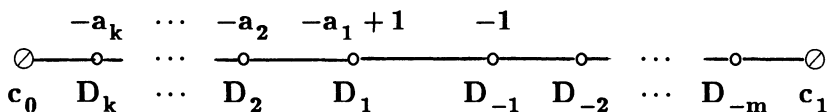

at the wedge $[D_1, D_{-1}]$. Assume that before the last blowing up one has the following expansions:

$$c_0^* = \sum_{i=-m}^k p_i D_i \quad \text{and} \quad c_1^* = \sum_{i=-m}^k q_i D_i \quad .$$

By the inductive hypothesis we have:

$$[a_1 - 1, a_2, \dots, a_k] = \frac{p_{-1}'}{q_{-1}} \quad \text{and} \quad [a_2, \dots, a_k] = \frac{p_1'}{q_1} \quad .$$

For the multiplicities \mathbf{b} , \mathbf{a} of the (-1) -vertex $D_0 := v$ of the graph $\gamma_{\mathbf{a}, \mathbf{b}}$ in the divisors c_0^* , c_1^* respectively we have: $\mathbf{b} = \mathbf{p}_{-1} + \mathbf{p}_1$ and $\mathbf{a} = \mathbf{q}_{-1} + \mathbf{q}_1$. Set

$$\frac{p_0'}{q_0} := [a_1, a_2, \dots, a_k] \quad ,$$

where $(p_0, q_0) = 1$. To complete the induction we must show that $\mathbf{a} = \mathbf{q}_0$ and $\mathbf{b} = \mathbf{p}_0$, or equivalently, that $\mathbf{p}_0 = \mathbf{p}_{-1} + \mathbf{p}_1$ and $\mathbf{q}_0 = \mathbf{q}_{-1} + \mathbf{q}_1$.

From the definitions of the above continued fractions it follows that

$$\frac{q_0'}{p_0'} = a_1 - \frac{p_1'}{q_1} = \frac{q_{-1}'}{p_{-1}'} + 1$$

and therefore

$$p_{-1}' = q_1 = p_0' \quad , \quad q_{-1}' = q_0 = p_0' \quad , \quad p_1' = a_1 p_0' - q_0' \quad .$$

Hence the equality $\mathbf{q}_0 = \mathbf{q}_{-1} + \mathbf{q}_1$ holds.

Rewrite the congruencies $p_i p_i' \equiv -1 \pmod{q_i}$, $i = -1, 0, 1$ in the form:

$$x_i p_i' = y_i q_i - 1 \quad , \quad 0 < x_i < q_i \quad , \quad 0 < y_i < p_i' \quad , \quad i = 0, 1, -1. \quad (*)$$

Using the equalities above, the last two equations can be rewritten in the following form:

$$(i = 1) \quad x_1 (a_1 p_0' - q_0') = y_1 p_0' - 1 \quad ,$$

$$(i = -1) \quad x_{-1} p'_0 = y_{-1} (q_0 - p'_0) - 1 \quad .$$

Let (x_0, y_0) be the least natural solution of the first equation. It is easily seen that the pairs

$$(x_1, y_1) := (y_0, a_1 y_0 - x_0) \quad , \quad (x_{-1}, y_{-1}) := (x_0 - y_0, y_0)$$

satisfy respectively the second and third equations. Since $y_0 < p'_0 = q_1 = p'_{-1}$ we have $x_1 < q_1$ and $y_{-1} < p'_{-1}$. It follows that (x_1, y_1) , (x_{-1}, y_{-1}) are the least positive solutions of the above equations, and hence $x_0 = p_0$, $x_1 = y_0 = p_1$ and $x_{-1} = x_0 - y_0 = p_{-1}$. Therefore $p_0 = p_{-1} + p_1$, and we are done.

Consider further the case, when $a_1 = \dots = a_{n-2} = 2$, $a_{n-1} > 2$ and hence $a_{-1} = n$ (see A 1.9). In this case the graph $\gamma_{a,b}$ has the following form:

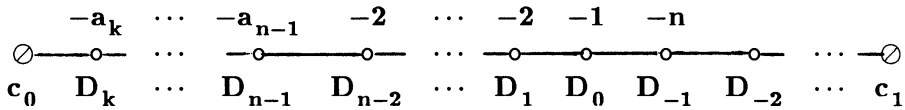

Blowing down successively the vertexes D_0, D_1, \dots, D_{n-2} we get the following graph:

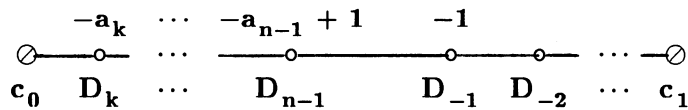

By the inductive hypothesis we have:

$$\frac{p'_{-1}}{q_{-1}} = \left[a_{n-1} - 1, a_n, \dots, a_k \right] \quad , \quad \frac{p'_1}{q_1} = \left[\underbrace{2, \dots, 2}_{n-3}, a_{n-1}, \dots, a_k \right] \quad .$$

Let

$$\frac{p'_0}{q_0} := \left[\underbrace{2, \dots, 2}_{n-2}, a_{n-1}, \dots, a_k \right] \quad .$$

As before, to prove our assertion it is enough to check that $p_0 = p_{-1} + p_1 (=b)$ and $q_0 = q_{-1} + q_1 (=a)$. From the above developments one gets the following equalities:

$$p'_{-1} = (n-1)p'_0 - (n-2)q_0, \quad q_{-1} = q_0 - p'_0,$$

$$p'_1 = 2p'_0 - q_0, \quad q_1 = p'_0.$$

As a consequence, the equality $q_0 = q_{-1} + q_1$ holds. Furthermore, the last two equations of (*) can be rewritten now as follows:

$$(i = 1) \quad (2x_1 - y_1)p'_0 = x_1 q_0 - 1,$$

$$(i = -1) \quad [(n-1)x_{-1} + y_{-1}]p'_0 = [(n-2)x_{-1} + y_{-1}]q_0 - 1.$$

If (x_0, y_0) is the least positive solution of the first equation of (*), then it can be easily checked that the pairs

$$(x_1, y_1) := (y_0, 2y_0 - x_0), \quad (x_{-1}, y_{-1}) := (x_0 - y_0, (n-1)y_0 - (n-2)x_0)$$

satisfy respectively the second and third equations. Hence $x_{-1} + x_1 = x_0$, i.e. $p_{-1} + p_1 = p_0$. **Q.E.D.**

Now we return to the proof of the equality $e(\gamma'_{a,b}) := \frac{b'}{a}$ in 1), or equivalently, of the equalities $d(L) = a$ and $\bar{d}(L) = b'$, where $L = \gamma_{a,b}$ (indeed, $(\bar{d}(L), d(L)) = 1$, see [Fu 1, (3.6)]). By the Euclidean algorithm, from the equality $\frac{b'}{a} = [a_1, a_2, \dots, a_k]$, which just has been proved, one gets:

$$\begin{cases} a = a_1 b' - r_1 \\ b' = a_2 r_1 - r_2 \\ \dots \\ r_{k-2} = a_k r_{k-1} \end{cases}, \quad \text{or} \quad \begin{cases} 1 = a_1 \frac{b'}{a} - \frac{r_1}{a} \\ 0 = -\frac{b'}{a} + a_2 \frac{r_1}{a} - \frac{r_2}{a} \\ \dots \\ 0 = -\frac{r_{k-2}}{a} + a_k \frac{r_{k-1}}{a} \end{cases}$$

Here $r_{k-1} = 1$ and $0 < r_i < r_{i-1}$, $i = 1, \dots, k-1$. Rewrite this system as the equation $A\bar{x} = \bar{e}$, where $A := -M_L$, $\bar{e} := (1, 0, \dots, 0)$ and $x_0 := (\frac{b'}{a}, \frac{r_1}{a}, \dots, \frac{r_{k-1}}{a})$. By Cramer's rule we have: $\frac{b'}{a} = \frac{\bar{d}(L)}{d(L)}$. **Q.E.D.**

Remark. In [Za 1] another proof of Lemma A 5.15 is given.

A 5.16. Theorem (see [Fu 1, (6.20) — (6.24)]) . Let $X = V \setminus D$, where D is a rational tree in a nonsingular projective surface V . Assume that X is affine, $\bar{k}(X) \geq 0$, the dual graph Γ_D has at least two branching points and that there is no -1 -curve E in V , such that $E \not\subset D$, $ED = 1 = EL_0$ for some twig L_0 of D . Then $N := (K + D)^- = \text{Bk}(D)$, where $\text{Bk}(D) := \sum_L \text{Bk}(L)$ and the sum is taken over all twigs of D .

A 5.17. Lemma. Let $X = X_T$ or $X = X_\theta$, where $X_\theta \not\subset \mathbb{C}^2$. Let (V, D) be the minimal SNC-completion of X . Then the assumptions of Theorem A 5.12 are fulfilled and hence $N = \text{Bk}(D)$.

Proof. Since $X \not\subset \mathbb{C}^2$ by the Theorem of Miyanishi — Sugie — Fujita A 5.1, we have that $\bar{k}(X) \geq 0$. By Fujita's Lemma A 1.2, X is affine. In view of Lemmas A 3.2 and A 3.4 it is easily seen that the dual graph Γ_D has at least two branching points.

Assume that for $X = X_T$, $(V, D) = (V_T, D_T)$ there exists a (-1) -curve $E \not\subset D_T$ such that $E \cdot D_T = E \cdot (\text{supp Bk}(D_T)) = 1$. Then $E \cdot (e_0' + e_1') = 0$, — indeed, the branching points e_0' , e_1' of Γ_D do not belong to $\text{supp Bk}(D_T)$. Since the morphism $\pi_T : V_T \rightarrow Q$ (the inverse to the cutting cycles procedure) is an isomorphism in a neighborhood of the curve $e_0' \cup e_1'$ (see A 3.1), we have: $\pi_T(E) \cdot (e_0 + e_1) = 0$. This means that $\pi_T(E)$ is a point in Q and therefore E should coincide with one of the curves v_{ij} , $i, j = 0, 1$. Thus $E \cdot D_T = 2$, — a contradiction.

The proof in the case, when $X = X_\theta$, where $X_\theta \not\subset \mathbb{C}^2$, is based on a more detailed analysis (see [Za 1, (5.1.13)]) and will be omitted here. **Q.E.D.**

A 5.18. Theorem. Let T be an unimodular matrix as in A 3.1, such that $m_{ij} > 1$, $n_{ij} > 1$ for all $i, j = 0, 1$. Then the surface X_T is of hyperbolic type.

Proof. Under our assumptions the graphs $\gamma_{m_{ij}, n_{ij}}'$, $\gamma_{m_{ij}, n_{ij}}''$ ($i, j = 0, 1$) are non-empty and coincide with twigs of the graph Γ_T (see A 3.2). From Lemmas A 5.14, A 5.15 and A 5.17 it follows, that

$$N^2 = (\text{Bk}(D_T))^2 = \sum_{i,j=0,1} \left(\text{Bk} \left(\gamma_{m_{ij}, n_{ij}}' \right) \right)^2 +$$

$$+ \sum_{i,j=0,1} \left(\text{Bk} \left(\gamma \begin{matrix} \text{''} \\ m_{ij}, n_{ij} \end{matrix} \right) \right)^2 = \sum_{i,j=0,1} \frac{1}{m_{ij} n_{ij}} - 4 < -2$$

(indeed, $m_{i,j} n_{i,j} \geq 6$ since $m_{i,j}, n_{i,j}$ are relatively prime and greater than 1).
Now the assertion follows from Corollary A 5.12 . Q.E.D.

More careful analysis leads to the following conclusion.

A 5.19. Theorem ([Za 1, (5.12)] ; [Za2]) .

a) $\bar{k}(X_T) = 1$ iff * either $m_{ii} = n_{ii} = 1$, $i = 0, 1$, or $m_{ij} = n_{ij} = 1$, $i = 0, 1$, $j = 1 - i$. In other cases $\bar{k}(X_T) = 2$.

b) $\bar{k}(X_\theta) \leq 1$ iff $\theta = (1, T)$ and the matrix T has a row, which is equal to $(1, 1)$, $(1, 2)$ or $(2, 1)$.

Theorem A 5.6 follows from Theorem A 5.18, Lemmas A 3.2 , A 3.4 and Remark A 2.5 .

REFERENCES

[Ab Ha Ea] Sh. S. Abhyankar, W. Heinzer, P. Eakin: On the uniqueness of the coefficient ring in a polynomial ring. J. Algebra 23 (1972) , 310–342

[Da] W. Danielewski: On a cancellation problem and automorphism group of affine algebraic varieties. Preprint.

[Fu 1] T Fujita: On the topology of non-complete algebraic surfaces. J. Fac. Sci. Univ. Tokyo (Ser. 1A) 29 (1982), 503–566

[Fu 2] T. Fujita: On Zariski problem. Proc. Japan Acad. (Ser. A) 55 (1979), 106–110

[Gi] M. H. Gizatullin: Invariants of incomplete algebraic surfaces that can be obtained by means of completions (Russian). Izvestiya Akad. Nauk SSSR, Ser. Mat. 35 (1971), 485–497

[Gu 1] R. V. Gurjar: Affine varieties dominated by C^2 . Comment. Math. Helvetici 55 (1980), 378–389

* this condition means that under the cutting cycle procedure $V_T \rightarrow Q$ for one of two pairs of diagonal points, (z_{00}, z_{11}) or (z_{01}, z_{10}) , only one blowing up in each point has been done.

[Gu 2] R. V. Gurjar: Topology of affine varieties dominated by an affine space. *Invent. Math.* 59 (1980), 221–225

[Gu Mi] R. V. Gurjar, M. Miyanishi: Affine surfaces with $\bar{k} \leq 1$. In: *Algebraic Geometry and Commutative Algebra in Honor of Masayoshi Nagata*, 1987, pp. 99–124

[Gu Sha] R. V. Gurjar, A. R. Shastri: On the rationality of complex homology 2–cells. I, II. *J. Math. Soc. Japan* 41–1 (1989), 37–56; 41–2 (1989), 175–212

[Ii 1] Sh. Iitaka: On logarithmic Kodaira dimensions of algebraic varieties. In: *Complex analysis and Algebraic Geometry*. Tokyo: Iwanami 1977, pp. 175–189

[Ii 2] Sh. Iitaka: Some applications of logarithmic Kodaira dimensions. In: *Algebraic Geometry (Proc. Intern. Symp. Kyoto 1978)*, Tokyo: Kinokuniya 1978, pp. 185–206

[Ii Fu] Sh. Iitaka, T Fujita: Cancellation theorem for algebraic varieties. *J. Fac. Sci. Univ. Tokyo (Sec. 1A)* 24 (1977), 123–127

[Ka] Sh. I. Kaliman: Polynomials on \mathbb{C}^2 with isomorphic generic fibers. *Soviet Math. Doklady* 33–1 (1986), 600–603

[Km] T. Kambayashi: On Fujita’s strong cancellation theorem for the affine plane. *J. Fac. Sci. Univ. Tokyo (Sec.1A)* 27 (1980), 535–548

[Kaw] Y. Kawamata: On the classification of non-complete algebraic surfaces. In: *Algebraic Geometry (Proc. Copenhagen Summer Meeting)*. Lecture Notes in Math. 732, Berlin e. a.: Springer-Verlag 1971, pp. 215–232

[Mil] Lectures on the h-cobordism theorem. Princeton: Princeton Univ. Press 1965

[Mi Tsu] M. Miyanishi, S. Tsunoda: Open algebraic surfaces with Kodaira dimension $-\infty$. In: *Proc. Symposia in Pure Math.* 46–1, 1987, pp. 435–450

[Mo] J. A. Morrow: Compactifications of \mathbb{C}^2 . *Bull. AMS* 78 (1972), 813–816

[Ni Suz] T. Nishino, M. Suzuki: Sur les singularites essentielles et isolees des applications holomorphes a valeurs dans une surface complexe. *Publ. RIMS Kyoto Univ.* 16 (1980), 461–497

[Ra] C. P. Ramanujam: A topological characterization of the affine plane as an algebraic variety. *Ann. Math.* 94 (1971), 69–88

[Sa] F. Sakai: Kodaira dimensions of complements of divisors. In: *Complex analysis and Algebraic Geometry*. Tokyo: Iwanami 1977, pp. 238–257

[Su] T. Sugie: On T. Petrie’s problem concerning homology planes. *J. Math. Kyoto Univ.* 30–2 (1990), 317–342

[tDi] T. tom Dieck: Homology planes without cancellation property. Preprint (1990).

[tDi Pe] T. tom Dieck, T. Petrie: Homology planes. An announcement and survey. In: Topological Methods in Algebraic Transformation Groups. Progress in Math. Vol. 80. Boston: Birkhauser 1989, pp. 27–48

[Ts] R. Tsushima: Rational maps to varieties of hyperbolic type. Proc. Japan Acad. (Ser.A) 22 (1979), 95–100

[Ur] T. Urata: Holomorphic automorphisms and cancellation theorems. Nagoya Math. J. 81 (1981), 91–103

[VdV] A. Van de Ven: Analytic compactifications of complex homology cells. Math. Ann. 147 (1962), 189–204

[Za 1] M. G. Zaidenberg: On Ramanujam surfaces, C^{**} -families and exotic algebraic structures on C^n , $n \geq 3$. Trudy Moscow Math. Soc. (to appear)

[Za 2] M. G. Zaidenberg: Ramanujam's surfaces and exotic algebraic structures on C^n , $n \geq 3$. Soviet Math. Doklady; transl. from: Dokl. Akad. Nauk SSSR 314–6 (1990), 1303–1307

[Za 3] M. G. Zaidenberg: Isotrivial families of curves on affine surfaces and characterization of the affine plane. Math. USSR Izvestiya 30–3 (1988), 503–532. Additions and corrections to the paper... *ibid.*, transl. from: Izvestiya AN SSSR 25–1 (1991), 221–223

[Za 4] M. G. Zaidenberg: Rational actions of the group C^* on C^2 , their quasi-invariants, and algebraic curves in C^2 with Euler characteristic 1. Soviet Math. Dokl. 31–1 (1985), 57–60

Mikhail ZAIDENBERG
Université Joseph Fourier (Grenoble I)
Institut Fourier
URA 188 du CNRS
UFR de Mathématiques
B.P.74
38402 ST MARTIN D'HÈRES Cedex
(France)