

B. BONNARD

E. TRÉLAT

On the role of abnormal minimizers in sub-riemannian geometry

Annales de la faculté des sciences de Toulouse 6^e série, tome 10, n° 3 (2001), p. 405-491

http://www.numdam.org/item?id=AFST_2001_6_10_3_405_0

© Université Paul Sabatier, 2001, tous droits réservés.

L'accès aux archives de la revue « Annales de la faculté des sciences de Toulouse » (<http://picard.ups-tlse.fr/~annales/>) implique l'accord avec les conditions générales d'utilisation (<http://www.numdam.org/conditions>). Toute utilisation commerciale ou impression systématique est constitutive d'une infraction pénale. Toute copie ou impression de ce fichier doit contenir la présente mention de copyright.

NUMDAM

Article numérisé dans le cadre du programme
Numérisation de documents anciens mathématiques
<http://www.numdam.org/>

On the role of abnormal minimizers in sub-Riemannian geometry ^(*)

B. BONNARD, E. TRÉLAT ⁽¹⁾

RÉSUMÉ. — On considère un problème sous-Riemannien (U, D, g) où U est un voisinage de 0 dans \mathbb{R}^n , D une distribution lisse de rang 2 et g une métrique lisse sur D . L'objectif de cet article est d'expliquer le rôle des géodésiques anormales minimisantes en géométrie SR. Cette analyse est fondée sur le modèle SR de Martinet.

ABSTRACT. — Consider a sub-Riemannian geometry (U, D, g) where U is a neighborhood at 0 in \mathbb{R}^n , D is a rank-2 smooth (C^∞ or C^ω) distribution and g is a smooth metric on D . The objective of this article is to explain the role of abnormal minimizers in SR-geometry. It is based on the analysis of the Martinet SR-geometry.

1. Introduction

Consider a smooth control system on \mathbb{R}^n :

$$\dot{q}(t) = f(q(t), u(t)) \tag{1}$$

where the set of admissible controls \mathcal{U} is an open set of bounded measurable mappings u defined on $[0, T(u)]$ and taking their values in \mathbb{R}^m . We fix $q(0) = q_0$ and $T(u) = T$ and we consider the *end-point mapping* $E : u \in \mathcal{U} \mapsto q(T, q_0, u)$, where $q(t, q_0, u)$ is the solution of (1) associated to $u \in \mathcal{U}$ and starting from q_0 at $t = 0$. We endow the set of controls defined on $[0, T]$ with the L^∞ -topology. A trajectory $\tilde{q}(t, q_0, \tilde{u})$ denoted in short \tilde{q} is said to be *singular or abnormal* on $[0, T]$ if \tilde{u} is a singular point of the end-point mapping, i.e, the Fréchet derivative of E is not surjective at \tilde{u} .

(*) Reçu le 2 juin 1999, accepté le 9 juillet 2001

(1) Université de Bourgogne, LAAO, B.P. 47870, 21078 Dijon Cedex, France.
e-mail: bbonnard@u-bourgogne.fr, tretlat@topolog.u-bourgogne.fr

Consider now the *optimal control problem* : $\min_{u(\cdot) \in \mathcal{U}} \int_0^T f^0(q(t), u(t)) dt$, where f^0 is smooth and $q(t)$ is a trajectory of (1) subject to boundary conditions : $q(0) \in M_0$ and $q(T) \in M_1$, where M_0 and M_1 are smooth submanifolds of \mathbb{R}^n . According to the *weak maximum principle* [37], minimizing trajectories are among the singular trajectories of the end-point mapping of the *extended system* in \mathbb{R}^{n+1} :

$$\begin{aligned} \dot{q}(t) &= f(q(t), u(t)) \\ \dot{q}^0(t) &= f^0(q(t), u(t)) \end{aligned} \tag{2}$$

and they are solutions of the following equations :

$$\dot{q} = \frac{\partial H_\nu}{\partial p}, \quad \dot{p} = -\frac{\partial H_\nu}{\partial q}, \quad \frac{\partial H_\nu}{\partial u} = 0 \tag{3}$$

where $H_\nu = \langle p, f(q, u) \rangle + \nu f^0(q, u)$ is the *pseudo-Hamiltonian*, p is the adjoint vector, \langle, \rangle the standard inner product in \mathbb{R}^n and ν is a constant which can be normalized to 0 or $-1/2$. Abnormal trajectories correspond to $\nu = 0$; their role in the optimal control problem has to be analyzed. Their geometric interpretation is clear : if \mathcal{C} denotes the set of curves solutions of (1), they correspond to singularities of this set and the analysis of those singularities is a preliminary step in any minimization problem. This problem was already known in the classical calculus of variations, see for instance the discussion in [8] and was a major problem for post-second war development of this discipline whose modern name is optimal control. The main result, concerning the analysis of those singularities in a *generic context* and for *affine systems* where $f(q, u) = F_0(q) + \sum_{i=1}^m u_i F_i(q)$ are given in [12] and [5]. The consequence of this analysis is to get *rigidity* results about singular trajectories when $m = 1$, that is under generic conditions a singular trajectory γ joining $q_0 = \gamma(0)$ to $q_1 = \gamma(T)$ is the only trajectory contained in a C^0 -neighborhood of γ joining q_0 to q_1 in time T (and thus is minimizing).

In optimal control the main concept is the *value function* S defined as follows. If q_0, q_1 and T are fixed and γ is a minimizer associated to u_γ and joining q_0 to q_1 in time T , we set :

$$S(q_0, q_1, T) = \int_0^T f^0(\gamma(t), u_\gamma(t)) dt$$

The value function is solution of Hamilton-Jacobi-Bellman equation and one of the main questions in optimal control is to understand the role of abnormal trajectories on the *singularities* of S .

The objective of this article is to make this analysis in *local sub-Riemannian geometry* associated to the following optimal control problem :

$$\min_{u(\cdot)} \int_0^T \sum_{i=1}^m u_i^2(t) dt, \quad u = (u_1, \dots, u_m)$$

subject to the constraints :

$$\dot{q}(t) = \sum_{i=1}^m u_i(t) F_i(q(t)) \quad (4)$$

$q \in U \subset \mathbb{R}^n$, where $\{F_1, \dots, F_m\}$ are m linearly independent vector fields generating a distribution D and the metric g is defined on D by taking the F_i 's as *orthonormal vector fields*. The *length* of a curve q solution of (4) on $[0, T]$ and associated to $u \in \mathcal{U}$ is given by : $L(q) = \int_0^T \left(\sum u_i^2(t) \right)^{1/2} dt$ and the SR-distance between q_0 and q_1 is the minimum of the length of the curves q joining q_0 to q_1 . The sphere $S(q_0, r)$ with radius r is the set of points at SR-distance r from q_0 . If any pairs q_0, q_1 can be joined by a minimizer, the sphere is made of end-points of minimizers with length r . It is a *level set* of the value function.

It is well known (see [1]) that in SR-geometry the sphere $S(q_0, r)$ with *small* radius r has singularities. For instance they are described in [4] in the generic contact situation in \mathbb{R}^3 and they are semi-analytic. Our aim is to give a *geometric framework* to analyze the *singularities* of the sphere in the abnormal directions and to compute *asymptotics* of the distance in those directions. We analyze mainly the Martinet case extending preliminary calculations from [2, 10]. The calculations are intricate because the singularities are not in the subanalytic category even if the distribution and the metrics are analytic. Moreover they are related to similar computations to *evaluate Poincaré return mappings in the Hilbert's 16th problem* (see [35, 38]) using *singular perturbation techniques*.

The organization and the contribution of this article is the following.

In Sections 2 and 3 we introduce the required concepts and recall some known results from [6, 7, 12] to make this article self-contained.

In Section 2, we compute the singular trajectories for single-input affine control systems : $\dot{q} = F_0(q) + uF_1(q)$, using the Hamiltonian formalism. Then we evaluate under generic conditions the accessibility set near a singular trajectory to get rigidity results and to clarify their optimality status in SR geometry.

In Section 3 we present some generalities concerning SR geometry.

In Section 4 we analyze the role of abnormal geodesics in SR Martinet geometry. We study the behaviour of the geodesics starting from 0 in the abnormal direction by taking their successive intersections with the Martinet surface filled by abnormal trajectories. This defines a *return mapping*. To make precise computations we use a graded form of order 0 where the Martinet distribution is identified to $\text{Ker } \omega$, $\omega = dz - \frac{y^2}{2}dx$, the Martinet surface to $y = 0$, the abnormal geodesic starting from 0 to $t \mapsto (t, 0, 0)$ and the metric is truncated at : $g = (1 + \alpha y)^2 dx^2 + (1 + \beta x + \gamma y)^2 dy^2$, where α, β, γ are real parameters. The geodesics equations project onto the *planar foliation* :

$$\theta'' + \sin \theta + \varepsilon \beta \cos \theta \theta' + \varepsilon^2 \alpha \sin \theta (\alpha \cos \theta - \beta \sin \theta) = 0 \quad (5)$$

where $\varepsilon = \frac{1}{\sqrt{\lambda}}$ is a *small parameter* near the abnormal direction which projects onto the singular points $\theta = k\pi$. Here the Martinet plane $y = 0$ is projected onto a *section* Σ given by :

$$\theta' = \varepsilon(\alpha \cos \theta + \beta \sin \theta) \quad (6)$$

Equation (5) represents a *perturbed pendulum* ; to evaluate the trace of the sphere $S(0, r)$ with the Martinet plane we compute the return mapping associated to the section Σ . Near the abnormal direction the computations are localized to the geodesics projecting near the separatrices of the pendulum.

In order to estimate the asymptotics of the sphere in the abnormal direction we use the techniques developed to compute the asymptotic expansion of the Poincaré return mapping for a one-parameter family of planar vector fields. This allows to estimate the number of limit cycles in the Hilbert's 16th problem, see [38]. Our computations split into two parts :

1. A computation where we estimate the return mapping near a saddle point of the pendulum and which corresponds to geodesics close to the abnormal minimizer *in C^1 -topology*.
2. A global computation where we estimate the return mapping along geodesics visiting the two saddle points and which corresponds to geodesics close to the abnormal minimizer *in C^0 -topology, but not in C^1 -topology* (see [42] for a general statement).

Our results are the following.

- If $\beta = 0$, the pendulum is integrable and we prove that the sphere belongs to the *log-exp category* introduced in [19], and we compute the asymptotics of the sphere in the abnormal direction.
- If $\beta \neq 0$, we compute the asymptotics corresponding to geodesics C^1 close to the abnormal one.

We end this Section by conjecturing the cut-locus in the generic Martinet sphere using the Liu-Sussmann example [29].

The aim of Section 5 is to extend our previous results to the general case and to describe a *Martinet sector* in the n -dimensional SR sphere.

First of all in the Martinet case the exponential mapping *is not proper* and the sphere is *tangent* to the abnormal direction. We prove that this property is still valid if the abnormal minimizer is strict and if the sphere is C^1 -stratifiable.

Then we complete the analysis of SR geometry corresponding to stable 2-dimensional distributions in \mathbb{R}^3 by analyzing the so-called *tangential case*. We compute the geodesics and make some numerical simulations and remarks about the SR spheres.

The flat Martinet case can be lifted into the *Engel case* which is a left-invariant problem of a 4-dimensional Lie group. We give an uniform parametrization of the geodesics using the *Weierstrass function*. Both Heisenberg case and Martinet flat case can be imbedded in the Engel case.

The main contribution of Section 5 is to describe a *Martinet sector* in the SR sphere in any dimension using the computations of Section 4. We use the Hamiltonian formalism (*Lagrangian manifolds*) and *microlocal analysis*. This leads to a *stratification of the Hamilton-Jacobi equation* viewed in the cotangent bundle.

Acknowledgments. — We thank M. Chyba for her numerical simulations concerning the sphere.

2. Singular or abnormal trajectories

2.1. Basic facts

Consider the smooth control system :

$$\dot{q}(t) = f(q(t), u(t)) \tag{7}$$

and let $q(t)$ be a trajectory defined on $[0, T]$ and associated to a control $u \in \mathcal{U}$. If we set :

$$A(t) = \frac{\partial f}{\partial q}(q(t), u(t)) , B(t) = \frac{\partial f}{\partial u}(q(t), u(t))$$

the linear system :

$$\delta \dot{q}(t) = A(t)\delta q(t) + B(t)\delta u(t) \tag{8}$$

is called the *linearized* or *variational* system along (q, u) . It is well known, see [12] that the Fréchet derivative in L^∞ -topology of the end-point mapping E is given by :

$$E'(v) = \Phi(T) \int_0^T \Phi^{-1}(s)B(s)v(s)ds$$

where Φ is the matricial solution of : $\dot{\Phi} = A\Phi$, with $\Phi(0) = \text{id}$.

Hence (q, u) is singular on $[0, T]$ if and only if there exists a non-zero vector \bar{p} orthogonal to $\text{Im } E'(u)$, that is the linear system (8) is *not controllable* on $[0, T]$.

If we introduce the row vector : $p(t) = \bar{p}\Phi(T)\Phi^{-1}(t)$, a standard computation shows that the triple (q, p, u) is solution for almost all $t \in [0, T]$ of the equations :

$$\dot{q} = f(x, u) , \dot{p} = -p \frac{\partial f}{\partial q} , p \frac{\partial f}{\partial u} = 0$$

which takes the Hamiltonian form :

$$\dot{q} = \frac{\partial H}{\partial p} , \dot{p} = -\frac{\partial H}{\partial q} , \frac{\partial H}{\partial u} = 0 \tag{9}$$

where $H(q, p, u) = \langle p, f(q, u) \rangle$. The function H is called the *Hamiltonian* and p is called the *adjoint vector*.

This is the parametrization of the singular trajectories using the maximum principle. We observe that for each $t \in]0, T[$, the restriction of (q, u) is singular on $[0, t]$ and at t the adjoint vector $p(t)$ is orthogonal to the vector space $K(t)$ image of $L^\infty[0, t]$ by the Fréchet derivative of the end-point mapping evaluated on the restriction of u to $[0, t]$. The vector space $K(t)$ corresponds to the *first order Pontryagin's cone* introduced in the proof of the maximum principle. If $t \in]0, T]$ we shall denote by $k(t)$ the codimension of $K(t)$ or in other words the codimension of the singularity. Using the terminology of the calculus of variations $k(t)$ is called the *order of abnormality*.

The parametrization by the maximum principle allows the computation of the singular trajectories. In this article we are concerned by systems of the form :

$$\dot{q}(t) = F_0(q(t)) + u(t)F_1(q(t)) \quad (10)$$

and the algorithm is the following.

2.2. Determination of the singular trajectories

2.2.1. The single input affine case

It is convenient to use Hamiltonian formalism. Given any smooth function H on T^*U , \vec{H} will denote the Hamiltonian vector field defined by H . If H_1, H_2 are two smooth functions, $\{H_1, H_2\}$ will denote their *Poisson bracket* : $\{H_1, H_2\} = dH_1(\vec{H}_2)$. If X is a smooth vector field on U , we set $H = \langle p, X(q) \rangle$ and \vec{H} is the *Hamiltonian lift* of X . If X_1, X_2 are two vector fields with $H_i = \langle p, X_i(q) \rangle, i = 1, 2$ we have : $\{H_1, H_2\} = \langle p, [X_1, X_2](q) \rangle$ where the Lie bracket is : $[X_1, X_2](q) = \frac{\partial X_1}{\partial q}(q)X_2(q) - \frac{\partial X_2}{\partial q}(q)X_1(q)$. We shall denote by $H_0 = \langle p, F_0(q) \rangle$ and $H_1 = \langle p, F_1(q) \rangle$.

If $f(q, u) = F_0(q) + uF_1(q)$, the equation (9) can be rewritten :

$$\dot{q} = \frac{\partial H_0}{\partial p} + u \frac{\partial H_1}{\partial p}, \quad \dot{p} = - \left(\frac{\partial H_0}{\partial q} + u \frac{\partial H_1}{\partial q} \right) \quad \text{a.e.}$$

$$H_1 = 0 \quad \text{for all } t \in [0, T]$$

We denote by $z = (q, p) \in T^*U$ and let (z, u) be a solution of the above equations. Using the chain rule and the constraint : $H_1 = 0$, we get :

$$0 = \frac{d}{dt} H_1(z(t)) = dH_1(z(t))\vec{H}_0(z(t)) + u(t)dH_1(z(t))\vec{H}_1(z(t)) \quad \text{for a.e. } t$$

This implies : $0 = \{H_1, H_0\}(z(t))$ for all t . Using the chain rule again we get :

$$0 = \{\{H_1, H_0\}, H_0\}(z(t)) + u(t)\{\{H_1, H_0\}, H_1\}(z(t)) \quad \text{for a.e. } t$$

This last relation enables us to compute $u(t)$ in many cases and justifies the following definition :

DEFINITION 2.1. — For any singular curve $(z, u) : J = [0, T] \rightarrow T^*U \times \mathbb{R}$, $\mathcal{R}(z, u)$ will denote the set $\{t \in J, \{\{H_0, H_1\}, H_1\}(z(t)) \neq 0\}$. The set $\mathcal{R}(z, u)$ possibly empty is always an open subset of J .

DEFINITION 2.2. — A singular trajectory $(z, u) : J \longrightarrow T^*U \times \mathbb{R}$ is called of order two if $\mathcal{R}(z, u)$ is dense in J .

The following Proposition is straightforward :

PROPOSITION 2.1. — *If $(z, u) : J \longrightarrow T^*M \times \mathbb{R}$ is a singular trajectory and $\mathcal{R}(z, u)$ is not empty then :*

1. z restricted to $\mathcal{R}(z, u)$ is smooth ;
2. $u(t) = \frac{\{\{H_0, H_1\}, H_0\}(z(t))}{\{\{H_1, H_0\}, H_1\}(z(t))}$ for a.e. t
3. $\frac{dz(t)}{dt} = \vec{H}_0(z(t)) + \frac{\{\{H_0, H_1\}, H_0\}(z(t))}{\{\{H_1, H_0\}, H_1\}(z(t))} \vec{H}_1(z(t))$ for all $t \in \mathcal{R}(z, u)$.

Conversely, let (F_0, F_1) be a pair a smooth vector fields such that the open subset Ω of all $z \in T^*U$ such that $\{\{H_0, H_1\}, H_1\}(z) \neq 0$ is not empty. If $H : \Omega \longrightarrow \mathbb{R}$ is the function $H_0 + \frac{\{\{H_0, H_1\}, H_0\}}{\{\{H_1, H_0\}, H_1\}} H_1$ then any trajectory of \vec{H} starting at $t = 0$ from the set $H_1 = \{H_1, H_0\} = 0$ is a singular trajectory of order 2.

This algorithm allows us to compute the singular trajectories of minimal order. More generally we can extend this computation to the general case.

DEFINITION 2.3. — For any multi-index $\alpha \in \{0, 1\}^n$, $\alpha = (\alpha_1, \dots, \alpha_n)$ the function H_α is defined by induction by : $H_\alpha = \{H_{(\alpha_1, \dots, \alpha_{n-1})}, H_{\alpha_n}\}$. A singular trajectory (z, u) is said of order $k \geq 2$ if all the brackets of order $m \leq k : H_\beta$, with $\beta = (\beta_1, \dots, \beta_m)$, $\beta_1 = 1$ are 0 along z and there exists $\alpha = (1, \alpha_2, \dots, \alpha_k)$ such that $H_{\alpha_1}(z)$ is not identically 0.

The generic properties of singular trajectories are described by the following Theorems of [13].

THEOREM 2.2. — *There exists an open dense subset G of pairs of vector fields (F_0, F_1) such that for any couple $(F_0, F_1) \in G$, the associated control system has only singular trajectories of minimal order 2.*

THEOREM 2.3. — *There exists an open dense subset G_1 in G such that for any couple (F_0, F_1) in G_1 , any singular trajectory has an order of abnormality equal to one, that is corresponds to a singularity of the end-point mapping of codimension one.*

2.2.2. The case of rank two distributions

Consider now a distribution D of rank 2. In SR-geometry we need to compute singular trajectories $t \mapsto q(t)$ of the distribution and it is not restrictive to assume the following : $t \mapsto q(t)$ is a smooth immersion. Then locally there exist two vector fields F_1, F_2 such than $D = \text{Span} \{F_1, F_2\}$ and moreover the trajectory can be reparametrized to satisfy the associated affine system :

$$\dot{q}(t) = u_1(t)F_1(q(t)) + u_2(t)F_2(q(t))$$

where $u_1(t) = 1$. It corresponds to the choice of a *projective chart* on the control domain.

Now an important remark is the following. If we introduce the Hamiltonian lifts : $H_i = \langle p, F_i(q) \rangle$ for $i = 1, 2$, and $H = \sum_{i=1}^2 u_i H_i$ the singular trajectories are solutions of the equations :

$$\dot{p} = \frac{\partial H}{\partial q}, \quad \dot{q} = -\frac{\partial H}{\partial p}, \quad \frac{\partial H}{\partial u} = 0$$

Here the constraints $\frac{\partial H}{\partial u} = 0$ means : $H_1 = 0$ and $H_2 = 0$. This leads to the following definition :

DEFINITION 2.4. — Consider the affine control system : $\dot{q} = F_1 + uF_2$. A singular trajectory is said exceptional if it is contained on the level set : $H = 0$, where $H = \langle p, F_1 \rangle + u \langle p, F_2 \rangle$ is the Hamiltonian.

Hence to compute the singular trajectories associated to a distribution we can apply locally the algorithm described in the affine case and keeping only the exceptional trajectories. An instant of reflexion shows that those of minimal order form a subset of *codimension one* in the set of all singular trajectories because H is constant along such a trajectory and the additional constraint $H_1 = 0$ has to be satisfied only at time $t = 0$. Hence we have :

PROPOSITION 2.4. — *The singular arcs of D are generically singular arcs of order 2 of the associated affine system. They are exceptional and form a subset of codimension one in the set of all singular trajectories.*

2.3. Feedback equivalence

DEFINITION 2.5. — Consider the class \mathcal{S} of smooth control systems of the form :

$$\dot{q}(t) = f(q(t), u(t)), \quad q \in \mathbb{R}^n, \quad u \in \mathbb{R}^m$$

Two systems $f(x, u)$ and $f'(y, v)$ are called feedback equivalent if there exists a smooth diffeomorphism of the form : $\Phi : (x, u) \mapsto (y, v)$, $y = \varphi(x)$, $v = \psi(x, u)$ which transforms f into f' :

$$d\Phi(x)f(x, u) = f'(y, v)$$

and we use the notation $f' = \Phi * f$.

Here we gave a global definition but there are local associated concepts which are :

- local feedback equivalence at a point $(x_0, u_0) \in \mathbb{R}^n \times \mathbb{R}^m$.
- local feedback equivalence at a point x_0 of the state-space.
- local feedback equivalence along a given trajectory : $q(t)$ or $(q(t), u(t))$ of the system.

This induces a group transformation structure called the feedback group G_f on the set of such diffeomorphisms. For affine systems we consider a subgroup of G_f which stabilizes the class. This leads to the following definition.

DEFINITION 2.6. — Consider the class of m -inputs affine control systems :

$$\frac{dq}{dt}(t) = F_0(q(t)) + F(q(t))u(t)$$

where $F(q)u = \sum_{i=1}^m u_i F_i(q)$. It is identified to the set $\mathcal{A}_{m+1} = \{F_0, F_1, \dots, F_m\}$

of $(m+1)$ -uplets of vector fields. The vector field F_0 is called the drift. Let D be the distribution defined by $D = \text{Span} \{F_1(q), \dots, F_m(q)\}$. We restrict the feedback transformations to diffeomorphisms of the form $\Phi = (\varphi(q), \psi(q, u) = \alpha(q) + \beta(q)u)$, preserving the class \mathcal{A} . We denote by G the set of triples (φ, α, β) endowed with the group structure induced by G_f .

We observe the following : take $(F_0, F) \in \mathcal{A}$ and $\Phi = (\varphi, \alpha, \beta) \in G$, then the image of (F_0, F) by Φ is the affine system (F'_0, F') given by :

$$(i) \quad F'_0 = \varphi * (F_0 + F.\beta)$$

$$(ii) \quad F' = \varphi * F.\beta.$$

In particular the second action corresponds to the equivalence of the two distributions D and D' associated to the respective systems.

The proof of the following result is straightforward, see [9].

PROPOSITION 2.5. — *The singular trajectories are feedback invariants.*

Less trivial is the assertion that for generic systems, singular trajectories will allow to compute a *complete* set of invariants, see [9] for such a discussion.

2.4. Local classification of rank 2 generic distributions D in \mathbb{R}^3

We recall the generic classification of rank 2 distributions in \mathbb{R}^3 , see [45], with its interpretation using singular trajectories. Hence we consider a system :

$$\dot{q}(t) = u_1(t)F_1(q(t)) + u_2(t)F_2(q(t))$$

$q = (x, y, z)$. We set $D = \text{Span} \{F_1, F_2\}$ and we assume that D is of rank 2. Our classification is localized near a point $q_0 \in \mathbb{R}^3$ and we can assume $q_0 = 0$. We deal only with generic situations, that is all the cases of codimension ≤ 3 . We have three situations which can be distinguished using the singular trajectories.

Introducing $H_i = \langle p, F_i(q) \rangle, i = 1, 2$, a singular trajectory $z = (q, p)$ must satisfy :

$$H_1 = H_2 = \{H_1, H_2\} = 0$$

and hence they are contained in the set $M : \{q \in \mathbb{R}^3 ; \det (F_1, F_2, [F_1, F_2]) = 0\}$ called the *Martinet surface*. The singular controls of order 2 satisfy :

$$u_1\{\{H_1, H_2\}, H_1\} + u_2\{\{H_1, H_2\}, H_2\} = 0$$

We define the singular set $S = S_1 \cap S_2$ where $S_i = \{\det(F_1, F_2, [[F_1, F_2], F_i]) = 0\}$. We have the following situations.

Case 1. — Take a point $q_0 \notin M$, then through q_0 there passes no singular arc. In this case D is (C^∞ or C^ω)-isomorphic to $\text{Ker } \alpha$, with $\alpha = ydx + dz$. For this normalization $d\alpha = dy \wedge dx$ (Darboux) and $\frac{\partial}{\partial z}$ is the characteristic direction. This case is called the *contact case*.

Case 2 (Codimension one). — We take a point $q_0 \in M \setminus S$. Since $q_0 \notin S$, we observe that M is near q_0 a smooth surface. This surface is foliated by the singular trajectories. A smooth (C^∞ or C^ω)-normal form is given by $D = \text{Ker } \alpha$, where $\alpha = dz - \frac{y^2}{2}dx$. In this normal form we have the following identification :

- Martinet surface $M : y = 0$.

- The singular trajectories are the solution of $Z = \frac{\partial}{\partial x}$ restricted to $y = 0$.

This case is called the *Martinet case*.

Case 3 (Codimension 3). — We take a point $x_0 \in M \cap S$ and we assume that the point q_0 is a regular point of M . The analysis of [45] shows that in this case we have two different C^∞ -reductions to a C^ω -normal form depending both upon a *modulus* m . The two cases are :

1. **Hyperbolic case.** $D = \text{Ker } \alpha$, $\alpha = dy + (xy + x^2z + mx^3z^2)dz$. In this representation the Martinet surface is given by :

$$y + 2xz + 3mx^2z^2 = 0$$

and the singular flow in M is represented in the (x, z) coordinates by :

$$\begin{aligned} \dot{x} &= 2x + (6m - 1)x^2z - 2mx^3z^2 \\ \dot{z} &= -(2z + 6mxz^2) \end{aligned}$$

We observe that 0 is a *resonant saddle* and the parameter m is an *obstruction to the C^∞ -linearization*.

2. **Elliptic case.** $D = \text{Ker } \alpha$, $\alpha = dy + (xy + \frac{x^3}{3} + xz^2 + mx^3z^2)dz$. The Martinet surface is here identified to :

$$y + x^2 + z^2 + 3mx^2z^2 = 0$$

in which the singular flow is given by :

$$\begin{aligned} \dot{x} &= 2z - \frac{2x^3}{3} + 6mx^2z - 2mx^3z^2 \\ \dot{z} &= -(2x + 6mxz^2) \end{aligned}$$

Hence 0 is a center and still m is an obstruction to C^∞ -linearization. The analysis of [44] shows that the singularity is C^0 -equivalent to a focus.

We call the case 3 the *tangential situation* because D is tangent to the Martinet surface at 0. We must stress that it is not a *simple singularity* and moreover there are *numerous analytic moduli*.

2.5. Accessibility set near a singular trajectory

The objective of this Section is to recall briefly the results of [12] *which describe geometrically the accessibility set near a given singular trajectory satisfying generic assumptions* (see also [42, 41]).

2.5.1. Basic assumptions and definitions

We consider a smooth single input smooth affine control system :

$$\dot{q}(t) = F_0(q(t)) + u(t)F_1(q(t)), \quad q \in U.$$

Let γ be a reference singular trajectory corresponding to a control $u \in L^\infty[0, T]$ and starting at $t = 0$ from $\gamma(0) = q_0$ and we denote by (γ, p, u) , where p is an adjoint vector for the associated solution of the equations (9) from the maximum principle. We assume the following :

- (H0) (γ, p) is contained in the set $\Omega = \{z = (q, p) ; \{\{H_0, H_1\}, H_1\}(z) \neq 0\}$, γ is contained in the set $\Omega' = \{q ; X(q) \text{ and } Y(q) \text{ are linearly independant}\}$ and moreover $\gamma : [0, T] \longrightarrow U$ is one-to-one.

Then according to the results of Section 2.2, the curve $z = (\gamma, p)$ is a singular curve of order 2 solution of the Hamiltonian vector field \vec{H} , with $H = H_0 + \frac{\{\{H_0, H_1\}, H_0\}}{\{\{H_1, H_0\}, H_1\}} H_1$. Moreover the trajectory $\gamma : [0, T] \longrightarrow \Omega'$ is a smooth curve and γ is a one-to-one immersion.

Using the feedback invariance of the singular trajectories we may assume the following normalizations : $u(t) = 0$ for $t \in [0, T]$ and γ can be taken as the trajectory : $t \rightarrow (t, 0, 0, \dots, 0)$. Since u is normalized to 0, by successive derivations of the constraints $H_1 = 0$, i.e $\langle p(t), F_1(\gamma(t)) \rangle = 0$ for $t \in [0, T]$, we get the relations :

$$\langle p(t), V^k(\gamma(t)) \rangle = 0, \quad k = 0, \dots, +\infty$$

where V^k is the vector field $\text{ad}^k F_0(F_1)$ and ad^k is defined recursively by :

$$\text{ad}^0 F_0(F_1) = F_1, \quad \text{ad}^k F_0(F_1) = [F_0, \text{ad}^{k-1} F_0(F_1)]$$

It is well known, see [21], [23], that for $t > 0$ the space $E(t) = \text{Span} \{V^k(\gamma(t)), k \in \mathbb{N}\}$ is contained in the first order Pontryagin's cone $K(t)$ evaluated along γ . We make the following assumptions :

- (H1) For $t \in [0, t]$, the vector space $E(t)$ is of codimension one and generated by $\{V^0(\gamma(t)), \dots, V^{(n-2)}(\gamma(t))\}$.
- (H2) If $n \geq 3$, for each $t \in [0, T]$, $X(\gamma(t)) \notin \text{Span} \{V^0(\gamma(t)), \dots, V^{(n-3)}(\gamma(t))\}$

DEFINITION 2.7. — Let $(\gamma(t), p(t), u(t))$ be the reference trajectory defined on $[0, T]$ and assume that the previous assumptions (H0), (H1), (H2)

are satisfied. According to (H1) the adjoint vector p is unique up to a scalar. The Hamiltonian is $H = H_0 + uH_1$ along the reference trajectory and $H_1 = 0$. If $H = 0$, we say that γ is G -exceptional. Let $D = \frac{\partial}{\partial u} \frac{d^2}{dt^2} \frac{\partial H}{\partial u} = \langle p(t), [[F_1, F_0], F_1](\gamma(t)) \rangle$. The trajectory γ is said G -hyperbolic if $H.D > 0$ along γ and G -elliptic if $H.D < 0$ along γ .

Remark 2.1. — According to the *higher-order maximum principle* the condition $H.D|_\gamma \geq 0$ called the Legendre-Clebsch condition is a time optimality necessary condition, see [23].

2.5.2. Semi-normal forms

The main tool to evaluate the end-point mapping is to construct semi-normal forms along the reference trajectory γ using the assumptions (H0, H1, H2) and the action of the feedback group localized near γ . They are given in [12] and we must distinguish two cases.

PROPOSITION 2.6. — *Assume that γ is a G -hyperbolic or elliptic trajectory. Then the system is feedback equivalent in a C^0 -neighborhood of γ to a system (N_0, N_1) with :*

$$N_0 = \frac{\partial}{\partial q^1} + \sum_{i=2}^{n-1} q^{i+1} \frac{\partial}{\partial q^i} + \sum_{i,j=2}^n a_{ij}(q^1) q^i q^j \frac{\partial}{\partial x^1} + R, \quad N_1 = \frac{\partial}{\partial q^n}$$

where $a_{n,n}$ is strictly positive (resp. negative) on $[0, T]$ if γ is elliptic (resp. hyperbolic) and $R = \sum_{i=1}^{n-1} R_i \frac{\partial}{\partial q^i}$ is a vector field such that the weight of R_i has order greater or equal to 2 (resp. 3) for $i = 2, \dots, n-1$ (resp. $i = 1$), the weights of the variables q^i being 0 for $i = 1$, and 1 for $i = 2, \dots, n$.

Geometric interpretation :

- The reference trajectory γ is identified to $t \mapsto (t, 0, \dots, 0)$ and the associated control is $u \equiv 0$. In particular $N_{0|_\gamma} = \frac{\partial}{\partial q^1|_\gamma}$.
- We have :
 - (i) $N_1 = \frac{\partial}{\partial q^n}$
 - (ii) $ad^k N_0.N_1|_\gamma = \begin{cases} \frac{\partial}{\partial q^{n-k}} & \text{if } k = 1, \dots, n-2 \\ 0 & \text{if } k > n-2 \end{cases}$

On the role of abnormal minimizers in sub-Riemannian geometry

$$(iii) \text{ ad}^2 N_1 . N_0 = \frac{\partial^2 N_1}{\partial q^{n^2}}$$

and the first order Pongryagin's cone along γ is : $K|_\gamma = \left\{ \frac{\partial}{\partial q^2|_\gamma}, \dots, \frac{\partial}{\partial q^n|_\gamma} \right\}$.

The linearized system is autonomous and in the Brunovsky canonical form : $\dot{\varphi}^1 = \varphi^2, \dots, \dot{\varphi}^n = u$.

- The adjoint vector associated to γ is $p = (\varepsilon, 0, \dots, 0)$ where $\varepsilon = +1$ in the elliptic case and $\varepsilon = -1$ in the hyperbolic case, the Hamiltonian being ε .
- The *intrinsic second-order derivative* of the end-point mapping is identified along γ to :

$$\varepsilon \int_0^T \sum_{i,j=2}^n a_{ij}(t) \varphi^i(t) \varphi^j(t) dt$$

with $\dot{\varphi}^2 = \varphi^3, \dots, \dot{\varphi}^{n-1} = \varphi^n, \dot{\varphi}^n = u$ and the boundary conditions at $s = 0$ and T : $\varphi^2(s) = \dots = \varphi^n(s) = 0$.

PROPOSITION 2.7. — *Let γ be a G-exceptional trajectory. Then $n \geq 3$ and there exists a C^0 -neighborhood of γ in which the system is feedback equivalent to a system (N_0, N_1) with :*

$$N_0 = \frac{\partial}{\partial q^1} + \sum_{i=1}^{n-2} q^{i+1} \frac{\partial}{\partial q^i} + \sum_{i,j=2}^{n-1} a_{ij}(q^1) q^i q^j \frac{\partial}{\partial q^n} + R$$

$$N_1 = \frac{\partial}{\partial q^{n-1}}$$

where $a_{n-1,n-1}$ is strictly positive on $[0, T]$ and $R = \sum_{i=1}^n R_i \frac{\partial}{\partial q^i}$, $R_{n-1} = 0$ is a vector field such that the weight of R_i has order greater or equal to 2 (resp. 3) for $i = 1, \dots, n-2$ (resp. $i = n$), the weights of the variables q^i being zero for $i = 1$, one for $i = 2, \dots, n-1$ and two for q^n .

Geometric interpretation

- The reference trajectory γ is identified to $t \mapsto (t, 0, \dots, 0)$ and the associated control is $u \equiv 0$.
- We have the following normalizations :

$$(i) \text{ ad}^k N_0 . N_1|_\gamma = \begin{cases} \frac{\partial}{\partial q^{n-1-k}} & \text{for } k = 0, \dots, n-3 \\ 0 & \text{for } k > n-2 \end{cases}$$

$$(ii) \quad N_{0|\gamma} = ad^{n-2} N_0.N_{1|\gamma} = \frac{\partial}{\partial q_{|\gamma}^1}.$$

$$(iii) \quad ad^2 N_1.N_0 = \frac{\partial^2 N_1}{\partial q^{n-1^2}}$$

and the first order Pontryagin's cone along γ is

$$K_{|\gamma} = Span \left\{ \frac{\partial}{\partial q_{|\gamma}^1}, \dots, \frac{\partial}{\partial q_{|\gamma}^{n-1}} \right\}.$$

In the exceptional case $\dot{\gamma}(t)$ is tangent to $K_{|\gamma(t)}$.

The linearized system along γ is the system : $\dot{\varphi}^1 = \varphi^2, \dots, \dot{\varphi}^{n-2} = \varphi^{n-1}, \dot{\varphi}^{n-1} = u.$

- The adjoint vector p associated to γ can be normalized to $p = (0, \dots, 0, -1).$
- The intrinsic second-order derivative of the end-point mapping along γ is identified to :

$$- \int_0^T \sum_{i,j=2}^{n-1} a_{ij}(t) \varphi^i(t) \varphi^j(t) dt$$

with : $\dot{\varphi}^1 = \varphi^2, \dots, \dot{\varphi}^{n-2} = \varphi^{n-1}, \dot{\varphi}^n = u$ and the boundary conditions at $s = 0$ and T : $\varphi^1(s) = \dots = \varphi^{n-1}(s) = 0.$

2.5.3. Evaluation of the accessibility set near γ

We consider all trajectories $q(t, u)$ of the system starting at time $t = 0$ from $\gamma(0) = 0$; the *accessibility set* at time t is the set : $A(0, t) = \bigcup_{u \in \mathcal{U}} q(t, u).$ It is the image of the end-point mapping.

We use our semi-normal forms to evaluate the accessibility set for all trajectories of the system contained in a C^0 -neighborhood of γ . We have the following, see [12] for the details.

Hyperbolic-elliptic situation

By truncating the semi-normal form and replacing q^1 by t we get a *linear-quadratic model* :

$$\begin{aligned} \dot{q}^1 &= 1 + \sum_{i,j=2}^n a_{ij}(t) q^i q^j \\ \dot{q}^2 &= q^3, \dots, \dot{q}^n = u \end{aligned}$$

and it can be *integrated in cascade*.

Let $0 < t \leq T$ and fix the following boundary conditions : $q(0) = 0$ and : $q^2(t) = \dots = q^{n-1}(t) = q^n(t) = 0$, we get a projection of the accessibility set $A(0, t)$ in the line q^1 which describes the singularity of the end-point mapping evaluated on $u(s) = 0$ for $0 \leq s \leq t$. Fig. 1 represents this projection when t varies.

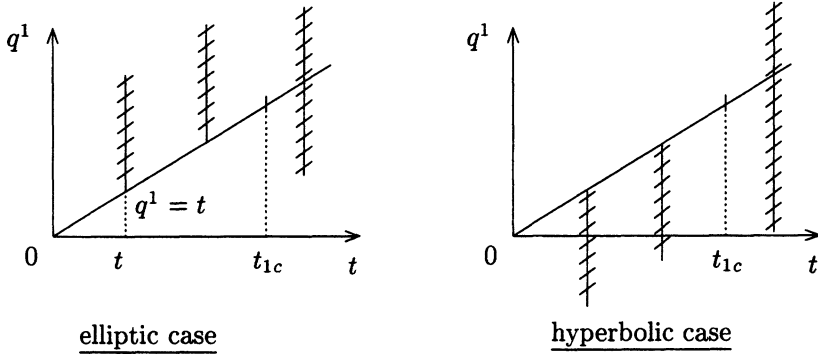

Figure 1

Geometric interpretation The reference trajectory γ is C^0 -time minimal (resp. time maximal) in the hyperbolic case (resp. elliptic case) up to a time t_{1c} which corresponds to a *first conjugate time* $t_{1c} > 0$ along γ for the time minimal (resp. time maximal) control problem.

In particular we get the following Proposition :

PROPOSITION 2.8. — *Assume $T < t_{1c}$. Then the reference singular trajectory γ defined on $[0, T]$ is in the hyperbolic (resp. elliptic) case the only trajectory $\bar{\gamma}$ contained in a C^0 -neighborhood of γ and satisfying the boundary conditions : $\bar{\gamma}(0) = \gamma(0)$, $\bar{\gamma}(\bar{T}) = \gamma(T)$ in a time $\bar{T} \leq T$ (resp. $\bar{T} \geq T$).*

This property is called C^0 -one-side rigidity, compare with [5].

Exceptional case

We proceed as before. The model is :

$$\begin{aligned} \dot{q}^1 &= 1 + q^2, \quad \dot{q}^2 = q^3, \quad \dots, \quad \dot{q}^{n-1} = u \\ \dot{q}^n &= \sum_{i,j=2}^{n-1} a_{ij}(t) q^i q^j \end{aligned}$$

Let $0 < t, t' \leq T$ and consider the following boundary conditions :

$q(0) = 0$ and $q^1(t') = t, q^2(t') = \dots = q^{n-1}(t') = 0$. We get a projection of the accessibility set $A(0, t')$ on the line q^n . It is represented on Fig. 2.

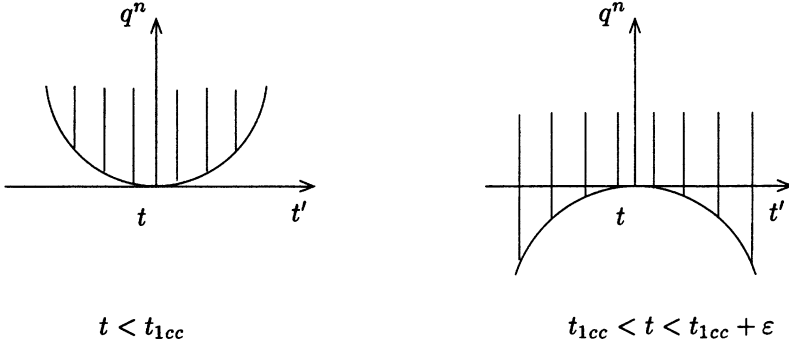

Figure 2

Geometric interpretation The reference trajectory γ is C^0 -time optimal up to a time t_{1cc} which corresponds to a first conjugate time $t_{1cc} > 0$. In particular we have the following result.

PROPOSITION 2.9. — *Assume $T < t_{1cc}$. Then the reference singular exceptional trajectory γ is C^0 -isolated (or C^0 -rigid).*

2.5.4. Conclusion : the importance of singular trajectories in optimal control

The previous analysis shows that singular trajectories play generically an important role in any optimal control problem : $\text{Min} \int_0^T f^0(x, u) dt$ when the transfert time T is fixed. Indeed they are locally *the only trajectories satisfying the boundary conditions* and hence are optimal. If the transfert time T is not fixed only exceptional singular trajectories play a role. In fact as observed by [5] they correspond to the singularities of the *time extended end-point mapping* : $\bar{E} : (T, u) \mapsto q(T, x_0, u)$. It is the situation encountered in sub-Riemannian geometry.

3. Generalities about sub-Riemannian geometry

From now on, we work in the C^ω -category.

DEFINITION 3.1. — A SR-manifold is defined as a n -dimensional manifold M together with a distribution D of constant rank $m \leq n$ and a

Riemannian metric g on D . An admissible curve $t \mapsto q(t)$, $0 \leq t \leq T$ is an absolutely continuous curve such that $\dot{q}(t) \in D(q(t)) \setminus \{0\}$ for almost every t . The length and the energy of q are respectively defined by :

$$L(q) = \int_0^T (\dot{q}(t), \dot{q}(t))^{1/2} dt, \quad E(q) = \int_0^T (\dot{q}(t), \dot{q}(t)) dt$$

where (\cdot, \cdot) is the scalar product defined by g on D . The SR-distance between $q_0, q_1 \in M$ denoted $d_{SR}(q_0, q_1)$ is the infimum of the lengths of the admissible curves joining q_0 to q_1 .

3.1. Optimal control formulation

The problem can be *locally* restated as follows. Let $q_0 \in M$ and choose a coordinate system (U, q) centered at q_0 such that there exist m (smooth) vector fields $\{F_1, \dots, F_m\}$ which form an orthonormal basis of D . Then each admissible curve $t \rightarrow q(t)$ on U is solution of the control system :

$$\dot{q}(t) = \sum_{i=1}^m u_i(t) F_i(q(t)) \tag{11}$$

The length of a curve does not depend on its parametrization, hence every admissible curve can be reparametrized into a lipschitzian curve $s \mapsto q(s)$ parametrized by arc-length : $(\dot{q}(s), \dot{q}(s)) = 1$, see [29].

If an admissible curve on $U : t \mapsto q(t)$, $0 \leq t \leq T$ is parametrized by arc-length we have almost everywhere :

$$\dot{q}(t) = \sum_{i=1}^m u_i F_i(q(t)), \quad \sum_{i=1}^m u_i^2(t) = 1$$

and $L(q) = \int_0^T (\sum_{i=1}^m u_i^2)^{1/2} dt = T$. Hence the length minimization problem is equivalent to a *time-optimal problem* for system (11). This problem is not convex because of the constraints : $\sum_{i=1}^m u_i^2 = 1$, but it is well-known that the problem is equivalent to a time optimal control problem with the convex constraints : $\sum_{i=1}^m u_i^2(t) \leq 1$.

It is also well-known that if every curve is parametrized on a *fixed* interval $[0, T]$, the length minimization problem is equivalent to the energy minimization problem.

Introducing the extended control system :

$$\begin{aligned}\dot{q}(t) &= \sum_{i=1}^m u_i(t) F_i(q(t)) \\ \dot{q}^0(t) &= \sum_{i=1}^m u_i^2(t), \quad q^0(0) = 0\end{aligned}\tag{12}$$

and the end-point mapping \tilde{E} of the extended system : $u \in \mathcal{U} \mapsto \tilde{q}(t, u, \tilde{q}_0)$, $\tilde{q} = (q, q^0)$, $\tilde{q}(0) = (q_0, 0)$, from the maximum principle the minimizers can be selected among the solutions of the maximum principle :

$$\dot{\tilde{q}}(t) = \frac{\partial \tilde{H}}{\partial p}, \quad \dot{\tilde{p}}(t) = -\frac{\partial \tilde{H}}{\partial \tilde{q}}, \quad \frac{\partial \tilde{H}}{\partial u} = 0$$

where $\tilde{H} = \langle p, \sum_{i=1}^m u_i F_i(q) \rangle + p_0 \sum_{i=1}^m u_i^2$ is the pseudo-Hamiltonian and $\tilde{p} = (p, p_0) \in \mathbb{R}^{n+1} \setminus \{0\}$ is the adjoint vector of the extended system. From the previous equation $t \mapsto p_0(t)$ is a constant which can be normalized to 0 or $-1/2$. Introduce $H_\nu = \langle p, \sum_{i=1}^m u_i F_i(q) \rangle + \nu \sum_{i=1}^m u_i^2$ where $\nu = 0$ or $-1/2$; then the previous equations are equivalent to :

$$\dot{q} = \frac{\partial H_\nu}{\partial p}, \quad \dot{p} = -\frac{\partial H_\nu}{\partial q}, \quad \frac{\partial H_\nu}{\partial u} = 0.\tag{13}$$

The solutions of these equations correspond to the singularities of the end-point mapping of the extended system and are called *geodesics* in the framework of SR-geometry.

They split into two categories according to the following definition.

DEFINITION 3.2. — A geodesic is said to be *abnormal* if $\nu = 0$, and *normal* if $\nu = -1/2$. Abnormal geodesics are precisely the singular trajectories of the original system (11).

A geodesic is called *strict* if the extended adjoint vector $(p, p_0 = \nu)$ is unique up to a scalar, that is corresponds to a *singularity of codimension one* of the extended end-point mapping.

3.2. Computations of the geodesics

3.2.1. Abnormal case

They correspond to $\nu = 0$, and are the singular trajectories of system (11). The system is symmetric and hence $H = \sum_{i=1}^m u_i P_i$, with $P_i = \langle p, F_i(q) \rangle$. Therefore they are *exceptional*. When $m = 2$, they are computed using the algorithm of Section 2. The case $m > 2$ will be excluded in our forthcoming analysis because from [5] in order to be optimal a singular trajectory must satisfy the following conditions, known as Goh's conditions :

$$\langle p(t), [Fv, Fw](q(t)) \rangle = 0 \quad (14)$$

$\forall v, w \in \mathbb{R}^m, \forall t \in [0, T]$ and Fu denotes $\sum u_i F_i$. If $m = 2$, this reduces to the condition $\{P_1, P_2\} = 0$ deduced from the conditions $P_1 = P_2 = 0$ but if $m > 2$ it is a very restrictive condition which should not be generic (conjecture [21]).

3.2.2. Normal case

They correspond to $\nu = -1/2$. If the system of the F_i 's is orthonormal then $\frac{\partial H_\nu}{\partial u} = 0$ and hence $u_i = P_i$ and H_ν reduces to $H_n = \frac{1}{2} \sum_{i=1}^m P_i^2$. The trajectories parametrized by arc length are on the level set $H_n = 1/2$ and the normal geodesics are solutions of the following *Hamiltonian differential equations* :

$$\dot{q} = \frac{\partial H_n}{\partial p}, \quad \dot{p} = -\frac{\partial H_n}{\partial q} \quad (15)$$

On the domain chart U , we can complete the m -vector fields $\{F_1, \dots, F_m\}$ to form a smooth frame $\{F_1, \dots, F_n\}$ of TU . The SR-metric g can be extended into a Riemannian metric by taking the system of the F_i 's as an orthonormal frame. We set $P_i = \langle p, F_i(q) \rangle$ for $i = 1, \dots, n$ and let $P = (P_1, \dots, P_n)$. In the coordinate system (q, P) the normal geodesics are solutions of the following equations :

$$\begin{aligned} \dot{q} &= \sum_{i=1}^m P_i F_i(q) \\ \dot{P}_i &= \{P_i, H_n\} = \sum_{j=1}^m \{P_i, P_j\} P_j \end{aligned} \quad (16)$$

We observe that $\{P_i, P_j\} = \langle p, [F_i, F_j](q) \rangle$ and since the F_i 's form a frame we can write :

$$[F_i, F_j](q) = \sum_{k=1}^n c_{ij}^k(q) F_k(q)$$

where the c_{ij}^k 's are smooth functions.

3.3. Exponential mapping - Conjugate and cut loci

Assume that the curves are parametrized by arc-length. If $t \mapsto q(t)$ is any geodesic, the first point where $q(\cdot)$ ceases to be minimizing is called a *cut-point* and the set of such points when we consider all the geodesics with $q(0) = q_0$ will form the *cut-locus* $L(q_0)$.

The *sub-Riemannian sphere* with radius $r > 0$ is the set $S(q_0, r)$ of points which are at SR-distance r from q_0 . The *wave front* of length r is the set $W(q_0, r)$ of end-points of geodesics with length r starting from q_0 . If $D_{A.L.}(q_0)$ is of rank n where $D_{A.L.}$ is the Lie algebra generated by D , then according to *Filippov's existence Theorem* [27] if r is small enough each point of distance r from q_0 is the end-point of a minimizing geodesic and $S(q_0, r)$ is a subset of $W(q_0, r)$. We fix $q_0 \in U$ and let $(q(t, q_0, p_0), p(t, q_0, p_0))$ be the normal geodesic, solution of (15) and starting from (q_0, p_0) at $t = 0$. The *exponential mapping* is the map :

$$\exp_{q_0} : (p_0, t) \mapsto q(t, p_0, q_0)$$

Its domain is the set $C \times \mathbb{R}$ where C is $\{p_0 ; \sum_{i=1}^m P_i^2(p_0, q_0) = 1\}$. If $m < n$ it is a (non compact) *cylinder* contrarily to the Riemannian case : $m = n$, where it is a *sphere*.

A *conjugate point* along a normal geodesic is defined as follows. Let (p_0, t_1) with $t_1 > 0$ be a point where \exp_{q_0} is not an immersion. Then t_1 is called a conjugate time along the normal geodesic and the image is called a conjugate point. The *conjugate locus* $C(q_0)$ is the set of *first conjugate points*.

3.4. Gradated normal form

3.4.1. Adapted and privileged coordinate system

Let (U, q) be a coordinate system centered at q_0 , with $D = \text{Span}\{F_1, \dots, F_m\}$. Assume that D satisfies the rank condition on U . We define recursively : $D_0 = \{0\}$, $D^1 = D$ and for $p \geq 2$ $D^p = \text{Span}\{D^{p-1} + [D^1, D^{p-1}]\}$. Hence D^p is generated by Lie brackets of the F_i 's with length $\leq p$. At p we have an increasing sequence of vector sub-spaces : $\{0\} = D^0(q) \subset D^1(q) \subset \dots \subset D^{r(q)}$ where $r(q)$ is the smallest integer such that $D^{r(q)}(q) = T_q U$.

DEFINITION 3.3. — We say that q_0 is a *regular point* if the integers $n_p(q) = \dim D^p(q)$ remain constant for q in some neighborhood of q_0 . Otherwise we say that q_0 is a *singular point*. Consider now a coordinate system (q^1, \dots, q^n) such that dq^j vanishes identically on $D^{w_j-1}(q_0)$ and doesn't vanish identically on $D^{w_j}(q_0)$ for some integer w_j . Such a coordinate system is said to be *adapted* to the flag and the integer w_j is the *weight* of q^j .

DEFINITION 3.4. — Consider now a SR-metric (D, g) defined on the chart (U, q) and represented locally by the *orthonormal* vector fields $\{F_1, \dots, F_m\}$. If f is a germ of smooth function at q_0 , the *order* of f at q_0 is :

- (i) if $f(q_0) \neq 0, \mu(f) = 0, \mu(0) = +\infty$;
- (ii) otherwise : $\mu(f) = \inf \{p / \exists V_1, \dots, V_p \in \{F_1, \dots, F_m\}$ with $L_{V_1} \circ \dots \circ L_{V_p}(f)(q_0) \neq 0\}$ where L_V denotes the Lie derivative. The germ f is called *privileged* if $\mu(f) = \min\{p ; df(D^p(q_0)) \neq 0\}$. A coordinate system $\{q^1, \dots, q^n\}$ is said to be *privileged* if all the coordinates q_i are privileged at q_0 .

We have the following very important estimation, see [7], [25] :

PROPOSITION 3.1. — *If (M, D, g) is a SR-manifold there exists a privileged coordinate system q at every point $q_0 = 0$ of M . If w_i is the order (or weight) of the coordinate q^i we have the following estimation for the SR-distance :*

$$d_{SR}(0, (q^1, \dots, q^n)) \simeq |q^1|^{1/w_1} + \dots + |q^n|^{1/w_n}.$$

DEFINITION 3.5. — Let (U, q) be a privileged coordinate system for the SR-structure given locally by the m -orthonormal vector fields : $\{F_1, \dots, F_m\}$. If w_j is the weight of q^j , the weight of $\frac{\partial}{\partial q^j}$ is taken by convention as $-w_j$.

Every vector field F_i can be expanded into a Taylor series using the previous gradation and we denote by \hat{F}_i the homogeneous term with lowest order -1 . The polysystem $\{\hat{F}_1, \dots, \hat{F}_m\}$ is called the *principal part* of the SR-structure.

We have the following result, see [7].

PROPOSITION 3.2. — *The vector fields $\hat{F}_i, i = 1, \dots, m$ generate a nilpotent Lie algebra which satisfies the rank condition. This Lie algebra is independent of the privileged coordinate system.*

3.4.2. Gauge classification

Given a local SR-geometry (U, D, g) represented as the optimal control problem :

$$\dot{q} = \sum_{i=1}^m u_i F_i(q)$$

$$\min_{u(\cdot)} \int_0^T \left(\sum_{i=1}^m u_i^2(t) \right) dt ,$$

there exists a pseudo-group of transformations called the *gauge group* which is the subgroup of the feedback group defined by the following transformations :

- (i) germs of diffeomorphisms $\varphi : q \mapsto Q$ on U , preserving q_0 ;
- (ii) feedback transformations $u = \beta(q)v$ preserving the metric g i.e, $\beta(q) \in \theta(m, \mathbb{R})$ (orthogonal group).

The *invariants* of the associated classification problem are the geodesics. They split into two categories : abnormal geodesics which are feedback invariants and normal geodesics.

If q is an adapted coordinate system, a *graded normal form of order $p \geq -1$* is the polysystem $\{F_1^p, \dots, F_m^p\}$ obtained by truncating the vector fields F_i at order p using the weight system defined by the adapted coordinates.

4. The role of abnormal minimizers in SR Martinet geometry

In this Section we analyze the role of abnormal minimizers in SR Martinet geometry which is the prototype of the generic rank 2 situation. Before to present this analysis it is important to make a short visit to the contact situation in \mathbb{R}^3 .

4.1. The contact situation in \mathbb{R}^3

The contact situation in \mathbb{R}^3 has been analyzed in details in several articles [3, 4]. This analysis is based on computations about the exponential mapping using a gradated normal form. To understand the remaining of this article it is important to make the contact situation fit into the following framework.

First, without losing any generality we can use to understand a generic contact SR-problem a gradated form of order 1 computed in [4] where the SR-metric is defined by the two orthonormal vector fields : F_1, F_2 where :

$$F_1 = \frac{\partial}{\partial x} + \frac{y}{2}(1+Q)\frac{\partial}{\partial z}, \quad F_2 = \frac{\partial}{\partial y} - \frac{x}{2}(1+Q)\frac{\partial}{\partial z}$$

where Q is a quadratic form : $ax^2 + 2bxy + cy^2$ depending on 3 parameters. The weight of x, y is one and the weight of z is two. When $a = b = c = 0$, it corresponds to the contact situation of order -1 which is the well-known *Heisenberg case* but *also a gradated normal form of order 0*.

To get an adapted frame we complete F_1, F_2 by $F_3 = \frac{\partial}{\partial z}$. Computing we get : $[F_1, F_2] = (1+2Q)\frac{\partial}{\partial z}$. Using $P_i = \langle p, F_i(q) \rangle$, the geodesics equations are :

$$\begin{aligned} \dot{x} &= P_1 \\ \dot{y} &= P_2 \\ \dot{z} &= \frac{P_1 y(1+Q)}{2} - \frac{P_2 x(1+Q)}{2} \\ \dot{P}_1 &= \{P_1, P_2\}P_2 = (1+2Q)P_2P_3 \\ \dot{P}_2 &= \{P_2, P_1\}P_1 = -(1+2Q)P_1P_3 \\ \dot{P}_3 &= 0 \end{aligned}$$

In the Heisenberg case we have $Q = 0$, and if we set $P_3 = \lambda$ we get : $\ddot{P}_1 + \lambda^2 P_1 = 0$, which is a *linear pendulum*.

Using the *cylindric coordinates* : $P_1 = \sin \theta, P_2 = \cos \theta, P_3 = \lambda$, where $\theta \neq k\pi$, the geodesics *parametrized by arc-length* are solutions of the following equations :

$$\begin{aligned} \dot{x} = P_1 \quad \dot{y} &= P_2 \quad \dot{z} = \frac{P_1 y(1+Q)}{2} - \frac{P_2 x(1+Q)}{2} \\ \dot{\theta} &= (1+2Q)\lambda \end{aligned} \tag{17}$$

where λ is a constant. The important behavior is when $\lambda \rightarrow \infty$. We may assume $\lambda > 0$. By making the following *reparametrization* :

$$ds = \lambda(1 + 2Q)dt \tag{18}$$

the angle equation takes the trivial form : $\frac{d\theta}{ds} = 1$. Hence it is *integrable* and we obtain $\theta(s) = s + \theta_0$.

The remaining equations take the form :

$$\begin{aligned} \frac{dx}{ds} &= \frac{\sin \theta(s)}{(1 + 2Q)\lambda} \\ \frac{dy}{ds} &= \frac{\cos \theta(s)}{(1 + 2Q)\lambda} \\ \frac{dz}{ds} &= \frac{\sin\theta(s)(y(1 + Q)) - \cos \theta(s)(x(1 + Q))}{(1 + 2Q)\lambda} \end{aligned} \tag{19}$$

For large λ , they can be integrated as follows. We set $\varepsilon = 1/\lambda$: small parameter, $x = \varepsilon X, y = \varepsilon Y, z = \varepsilon^2 Z, \frac{1}{1 + 2Q} = 1 + \tilde{Q} = 1 + Ax^2 + 2Bxy + Cy^2 + \dots$ and we get :

$$\begin{aligned} \dot{X} &= \sin(s + \theta_0)[1 + \varepsilon^2 \tilde{Q}(X, Y) + o(\varepsilon^2)] \\ \dot{Y} &= \cos(s + \theta_0)[1 + \varepsilon^2 \tilde{Q}(X, Y) + o(\varepsilon^2)] \\ \dot{Z} &= \frac{\sin(s + \theta_0)Y - \cos(s + \theta_0)X}{2} + o(\varepsilon) \end{aligned}$$

The previous equations *can be integrated by quadratures* by setting :

$$\begin{aligned} X &= X_0 + \varepsilon^2 X_1 + o(\varepsilon^2) \\ Y &= Y_0 + \varepsilon^2 Y_1 + o(\varepsilon^2) \\ Z &= Z_0 + o(\varepsilon) \end{aligned}$$

and we get in particular

$$\begin{aligned} \dot{X}_0 &= \sin(s + \theta_0) \\ \dot{Y}_0 &= \cos(s + \theta_0) \\ \dot{Z}_0 &= \frac{\sin(s + \theta_0)Y_0(s) - \cos(s + \theta_0) X_0(s)}{2} \\ \dot{X}_1 &= \sin(s + \theta_0) \tilde{Q}(X_0, Y_0) \\ \dot{Y}_1 &= \cos(s + \theta_0) \tilde{Q}(X_0, Y_0). \end{aligned}$$

The solutions are computed in the s -parametrization and the arc-length t can be computed by integrating (19) by quadratures.

If we want to mimic this procedure in the Martinet situation, we shall encounter *integrability obstructions due to the existence of abnormal geodesics*.

The sphere in the flat contact situation is represented on Fig. 3.

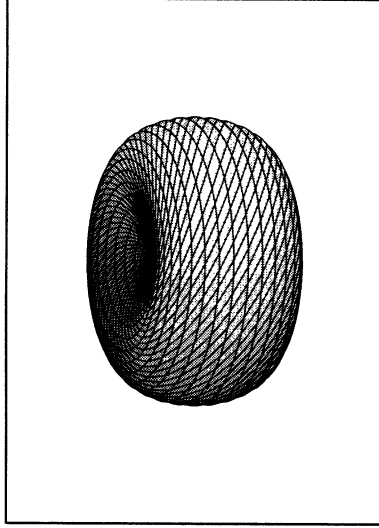

Figure 3. – SR sphere in the flat contact case

4.2. The Martinet situation

4.2.1. Normal forms and invariants

The Martinet SR-geometry is rather intricate and it is difficult to make a priori normalizations. It will appear later that a good starting point to make the computations is to use the following normal form computed in [2] :

- The distribution D is taken in the Martinet-Zhitomirski normal form :

$$D = \text{Ker } \omega, \quad \omega = dz - \frac{y^2}{2} dx.$$
- The metric on D is taken as a *sum of squares* : $a(q)dx^2 + c(q)dy^2$.

In this representation the Martinet surface containing the abnormal geodesics is the plane : $y = 0$ and the abnormal geodesics are the straight-lines : $z = z_0$. The abnormal line passing through 0 is given by $\gamma : t \mapsto (\pm t, 0, 0)$.

The computations in [2] show that we can make an additional normalization on the metric by taking either the restriction of a or c to the Martinet plane $y = 0$ equal to 0.

The variables are gradated according to the following weights : the weight of x, y is one and the weight of z is three. By identifying by convention at order p two normal forms where the Taylor series of a and c coincide at order p we end up with the following representatives of *order 0* :

either

$$g = (1 + \alpha y)^2 dx^2 + (1 + \beta x + \gamma y)^2 dy^2$$

or

$$g = (1 + \bar{\alpha}x + \bar{\beta}y)^2 dx^2 + (1 + \bar{\gamma}y)^2 dy^2$$

In each of those representations the *three parameters are, up to sign, invariants*. They can be used to compute the exponential mapping in the generic situation. If we truncate g to $dx^2 + dy^2$ it corresponds to the principal part of order -1 of the SR-structure defined previously. In the sequel it will be called the *flat case*.

4.2.2. Geodesics equations

The distribution D is generated by :

$$G_1 = \frac{\partial}{\partial x} + \frac{y^2}{2} \frac{\partial}{\partial z} \quad \text{and} \quad G_2 = \frac{\partial}{\partial y}$$

and the metric is given by $g = adx^2 + cdy^2$. We introduce the frame :

$$F_1 = \frac{1}{\sqrt{a}} G_1, \quad F_2 = \frac{1}{\sqrt{c}} G_2, \quad F_3 = \frac{\partial}{\partial z}$$

and $P_i = \langle p, F_i(q) \rangle$ for $i = 1, 2, 3$, i.e

$$P_1 = \frac{p_x + p_z y^2 / 2}{\sqrt{a}}, \quad P_2 = \frac{p_y}{\sqrt{c}}, \quad P_3 = p_z.$$

First, we assume that g is not depending on z ; this is the case for the gradated normal form of order 0. It corresponds to an *isoperimetric situation*, that is the existence of a vector field Z identified here to $\frac{\partial}{\partial z}$ transverse at 0 to $D(0)$ and the metric g does not depend on z .

The system is written :

$$\dot{x} = u_1, \quad \dot{y} = u_2, \quad \dot{z} = \frac{y^2}{2}u_1$$

and the Hamiltonian associated to normal geodesics is :

$$H_n(q, p) = \frac{1}{2}(u_1^2 a + u_2^2 c)$$

and the geodesics controls are :

$$u_1 = \frac{1}{a} (p_x + p_z y^2/2), \quad u_2 = \frac{p_y}{c}.$$

Normal geodesics are solutions of the following equations :

$$\begin{aligned} \dot{x} &= \frac{1}{a}(p_x + p_z y^2/2), \quad \dot{y} = \frac{p_y}{c}, \quad \dot{z} = \frac{y^2}{2a}(p_x + p_z y^2/2) \\ \dot{p}_x &= \frac{p_y^2 c_x}{2c^2} + \frac{(p_x + p_z y^2/2)^2}{2a^2} a_x \\ \dot{p}_y &= \frac{p_y^2 c_y}{2c^2} + \frac{(p_x + p_z y^2/2)^2}{2a^2} a_y - \frac{(p_x + p_z y^2/2)}{a} p_z y \\ \dot{p}_z &= 0 \end{aligned} \tag{20}$$

In the (q, P) representation the previous equations take the form :

$$\begin{aligned} \dot{x} &= \frac{P_1}{\sqrt{a}}, \quad \dot{y} = \frac{P_2}{\sqrt{c}}, \quad \dot{z} = \frac{y^2}{2} \frac{P_1}{\sqrt{a}} \\ \dot{P}_1 &= \frac{P_2}{\sqrt{a}\sqrt{c}} \left(y P_3 - \frac{a_y}{2\sqrt{a}} P_1 + \frac{c_x}{2\sqrt{c}} P_2 \right) \\ \dot{P}_2 &= -\frac{P_1}{\sqrt{a}\sqrt{c}} \left(y P_3 - \frac{a_y}{2\sqrt{a}} P_1 + \frac{c_x}{2\sqrt{c}} P_2 \right) \\ \dot{P}_3 &= 0 \end{aligned} \tag{21}$$

If we parametrize by arc-length and if we introduce the cylindric coordinates : $P_1 = \cos \theta, P_2 = \sin \theta, P_3 = \lambda$, we end up with the following equations :

$$\begin{aligned} \dot{x} &= \frac{P_1}{\sqrt{a}}, \quad \dot{y} = \frac{P_2}{\sqrt{c}}, \quad \dot{z} = \frac{y^2}{2} \frac{P_1}{\sqrt{a}} \\ \dot{\theta} &= -\frac{1}{\sqrt{a}\sqrt{c}} \left[y P_3 - \frac{a_y}{2\sqrt{a}} P_1 + \frac{c_x}{2\sqrt{c}} P_2 \right] \\ P_3 &= \lambda \end{aligned} \tag{22}$$

It is proved in [11] that for a generic SR-problem, each geodesic is strict. In our representation we have the following result.

LEMMA 4.1. — *The abnormal geodesic $\gamma : t \mapsto (\pm t, 0, 0)$ is strict if and only if the restriction of a_y to the Martinet plane $y = 0$ is 0.*

Using the gradated normal form of order 0 with the normalizations :

$$a = (1 + \alpha y)^2 \quad , \quad c = (1 + \beta x + \gamma y)^2$$

the equations (22) reduce to :

$$\begin{aligned} \dot{x} &= \frac{\cos \theta}{\sqrt{a}} & \dot{y} &= \frac{\sin \theta}{\sqrt{c}} & \dot{z} &= \frac{y^2 \cos \theta}{2 \sqrt{a}} \\ \dot{\theta} &= -\frac{1}{\sqrt{a}\sqrt{c}} [y\lambda - \alpha \cos \theta + \beta \sin \theta] \end{aligned} \tag{23}$$

The previous equation defines a *foliation* (\mathcal{F}) of codimension one in the plane (y, θ) . Indeed using the parametrization : $\sqrt{a} \sqrt{c} \frac{d}{dt} = \frac{d}{d\tau}$ and denoting ' the derivative with respect to τ , the equations can be written :

$$\begin{aligned} x' &= \sqrt{c} \cos \theta & z' &= \sqrt{c} \frac{y^2}{2} \cos \theta \\ y' &= \sqrt{a} \sin \theta & \theta' &= -[y\lambda - \alpha \cos \theta + \beta \sin \theta] \end{aligned} \tag{24}$$

and they can be *projected* onto the plane (y, θ) . The last two equations are equivalent to :

$$\theta'' + \lambda \sin \theta + \alpha^2 \sin \theta \cos \theta - \alpha \beta \sin^2 \theta + \beta \theta' \cos \theta = 0. \tag{25}$$

This equation will be used in the sequel to study the SR-Martinnet geometry in the generic case of order 0. Unfortunately it depends on the choice of coordinates. Note that in the flat case where $a = c = 1$ the equation reduces to $\theta'' + \lambda \sin \theta = 0$ which is a *nonlinear pendulum*.

4.2.3. Conservative case

The analysis of Subsection 4.1 shows that in the contact case the equation (17) associated to the evolution of θ defines an integrable foliation. In the Martinet case the foliation defined by equation (25) is not in general integrable. This leads to the following definition which is independant of the choice of coordinates.

DEFINITION 4.1. — Let $e(t, \theta, \lambda)$ be a normal geodesic parametrized by arc-length starting from $q(0) = 0$ and associated to $\theta(0) = \theta_0$, $P_3(0) = \lambda$. The problem is said *conservative* if there exists a coordinate y transverse to the Martinet surface such that for a dense set of initial conditions (θ_0, λ) the trajectory $t \rightarrow y(t)$ is periodic up to reparametrization. The equation describing the evolution of y is called the *characteristic equation*.

4.2.4. Analysis of the foliation \mathcal{F}

The foliation (\mathcal{F}) is described by equation (25) :

$$\theta'' + \lambda \sin \theta + \alpha^2 \sin \theta \cos \theta - \alpha \beta \sin^2 \theta + \beta \theta' \cos \theta = 0.$$

Moreover recall the relation : $y' = (1 + \alpha y) \cos \theta$, $\theta' = -(y\lambda - \alpha \cos \theta + \beta \sin \theta)$

The singular line project onto $\theta = k\pi$ which correspond to the *singularities* of (25) : $\theta = k\pi$, $\theta' = 0$.

Among the solutions of (25), only those satisfying the relation :

$$\theta' = \alpha \cos \theta + \beta \sin \theta \tag{26}$$

at $\tau = 0$ correspond to projections of geodesics starting at $t = 0$ from $q(0) = 0$.

Using an energy-balance relation we can represent the solutions of (\mathcal{F}) for $|\lambda| \gg |\alpha|, |\beta|, |\gamma|$, see [10]. We may suppose $\lambda > 0$. Introducing the small parameter : $\varepsilon = 1/\sqrt{\lambda}$ and the parametrization $s = \tau\sqrt{\lambda}$ we get the equation :

$$\frac{d^2\theta}{ds^2} + \sin \theta + \varepsilon\beta\cos \theta \frac{d\theta}{ds} + \varepsilon^2\alpha \sin \theta(\alpha \cos \theta - \beta \sin \theta) = 0 \tag{27}$$

and equation (26) takes the form :

$$\frac{d\theta}{ds} = \varepsilon(\alpha \cos \theta + \beta \sin \theta) \tag{28}$$

The *flat case* corresponds to $\alpha = \beta = 0$, i.e : $\frac{d^2\theta}{ds^2} + \sin \theta = 0$. $\frac{d\theta}{ds} = 0$ at $s = 0$ and is *also the limit case* $\varepsilon \rightarrow 0$.

The following result is straightforward.

LEMMA 4.2. — *The problem is conservative if and only if $\beta = 0$.*

We represent below the trajectories of (\mathcal{F}) for $\lambda \gg |\alpha|, |\beta|, |\gamma|$, on the phase space : $(\theta, \dot{\theta})$ but geometrically it corresponds to a foliation on the *cylinder* : $(e^{i\theta}, \dot{\theta})$.

- Flat case ($\alpha = \beta = 0$). It corresponds to a *pendulum*, see Fig. 4.

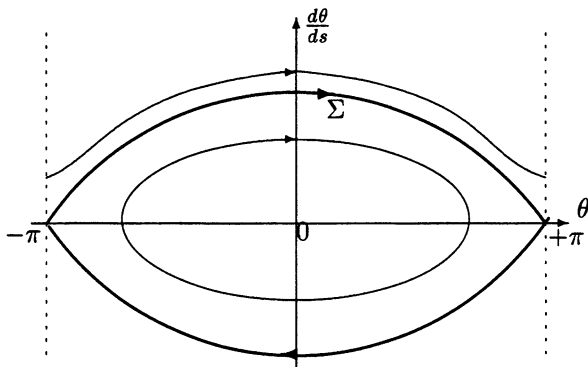

Figure 4

The main properties are the following. We have two singularities :

- 0 is a center.
- $(\pi, 0)$ is a saddle and the separatrix Σ is a saddle connection.

Only the *oscillating trajectories* correspond to geodesics starting from 0.

- Conservative case ($\beta = 0$) The equation reduces to :

$$\frac{d^2\theta}{ds^2} + \sin \theta + \varepsilon^2 \alpha^2 \sin \theta \cos \theta = 0$$

Multiplying both sides by $\frac{d\theta}{ds}$ and integrating on $[0, s]$ we get :

$$\left[\frac{1}{2} \left(\frac{d\theta}{ds} \right)^2 \right]_0^s = \left[\cos \theta + \frac{\varepsilon^2 \alpha^2 \cos^2 \theta}{2} \right]_0^s$$

and the system has a *global C^ω first integral* :

$$V(\theta, \dot{\theta}) = \frac{1}{2} \dot{\theta}^2 - \left(\cos \theta + \frac{\varepsilon^2 \alpha^2}{2} \cos^2 \theta \right). \quad (29)$$

The phase portrait is similar to the one in the flat case but the section defined by (28) and corresponding to $y = 0$ is here : $\frac{d\theta}{ds} = \varepsilon \alpha \cos \theta$.

In particular if $\alpha \neq 0$ (strict case) there exist both oscillating and rotating trajectories corresponding to projections of geodesics starting from 0, see Fig. 5.

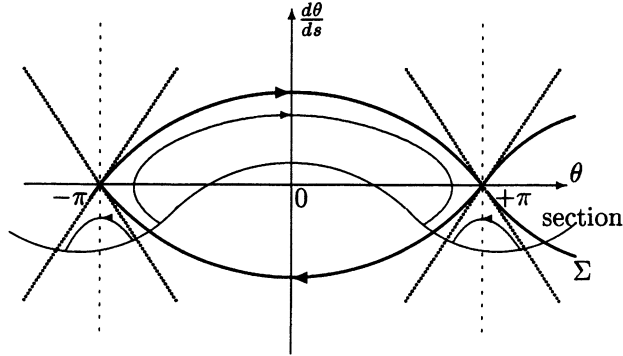

Figure 5. $-\alpha > 0$

- General case ($\beta \neq 0$) The two main differences are the following :
 - the center 0 becomes a focus ;
 - the saddle connection is broken.

The trajectories are represented on Fig. 6.

The respective generic behaviors of $t \mapsto y(t)$ are represented on Fig. 7.

It is important to observe that the behaviour of $t \mapsto y(t)$ is true for the gradated form of order 0, but also of any order when $\lambda \rightarrow \infty$.

4.2.5. Characteristic equation

If $\beta = 0$, the Hamiltonian $H_n = \frac{1}{2}(P_1^2 + P_2^2)$ has two cyclic coordinates : x and z and therefore $p_x = \cos \theta(0)$ and $p_z = \lambda$ are first integrals. The equation $H_n = 1/2$, with $P_1 = \frac{p_x + p_z y^2/2}{\sqrt{a}}$ and $P_2 = \frac{p_y}{\sqrt{c}}$ takes the form :

$$(\sqrt{c} \dot{y})^2 + \left(\frac{p_x + p_z y^2/2}{\sqrt{a}} \right)^2 = 1$$

Introducing : $d\tau = \frac{dt}{\sqrt{a}\sqrt{c}}$ it becomes :

$$\left(\frac{dy}{d\tau} \right)^2 + (p_x + p_z y^2/2)^2 = a$$

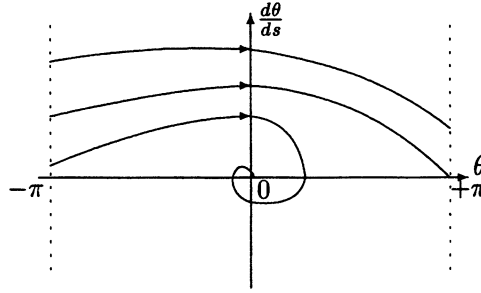

Figure 6. - $\beta > 0$

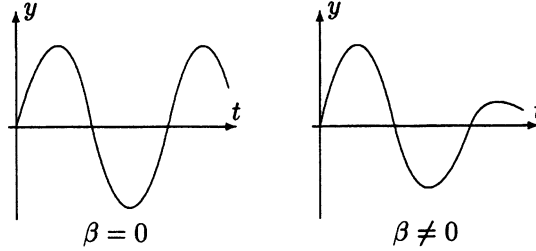

Figure 7. - $\beta \geq 0$

where $a = (1 + \alpha y)^2$. Hence we get :

$$\left(\frac{dy}{d\tau}\right)^2 = F(y) \quad (30)$$

where $F(y) = (1 + \alpha y)^2 - (p_x + p_z y^2/2)^2$. The analysis is based on the *roots of the quartic* $F(y)$. We assume $\lambda > 0$.

We observe that F can be factorized as $F_1 F_2$ with :

$$F_1 = (1 + \alpha y) - (p_x + p_z y^2/2) \quad . \quad F_2 = (1 + \alpha y) + (p_x + p_z y^2/2)$$

and we can write :

$$F(y) = \left(2m^2 - \frac{\lambda}{2}\left(y - \frac{\alpha}{\lambda}\right)^2\right) \left(2m'' + \frac{\lambda}{2}\left(y + \frac{\alpha}{\lambda}\right)^2\right)$$

where : $2m^2 = 1 - p_x + \frac{\alpha^2}{2\lambda}$, $2m'' = 1 + p_x - \frac{\alpha^2}{2\lambda}$

and : $m^2 + m'' = 1$, $m \geq 0$.

If we set : $\eta = \frac{\sqrt{\lambda}y}{2m} - \frac{\alpha}{2m\sqrt{\lambda}}$, $\bar{\eta} = \frac{\sqrt{\lambda}y}{2m} + \frac{\alpha}{2m\sqrt{\lambda}}$

we can write :

$$F(y) = 4m^2(1 - \eta^2)(m'' + m^2\bar{\eta}^2) \quad (31)$$

F is a quartic whose roots on \mathbf{C} are $\eta = \pm 1$, $\bar{\eta} = \pm \frac{\sqrt{m''}}{m}$.

The case $m'' = 0$ is called critical and it corresponds to a double root for F . We have :

LEMMA 4.3. — *In the strict case $\alpha \neq 0$, there exist geodesics starting from 0 which are critical.*

Geometric interpretation

The critical geodesics project in the $(\theta, \dot{\theta})$ phase space onto a separatrix, see Fig. 5.

The characteristic equation can be put into a normal form using an *homographic transformation* to normalize the roots of F . The procedure is standard, see [26]. We proceed as follows ; F is factorized into F_1F_2 and we consider the *pencil* $F_1 + \nu F_2$ of two quadratic forms. If $\alpha \neq 0$, there exist two distinct real numbers ν_1, ν_2 such that $F_1 + \nu F_2$ is a *perfect square* : $K_1(y - p)^2, K_2(y - q)^2$. Using the homographic transformation :

$$u = \frac{y - p}{y - q} \quad , \quad (32)$$

the characteristic equation can be written in the normal form :

$$\frac{dy}{\sqrt{F(y)}} = \frac{(p - q)^{-1} du}{\sqrt{(A_1u^2 + B_1)(A_2u^2 + B_2)}}. \quad (33)$$

The right hand side corresponds to an integrand of an *elliptic integral of the first kind*. More precisely, excepted the critical case $m'' = 0$, the solution y in the u -coordinate can be computed as follows :

- if the quartic F admits two real roots, u can be parametrized using the cn *Jacobi function* ;
- if the quartic F admits four real roots, u can be parametrized using the dn *Jacobi function*.

If $\alpha = 0$, the analysis is simpler, indeed $F(y)$ can be written :

$$F(y) = 4k^2(1 - \eta^2) (k'^2 + k^2 \eta^2)$$

where $\eta = \frac{\sqrt{\lambda}y}{2k}$ and η can be computed using only the cn function.

PROPOSITION 4.4. — *We have two cases :*

(i) *If $\alpha = 0$, $y = \frac{2k}{\sqrt{\lambda}}\eta$ where η is the cn Jacobi function.*

(ii) *If $\alpha \neq 0$, y is generically the image by an homography of the cn or dn Jacobi function.*

Geometric interpretation If $\alpha = 0$, the motion of y is a cn whose amplitude is $\frac{2k}{\sqrt{\lambda}}$. The motion is symmetric with respect to $y = 0$ and the amplitude tends to 0 when λ tends to the infinity, see Fig. 8.

If $\alpha \neq 0$, we can expand : $y = \frac{ua - p}{u - 1}$ near $u = 0$. The motion of y is no more symmetric with respect to $y = 0$ and there is a *shift*. Hence y can be approximated by a constant plus a cn or dn motion.

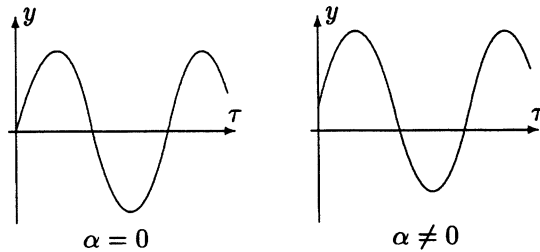

Figure 8. — $\alpha \geq 0$

4.2.6. Integral formulas in the general conservative case

If the metric g does not depend on x , it is convenient to use the following integral formulas from [24] to compute x and z in terms of y .

We denote by $e(t), t \in [0, T]$ a normal geodesic starting from 0 and we assume that the component : $t \mapsto y(t)$ oscillates periodically with period

\mathcal{P} . We denote by $0 < t_1 < \dots < t_N \leq T$ the successive times such that $y(t_i) = 0$. We introduce :

$$\sigma = \begin{cases} \text{sign } \dot{y}(0) & \text{if } \dot{y}(0) \neq 0 \\ \text{sign } \ddot{y}(0) & \text{if } \dot{y}(0) = 0 \end{cases}$$

and we set :

$$y_+ = \max_{t \in [0, P]} y(t) \quad , \quad y_- = \min_{t \in [0, P]} y(t)$$

Parametrizing the geodesics by y we must integrate the equations :

$$\frac{dx}{dy} = \frac{\sqrt{c} P_1}{\sqrt{a} P_2} \quad , \quad \frac{dz}{dy} = \frac{y^2 \sqrt{c} P_1}{2 \sqrt{a} P_2} \quad , \quad dt = \frac{\sqrt{c}}{P_2} dy$$

where $P_2(y) = \sigma \sqrt{1 - P_1^2(y)}$ for $t \in [0, t_1]$.

This allows to get explicit integral formulas. In particular if $y(T) = 0$ for $T = t_N$ we get :

- N odd

$$\begin{aligned} x(T) &= 2 \int_0^{y^\sigma} \sigma \frac{\sqrt{c}}{\sqrt{a}} \frac{P_1(y)}{\sqrt{1 - P_1^2(y)}} dy + (N - 1) \int_{y_-}^{y_+} \frac{\sqrt{c}}{\sqrt{a}} \frac{P_1(y)}{\sqrt{1 - P_1^2(y)}} dy \\ z(T) &= \int_0^{y^\sigma} \sigma \frac{\sqrt{c}}{\sqrt{a}} \frac{y^2 P_1(y)}{\sqrt{1 - P_1^2(y)}} dy + (N - 1) \int_{y_-}^{y_+} \frac{\sqrt{c}}{2\sqrt{a}} \frac{y^2 P_1(y)}{\sqrt{1 - P_1^2(y)}} dy \end{aligned} \quad (34)$$

- N even

$$\begin{aligned} x(T) &= N \int_{y_-}^{y_+} \frac{\sqrt{c}}{\sqrt{a}} \frac{P_1(y)}{\sqrt{1 - P_1^2(y)}} dy \\ z(T) &= N \int_{y_-}^{y_+} \frac{\sqrt{c}}{2\sqrt{a}} \frac{y^2 P_1(y)}{\sqrt{1 - P_1^2(y)}} dy \end{aligned} \quad (35)$$

and the period is given by :

$$\mathcal{P} = 2 \int_{y_-}^{y_+} \frac{\sqrt{c}}{\sqrt{1 - P_1^2(y)}} dy. \quad (36)$$

The integrands have simple poles when $P_1(y) = \pm 1$ so the integrals are well-defined.

4.2.7. The return mapping

The main geometric object to understand the role of abnormal trajectories in the problem is the *return mapping*. Indeed if we consider the trace of the sphere and the wave front in the plane $y = 0$:

$$\tilde{S}(0, r) = S(0, r) \cap (y = 0) , \quad \widetilde{W}(0, r) = W(0, r) \cap (y = 0) ,$$

they are in the image of the following mappings.

DEFINITION 4.2. — Let $e : (t \in [0, T], \theta(0), \lambda) \mapsto (x(t), y(t), z(t))$ be a normal geodesic, parametrized by arc-length. If $y(t) \neq 0$, we can define $0 < t_1 < \dots < t_N \leq T$ as the times corresponding to $y(t_i) = 0$. The first return mapping is :

$$R_1 : (\lambda, \theta(0)) \in D_1 \mapsto (x(t_1), z(t_1))$$

and more generally the n-th return mapping is the map :

$$R_n : (\lambda, \theta(0)) \in D_n \mapsto (x(t_n), z(t_n))$$

where D_i are the domains.

If the length is fixed to r , we observe that $\widetilde{W}(0, r)$ is the union of the image of the return mappings and $(\pm r, 0)$ which are the end-points of the abnormal geodesics.

The remaining of this Section is devoted to the analysis of the return mapping. We proceed by perturbations of the flat case. We shall estimate the asymptotic expansions of \tilde{S} and \widetilde{W} in the abnormal direction. They are an union of curves in the plane. Such a curve is subanalytic if and only if it admits a Puiseux expansion. *It is a practical criterion to measure the transcendence of the sphere and wave front in the abnormal direction.*

4.2.8. The pendulum and the elastica in the flat case

In the flat case the equation (27) is a simple pendulum :

$$\frac{d^2\theta}{ds^2} + \sin \theta = 0$$

where $s = t\sqrt{\lambda}$, t is the arc-length parameter and $y = -\frac{d\theta}{\sqrt{\lambda}ds}$. In particular

if $y(0) = 0$, we have $\frac{d\theta}{ds} = 0$. We get :

$$\left(\frac{d\theta}{ds}\right)^2 = 2(\cos \theta - \cos \theta(0))$$

The integration is standard using elliptic integrals [26]. The characteristic equation takes the form :

$$\dot{y}^2 = \left(1 - p_x - \frac{y^2}{2} p_z\right) \left(1 + p_x + \frac{y^2}{2} p_z\right)$$

and we introduce $k, k' \in [0, 1]$ by setting :

$$2k^2 = 1 - p_x, \quad 2k'^2 = 1 + p_x$$

where $p_x = \cos \theta(0)$. We set : $\eta = \frac{y\sqrt{\lambda}}{2k}$ and we get the equation :

$$\frac{\dot{\eta}^2}{\lambda} = (1 - \eta^2) (k'^2 + k^2 \eta^2)$$

We integrate with $\eta(0) = y(0) = 0$ and we choose the branch $\dot{\eta}(0) > 0$ corresponding to $\dot{y}(0) = \sin \theta(0) > 0$. We get using the cn *Jacobi function* :

$$\eta(t) = -\text{cn} (K(k) + t\sqrt{\lambda}, k)$$

where $4K(k)$ is the period, K being the complete elliptic integral of the first kind :

$$K(k) = \int_0^1 \frac{d\eta}{\sqrt{(1 - \eta^2)(k'^2 + k^2 \eta^2)}} = \int_0^{\pi/2} (1 - k^2 \sin^2 \theta)^{-\frac{1}{2}} d\theta$$

Hence

$$y(t) = -\frac{2k}{\sqrt{\lambda}} \text{cn} (u, k), \quad u = K + t\sqrt{\lambda} \quad (37)$$

which coincides with the formula obtained by integrating the pendulum.

The components y and z can be computed by quadratures and we get :

$$\begin{aligned} x(t) &= -t + \frac{2}{\sqrt{\lambda}} (E(u) - E) \\ z(t) &= \frac{2}{3\lambda^{3/2}} [(2k^2 - 1) (E(u) - E(K)) + k'^2 t\sqrt{\lambda} + 2k^2 \text{sn } u \text{ cn } u \text{ dn } u] \end{aligned} \quad (38)$$

where E is the complete elliptic integral of the second kind :

$$E(k) = \int_0^{K(k)} \text{dn}^2 u \, du = \int_0^{\pi/2} (1 - k^2 \sin^2 \theta)^{1/2} d\theta$$

The previous parametrization corresponds to geodesics with $\lambda > 0, \theta(0) \in]0, \pi[$. The solutions corresponding to $\lambda > 0, \theta(0) \in]-\pi, 0[$ are deduced using the symmetry : $S_1 : (x, y, z) \mapsto (x, -y, z)$. The solutions corresponding to $\lambda < 0$ are deduced using the symmetry : $S_2 : (x, y, z) \mapsto (-x, y, -z)$. The solutions with $\lambda = 0$ play no role in our analysis.

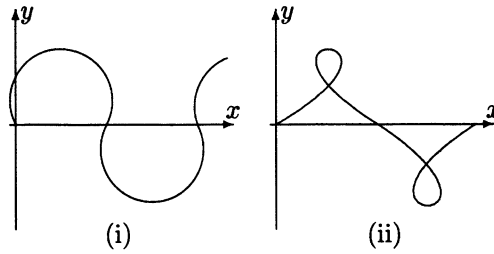

Figure 9. - Elastica

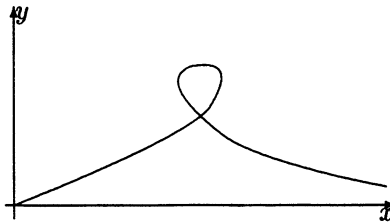

Figure 10. - Behaviour on the separatrix

Elastica

The projections of the geodesics on the plane (x, y) are parametrized by :

$$y(t) = -\frac{2k}{\sqrt{\lambda}} \operatorname{cn}(u, k), \quad x(t) = -t + \frac{2}{\sqrt{\lambda}}(E(u) - E)$$

They are precisely the *inflectional elastica* described in [31].

They take various shapes whose typical ones are represented on Fig. 9.

When $k' \rightarrow 0$ the limit behavior is represented on Fig. 9 (ii), see also Fig. 10 (behaviour on the separatrix).

In this representation θ is up to a constant the angle of the normal with respect to a fixed direction. The rotating trajectories of the pendulum

correspond to geodesics not starting from 0. They project on the space (x, y) onto *non inflexional elastica*, see Fig. 11 (ii).

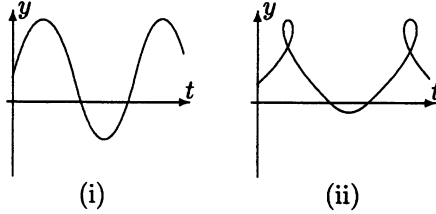

Figure 11

4.2.9. Trace of $S(0, r)$ and $W(0, r)$ in $y = 0$ in the flat case

The successive intersection times with $y = 0$ are given by : $t_i = \frac{2K}{\sqrt{\lambda}}$, $i = 1, \dots, N$. If we fix the length to $t_i = r$, we get the following curves :

$$x = -r + \frac{2}{\sqrt{\lambda}} (E(K + i2K) - E)$$

$$z = \frac{2}{3\lambda^{3/2}} \left[(2k^2 - 1) (E(K + i2K) - E) + 2Ki k'^2 \right]$$

It represents a parametric curve, where the parameter is $k \in]0, 1[$. Using the relation : $E(K + i2K) = (2i + 1)E$ we obtain for each i the following curves : $k \mapsto C_i(k) = (x_i(k), z_i(k))$,

$$x_i(k) = -r + 2r \frac{E}{K}$$

$$z_i(k) = \frac{r^3}{6i^2 K^3} \left[(2k^2 - 1)E + k'^2 K \right]$$

where $k \in]0, 1[$. We can easily draw those curves using the standard package about elliptic functions in Mathematica, see Fig. 12.

The *exterior* curve obtained for $i = 1$ represents the intersection of the sphere $S(0, r)$ with the Martinet plane in the domain $z > 0$. Each point of this curve is the end-point of *two distinct minimizers* and by obvious geometric reasoning we have :

PROPOSITION 4.5. — *The cut locus $L(0, r)$ is $C_1 \cup -C_1$.*

Moreover by inspecting Fig. 12 we deduce the following :

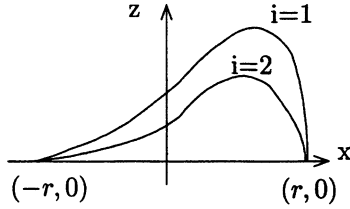

Figure 12

PROPOSITION 4.6. — *The abnormal geodesics are minimizers.*

This result is now new but here the proof is based on the analysis of the geodesic flow. *The main property is that at each intersection with $y = 0$, the variable z has non zero drift which can be easily evaluated using (38). This will lead to optimality results for the general metric, by stability.*

This is an alternative proof to the optimality results presented in Section 3 or in [5], [29], where we consider all the trajectories of the system.

Remark 4.1. — We observe that $(-r, 0)$ is a ramified point of the trace of the wave front on the Martinet plane with an *infinite number of branches*. This gives us a precise geometric interpretation on the structure of the geodesics of fixed length with respect to the abnormal line. *Indeed for every neighborhood U of $(-r, 0, 0)$ and every $n \in \mathbb{N}$, there exists a geodesic of length r with end-point in U , with n oscillations.*

We represent on Fig. 13 the first and second return mapping, the length being fixed to r , and by restricting the domain to $\lambda > 0, \theta(0) \in [0, \pi]$.

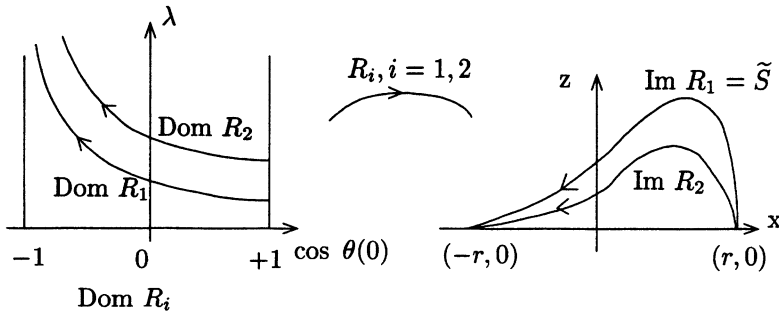

Figure 13

In the phase space $(\theta, \dot{\theta})$, R_1 corresponds to the symmetry : $(\theta, 0) \mapsto (-\theta, 0)$

and R_2 corresponds to the identity : $(\theta, 0) \mapsto (\theta, 0)$.

We represent on Fig. 14 the two branches C_1 and \bar{C}_1 in $\tilde{S}(0, r)$ ending at $(-r, 0)$ and $(r, 0)$ and corresponding respectively to the behaviors of the geodesics near the center 0 and the separatrix Σ .

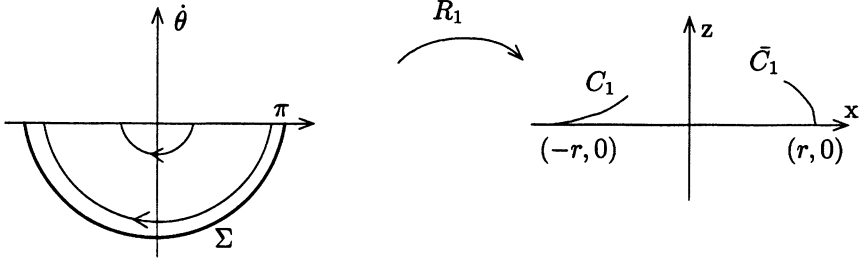

Figure 14

Inspection of Fig. 13 leads to the following.

PROPOSITION 4.7. — *For each $n \geq 1$, the return mapping R_n is not proper.*

Proof. — The inverse image of a compact ball centered at $(-r, 0)$ corresponds to an asymptotic branch in the parameter space $(\theta(0), \lambda)$. The transcendence of this branch can be easily computed. Indeed when $k' \rightarrow 0$, $K(k') \simeq \ln 1/k'$ and the branch is *logarithmic*. \square

4.2.10. Asymptotics of the sphere and wave front near $(r, 0)$ and $(-r, 0)$

We can estimate the branches \bar{C}_1 and C_1 . The computations are geometrically different. Indeed the computation of \bar{C}_1 requires the estimation of the leaves of the foliation \mathcal{F} , localized near the center but the computation of C_1 requires the estimation of the leaves near the separatrix Σ connecting the saddle points $(-\pi, 0)$ and $(\pi, 0)$. To make the estimation we use the parametric representation :

$$x(k) = -r + 2r \frac{E}{K}$$

$$z(k) = \frac{r^3}{6K^3} [(2k^2 - 1)E + k'^2 K]$$

where $k \in]0, 1[$ and \bar{C}_1 (resp. C_1) is obtained by making $k \rightarrow 0$ (resp. $k \rightarrow 1$).

The transcendence of the branches is related to the properties of the complete integrals :

$$K = \int_0^1 \frac{d\eta}{\sqrt{(1-\eta^2)(k'^2 + k'^2 + k^2\eta^2)}} = \int_0^{\pi/2} (1 - k^2 \sin^2 \theta)^{-1/2} d\theta$$

and

$$E = \int_0^K dn^2 u du = \int_0^{\pi/2} (1 - k^2 \sin^2 \theta)^{1/2} d\theta$$

Both E and K are solutions of hypergeometric equations whose singular points are located at $k = 0$ and 1 . Using this properties we deduce the following [18].

LEMMA 4.8. — *When $k \rightarrow 0$, E and K are given by the following converging asymptotic expansions :*

$$\begin{aligned} K(k) &= \frac{\pi}{2} \left[1 + \left(\frac{1}{2}\right)^2 k^2 + \left(\frac{1}{2} \cdot \frac{3}{4}\right)^2 k^4 + \dots \right] \\ E(k) &= \frac{\pi}{2} \left[1 - \left(\frac{1}{2}\right)^2 k^2 - \frac{1}{3} \left(\frac{1}{2} \cdot \frac{3}{4}\right)^2 k^4 + \dots \right]. \end{aligned}$$

LEMMA 4.9. — *When $k' = \sqrt{1 - k^2} \rightarrow 0$ we have :*

$$\begin{aligned} E(k) &= u_1(k'^2) \ln \frac{4}{k'} + u_2(k'^2) \\ K(k) &= u_3(k'^2) \ln \frac{4}{k'} + u_4(k'^2) \end{aligned}$$

where the u_i 's are analytic near 0 and can be written as :

$$\begin{aligned} u_1(k'^2) &= \frac{k'^2}{2} + O(k'^4), & u_2(k'^2) &= 1 - \frac{k'^2}{4} + O(k'^4) \\ u_3(k'^2) &= 1 + \frac{k'^2}{4} + O(k'^4), & u_4(k'^2) &= -\frac{k'^2}{4} + O(k'^4). \end{aligned}$$

Remark 4.2. — The complete expansions are given in [18]. The general theory about Fuchsian differential equations guarantees the convergence of the previous expansions and the coefficients can be recursively computed using the ODE. Another method which can be applied in the general conservative case is to use the integral formulas.

Estimation of \bar{C}_1

When $k \rightarrow 0$, E and $1/K$ are analytic and we have the following

estimations using Lemma 4.8 :

$$\begin{aligned}\frac{E}{K} &= 1 - \frac{k^2}{2} + o(k^2) \\ x(k) - r &= -rk^2 + o(k^2) \\ z(k) &= \frac{2r^3}{3\pi^2} k^2 + o(k^2)\end{aligned}$$

In particular we deduce the following :

PROPOSITION 4.10. — *When $k \rightarrow 0$, the branch \bar{C}_1 is semi-analytic and is given by a graph of the form :*

$$z = -\frac{2r^2}{3\pi^2} (x - r) + o(x - r), \quad x \leq r$$

Estimation of C_1

When $k' \rightarrow 0$, we cannot work in the analytic category but in the *log-exp category* introduced in [19]. Using [28], the elimination of the parameter k' is allowed in this category and will lead to a log-exp graph. The precise algorithm to evaluate C_1 has been established in [2] and we proceed as follows.

We set $X = \frac{x+r}{2r}$, $Z = \frac{z}{r^3}$, and we get :

$$X = \frac{E}{K}, \quad Z = \frac{1}{6K^3} [(2k^2 - 1)E + k'^2 K]$$

If we introduce : $X_1 = k'$, $X_2 = \frac{1}{\ln 4/k'}$, we have $X_1, X_2 \rightarrow 0$ when $k' \rightarrow 0^+$ and both X and Z are analytic functions of X_1 and X_2 .

An easy computation shows that :

$$X_1 \simeq 4e^{-\frac{1}{X}}, \quad X_2 \simeq X \quad \text{when } X \rightarrow 0^+$$

and we can write :

$$X_1 = 4e^{-\frac{1}{X}} (1 + Y_1(X)), \quad X_2 = X(1 + Y_2(X))$$

where $Y_1, Y_2 \rightarrow 0$ when $X \rightarrow 0^+$.

Both Y_1 and Y_2 can be compared and a computation gives us :

$$Y_2 = X A_1(X, Y_1), \quad Y_1 \simeq \frac{Y_2}{X} \quad \text{when } X \rightarrow 0^+$$

where A_1 is a germ of an analytic function at 0.

Now the equation $X = E/K$ can be solved in the variables Y_1, X_1, X_2 using the Implicit Function Theorem in the analytic category and the computations show that :

$$Y_1 = A_2(X, \frac{e^{-\frac{1}{X}}}{X})$$

where A_2 is a germ of an analytic function at 0. Using this relation we end with :

$$Z = F(X, \frac{e^{-\frac{1}{X}}}{X})$$

where F is a germ of an analytic function at 0.

This is the constructive algorithm to compute the branch C_1 as a graph in the log-exp category. Hence Z can be expanded as :

$$Z = \sum_{p=0}^{+\infty} u_p(X) \left(\frac{e^{-\frac{1}{X}}}{X} \right)^p$$

To ensure that C_1 is not semi-analytic we must check that there exists a non zero term of the form $a_{k,p} X^k (e^{-\frac{1}{X}})^p$, $p > 0$ in the expansion. For this we compute the *first* non zero coefficient according to the lexicographic order on the pair (p, k) . The simplest computation made in [2] is to observe that :

$$X = \frac{E}{K}, \quad 6Z = \frac{1 - 2k'^2}{E^2} \left(\frac{E}{K} \right)^3 + \frac{k'^2}{K^2}$$

but the algorithm which can be generalized is the following. We use the approximations :

$$\begin{aligned} E &= 1 + \frac{k'^2}{2} \ln 4/k' - \frac{k'^2}{4} + o(k'^2) \\ K &= \ln 4/k' + \frac{k'^2}{4} \ln 4/k' + o(k'^2 \ln 4/k'). \end{aligned}$$

Easy computations lead to the formula :

$$6Z = X^3 - \frac{5}{4} \frac{k'^2}{(\ln 4/k')^4} + o\left(\frac{k'^2}{\ln 4/k'}\right)$$

Using $k' \simeq 4e^{-\frac{1}{X}}$, $\frac{1}{\ln 4/k'} \simeq X$ we obtain :

$$Z = \frac{1}{6} X^3 - 4e^{-\frac{1}{X}} X^3 + o(X^3 e^{-\frac{1}{X}})$$

Remark 4.3. — We observe the following :

- $u_0(X) = X^3/6$ is algebraic.
- There is a phenomenon of compensation and the first non zero flat term is of the form $X^3e^{-\frac{1}{X}}$ and not $X^2e^{-\frac{1}{X}}$; that's why we need three terms in E and two terms in K .
- In general the computation of the first non zero $a_{p,k}$ can be done in a finite number of steps, for instance using a finite number of coefficients of $u_0(X)$.

4.2.11. Numerical aspects

Fig. 15 represents the numerical simulation of the flat Martinet sphere. We observe a numerical problem when computing near the abnormal direction.

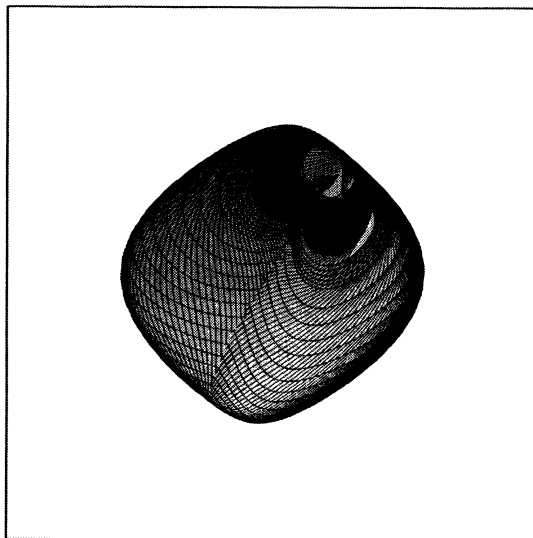

Figure 15. – Flat Martinet sphere

4.2.12. Asymptotics of the sphere and wave front in the abnormal direction in the conservative case

Geometric preliminaries

We can estimate the sphere and the wave front in the abnormal direction when $g = (1 + \alpha y)^2 dx^2 + (1 + \gamma y)^2 dy^2$ (or in the general case) using

the integral formulas (34). We observe that the geometry remains invariant for the following symmetry : $S_1 : (x, y, z) \mapsto (-x, y, -z)$ and in our study we can assume $\lambda \geq 0$. Another symmetry is the following. Adding to the geodesics the equations : $\dot{\alpha} = 0, \dot{\gamma} = 0$ we can observe that the geodesics equations are left invariant by the transformation : $(x, y, z, p_x, p_y, p_z, \alpha, \gamma) \mapsto (x, -y, z, p_x, -p_y, p_z, -\alpha, -\gamma)$. Hence we can fix the sign of one of the parameters and we shall make the following choice : $\alpha \geq 0$.

Let $e(t) = (x(t), y(t), z(t))$ be a normal geodesic starting from 0 and associated to $p_y(0) = \sin \theta(0), p_x = \cos \theta(0)$ and $p_z = \lambda$. We observe the following. If λ is non zero the y component of a geodesic oscillates periodically unless it corresponds to a separatrix Σ between two values y_- and y_+ and we have $y_- < 0 < y_+$ if $\dot{y}(0) \neq 0$. If $\dot{y}(0) = 0$, then $\text{sign } \ddot{y}(0) = \text{sign } \alpha > 0$ when $\alpha > 0$.

Moreover using Fig. 5 or the integral formulas (35), we deduce the following Proposition.

PROPOSITION 4.11. — *Let $e(t) = (x(t), y(t), z(t))$ be a geodesic starting from 0 such that y oscillates periodically, $\dot{y}(0) \neq 0$ and corresponding to the initial conditions $\dot{y}(0), p_x$ and p_z . Let $\tilde{e}(t) = (\tilde{x}(t), \tilde{y}(t), \tilde{z}(t))$ be the geodesic associated to $-\dot{y}(0), p_x$ and p_z . Then e and \tilde{e} are distinct but their even intersections with the plane $y = 0$ are identical and have the same length. In particular $e(\cdot)$ is not a minimizer beyond its second intersection with the plane $y = 0$.*

This is illustrated on Fig. 16 where we project a geodesic in the plane (x, y) .

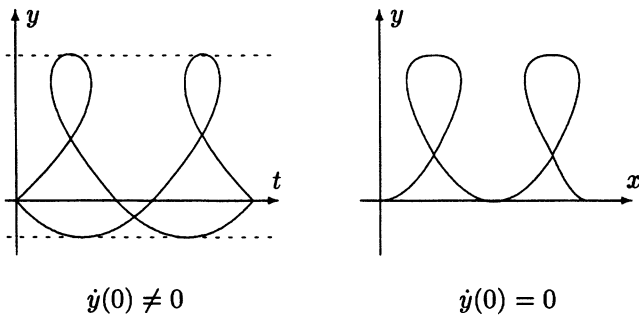

Figure 16

Conclusion

The previous Proposition tells us that except when $p_y(0) = \sin \theta(0) = 0$, the sphere is contained in the image of R_1 and R_2 . The others cases can be studied by continuity or using a numerical algorithm developed in [17] to compute the conjugate points.

We shall now estimate the image of R_1 and R_2 near the two singularities of the foliation \mathcal{F} .

Estimation of R_1

The constraint $y = 0$ takes the form $S : \frac{d\theta}{ds} = \varepsilon \alpha \cos \theta$ where $\cos \theta$ can be approximated by ± 1 near $\theta = 0, \pi$. Contrarily to the flat case we must distinguish the case $\theta(0) \in]-\pi, 0[$ where $\sigma = \text{sign } \dot{y}(0) = +1$ from the case $\theta(0) \in]0, \pi[$ where $\sigma = -1$. We use following notations :

- $C(D)$ branches corresponding to an oscillating (resp. rotating) pendulum or CD : mixed behaviors.
- Symbols without bars : behavior near the separatrix, symbols with bar : behaviours near the focus.
- When $\sigma = +1$, we use the symbol '.

They are images by R_1 of curves in the parameters $\lambda, \theta(0)$ denoted by the same but minuscule symbol. We obtain the Fig. 17.

Estimation of R_2

The analysis is simpler because the branches corresponding to $\sigma = +1$ and $\sigma = -1$ are similar.

We get the Fig. 18.

Estimation problems

We must estimate the branches $C_1, D_1, C'_1 D'_1, \bar{C}_1, \bar{C}'_1, C_2, D_2$ and \bar{C}_2 . We know a priori the following :

- The branches $\bar{C}_1, \bar{C}'_1, C'_1 D'_1$ and \bar{C}_2 are semi-analytic. We must check if they end on the abnormal direction.
- The branches C_1, D_1, C_2 and D_2 are in the exp-log category and are ending on the abnormal direction.
- We must compare the positions of the branches C_1, D_1, C_2 and D_2 to determine which ones are in the sphere.

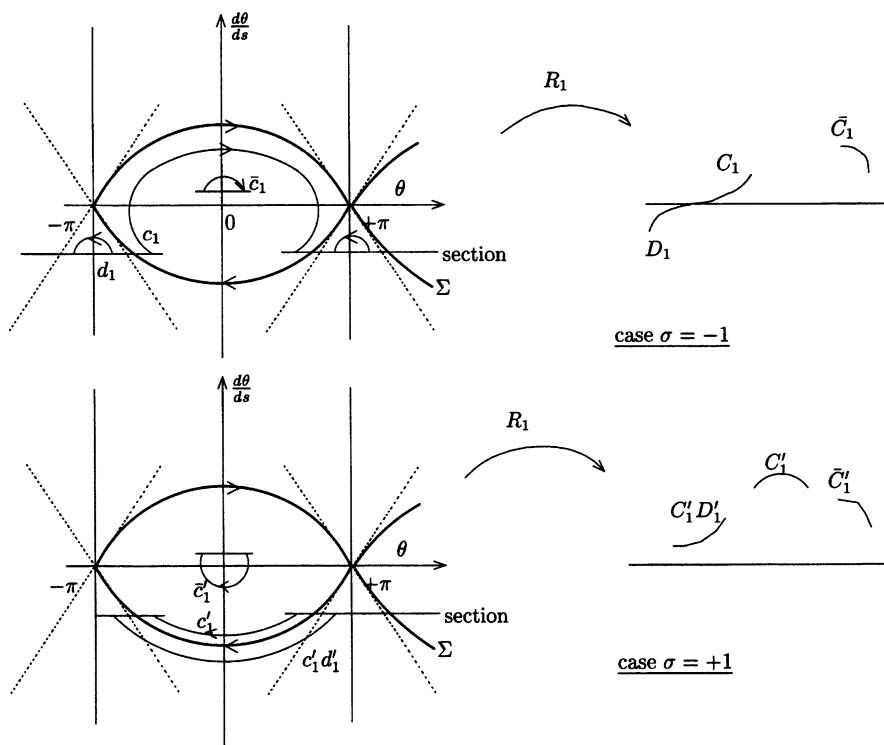

Figure 17

All the computations are made in the general integrable case, i.e. the coefficients of the metrics a and c are *analytic functions of y* so that :

$$a = 1 + 2\alpha y + \dots$$

$$c = 1 + 2\gamma y + \dots$$

Our computations are based on the integral formulas (35) and lead to the following :

PROPOSITION 4.12 (COMPARISON OF BRANCHES C_1, C_2, D_2). — Let $X = \frac{x+r}{2r}$ and $Z = \frac{z}{r^3}$. We have the estimates :

- branch C_1 : $Z = \frac{1}{6}X^3 + \left(\frac{r^2\alpha^2}{64} + \frac{\pi r}{32}(\alpha + \gamma) \right) X^4 + o(X^4)$
- branch C_2 : $Z = \frac{1}{24}X^3 + o(X^3)$
- branch D_2 : $Z = \frac{1}{6}X^3 + \left(\frac{r^2\alpha^2}{64} - \frac{\pi r}{32}(\alpha + \gamma) \right) X^4 + o(X^4)$

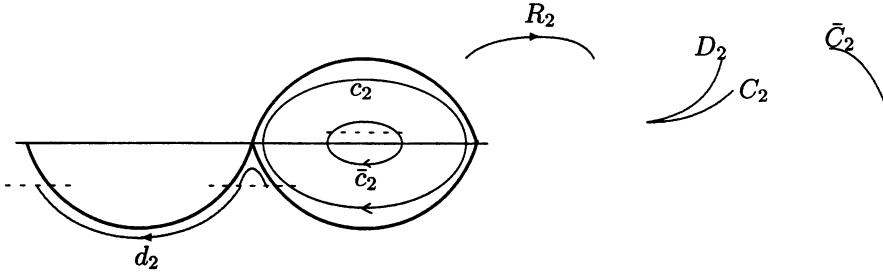

Figure 18. $-\sigma = \pm 1$

and we can conclude :

- if $\gamma > -\alpha$, the branch C_1 is in the sphere.
- if $\gamma < -\alpha$, the branch D_2 is in the sphere.

Remark 4.4. — At 0 the Gauss curvature of the Riemannian metric $g_R = adx^2 + cdy^2$ is $K = \frac{\alpha(\alpha+\gamma)+\beta^2}{4}$. If $\beta = 0$, it reduces to $\frac{\alpha(\alpha+\gamma)}{4}$. Hence the critical value $\alpha + \gamma = 0$ is connected to $K = 0$.

If $\alpha = 0$ in the gradated form of order 0, the section reduces to : $y = 0$. Then the branch D_1 does not exist (see Fig. 17) and the branch $\bar{C}_1 = \bar{C}'_1$ ends on the abnormal direction (and is in the sphere). Also the branches $C'_1 D'_1$ and \bar{C}_2 end on the abnormal direction, but are not in the sphere, as can easily be checked.

If $\alpha \neq 0$, the branches $\bar{C}_1, \bar{C}'_1, C'_1 D'_1$ and \bar{C}_2 do not end on the abnormal direction. A new branch appears : D_1 , which is the only branch in $z < 0$ that ends on $(-r, 0)$ (the same is available in $z > 0$ on $(r, 0)$). Therefore D_1 is in the sphere.

Hence we know the asymptotics of the trace of the sphere with $y = 0$ near the singularity $(-r, 0)$ (resp. $(r, 0)$) in the general integrable case. Now an important question is to check *in which class it is*. In [2] it was proved that the sphere in the flat case is *not subanalytic*. Very precise evaluations of flat terms of branch C_1 lead to the following :

THEOREM 4.13. — *In the general integrable case the sphere is not subanalytic.*

Remark 4.5. — This result cannot be obtained by perturbation of the flat case. The explanation is the following.

We proved that in the flat case the sphere is not subanalytic :

$$Z = \frac{1}{6}X^3 - 4X^3e^{-\frac{1}{X}} + o(X^3e^{-\frac{1}{X}})$$

In the general case (not only integrable) a natural idea would be to invoke some perturbation argument in order to check non subanalyticity. We may think that the previous graph is continuous with respect to the coefficients of the metrics, or with respect to the radius of the sphere. But this is wrong, as shown in the following example :

$$F_1 = (1 + \varepsilon y) \frac{\partial}{\partial x} + \frac{y^2}{2} \frac{\partial}{\partial z}, \quad F_2 = \frac{\partial}{\partial y}, \quad g = \frac{1}{(1 + \varepsilon y)^2} dx^2 + dy^2 \quad (\varepsilon < 0)$$

We obtain :

$$Z = \frac{1}{6}X^3 + \frac{r^2\varepsilon^2}{32}X^4 + \dots + r\varepsilon\left(\frac{3}{4} - \frac{7}{12}r^2\varepsilon^2\right)X^4e^{-\frac{1}{X}} + o(X^4e^{-\frac{1}{X}})$$

This is actually not surprising, since in the step of elimination of the parameter k' (see [14]), we replaced k' with its expression in function of X . But this step needs an exponentiation, and we know that equivalents do not pass through exponentiation.

However we could expect that the expansions of X and Z in function of $\frac{1}{\sqrt{\lambda}}, k'$ (see [14]) are continuous with respect to the coefficients. It is still wrong :

- flat case : $Z - \frac{1}{6}X^3 = -2\frac{k'^2}{\lambda^{3/2}} + o\left(\frac{k'^2}{\lambda^{3/2}}\right)$
- case $\varepsilon < 0$: $Z - \frac{1}{6}X^3 = \frac{1}{\lambda^2} \text{An}\left(\frac{1}{\sqrt{\lambda}}\right) - \left(3 + \frac{r^2\varepsilon^2}{4}\right)\frac{k'^2}{\lambda^{3/2}} + o\left(\frac{k'^2}{\lambda^{3/2}}\right)$

Nevertheless we can observe that *the analytic part of the graph is always continuous with respect to the coefficients*. Instability only appears in flat terms. This can be easily explained in the case $\varepsilon < 0$: to compute X and Z , we need to evaluate some integrals. To do that, the change of variable $\eta = \frac{k'}{k} \text{sh } t$ is relevant (see [14]) and leads to expand X and Z as a sum of terms containing $\text{Argsh } \frac{\varepsilon p_x}{2k'\sqrt{\lambda}}$. Now if one wants to expand this last expression (using the formula $\text{Argsh } x = \ln(x + \sqrt{1 + x^2})$), with $k'\sqrt{\lambda} \rightarrow 0$, it is necessary to assume ε fixed (so as r) to get :

$$\begin{aligned} \text{Argsh } \frac{\varepsilon p_x}{2k'\sqrt{\lambda}} &= \ln \frac{\varepsilon p_x}{2k'\sqrt{\lambda}} + \ln \left(1 + \sqrt{1 + \frac{4k'^2\lambda}{\varepsilon^2 p_x^2}} \right) \\ &= \ln \frac{\varepsilon p_x}{2k'\sqrt{\lambda}} + \ln 2 + \text{An} \left(\frac{k'^2\lambda}{\varepsilon^2 p_x^2} \right) \end{aligned}$$

in order to obtain analytic expansions of X and Z , which prove that the sphere belongs to the log-exp category. Unfortunately in this last expression, there is no sense to make $\varepsilon \rightarrow 0$ because we needed to assume ε fixed. Moreover note that $k'^2 \operatorname{sh} 2 \operatorname{Argsh} \frac{\varepsilon p_x}{2k'\sqrt{\lambda}} = \frac{\varepsilon^2 p_x^2}{2\lambda} + k'^2 + o(k'^2)$, so that this term brings new flat terms with coefficients having the same order as unity.

We could now expect to have continuity with respect to parameters if we do not expand the Argsh 's, and try to make the following reasoning :

1. $x \mapsto f(0, x)$ is not subanalytic.
2. $\varepsilon \mapsto f(\varepsilon, x)$ is continuous.

Then for $\varepsilon \neq 0$ $x \mapsto f(\varepsilon, x)$ is not subanalytic.

But this is wrong, see the following example :

$$f(\varepsilon, t) = \ln t + \operatorname{Argsh} \frac{\varepsilon}{t} = \ln 2\varepsilon + \frac{t^2}{2\varepsilon^2} + \dots \quad : \text{analytic in } t.$$

$$f(0, t) = \ln t \quad : \text{not subanalytic.}$$

So the sphere is not subanalytic. Now the main question is : in which category is the sphere ? In [14], we proved that the branch C_1 belongs to the log-exp category. A precise answer is the following :

PROPOSITION 4.14. — *We set near the singularity $(-r, 0)$: $X = \frac{x+r}{2r}$, $Z = \frac{z}{r^3}$, and we have :*

- *branch C_1 : $Z = \operatorname{An}(X, X \ln X, X \ln^2 X, X \ln^3 X, \frac{e^{-\frac{1}{X^3}}}{X^3}) = \frac{1}{6} X^3 + \dots$ where $\operatorname{An}(\cdot)$ is a germ at 0 of an analytic function. Moreover the analytic part of $Z(X)$ is continuous with respect to r and the coefficients of the metrics.*
A similar result holds for D_2 .
- *branch D_1 : $Z = \operatorname{An}(\sqrt{-X}, \sqrt{-X} \ln(-X), e^{-\frac{r\alpha}{2\sqrt{2}\sqrt{-X}}}) = \frac{-8}{r^2\alpha^2} X^2 + \dots$ Moreover the analytic part of $X(\sqrt{Z})$ is continuous with respect to r and the coefficients of the metrics.*

COROLLARY 4.15. — *In the general integrable Martinet case the sphere belongs to the log-exp category.*

Proof. — Our estimations show that near the abnormal direction the sphere is log-exp. In the other directions the sphere is subanalytic, see [1]. \square

4.2.13. Asymptotics of the sphere and wave front in the abnormal direction in the general gradated case of order 0

We set : $g = (1 + \alpha y)^2 dx^2 + (1 + \beta x + \gamma y)^2 dy^2$ with $\alpha, \beta \neq 0$. In this case the equation in $(\theta, \dot{\theta})$ obtained by projection is not integrable. In order to compute the asymptotics of the sphere we can use *formal first integrals* near the saddles. Moreover toric blowing-up allow us to evaluate the solution if λ is fixed, see [15, 16]. The technics are similar to the ones used by [38] and others to evaluate the Poincaré-Dulac return mapping near a polycycle for a one-parameter family (X_ε) of vector fields. This computation can be reduced to the evaluation of the Poincaré-Dulac mapping *near a resonant saddle* :

$$X_\varepsilon = \lambda_1(\varepsilon) \frac{\partial}{\partial x'} + \lambda_2(\varepsilon) \frac{\partial}{\partial y'}$$

$$r = \frac{\lambda_1(\varepsilon)}{\lambda_2(\varepsilon)} \quad \lambda_1 \lambda_2 < 0$$

$$r(0) = -1 \quad r = -1 + \alpha_1(\varepsilon)$$

In this method we use a normal form in which :

- the separatrices are normalized to : $x' = 0, y' = 0$.
- $X_\varepsilon \sim x' \frac{\partial}{\partial x'} - y' \frac{\partial}{\partial y'} - \left(\sum_{i=0}^N \alpha_{i+1}(\varepsilon) (x' y')^i \right) y' \frac{\partial}{\partial y'}$

up to a change of time parametrization, and in some neighborhood $U \times \mathcal{E}(\varepsilon) \subset \mathbb{R}^2 \times \mathbb{R}$, with $\mathcal{E}(\varepsilon) \xrightarrow{\varepsilon \rightarrow 0} 0$, see [38] for details.

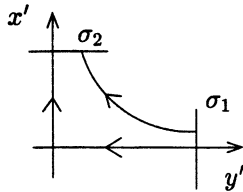

In our case the method has to be *adapted*. Indeed in our case the section depends on the parameter and is imposed by the geometry. In particular the distance of the saddle point to the section σ_ε tends to 0 when $\varepsilon \rightarrow 0$. The method is the following. Let d be the distance to the separatrix. Then we want to compute : $d \mapsto (x(d) + r, z(d))$ when $d \approx 0$ (using the normal form for $(X_\varepsilon, \sigma_\varepsilon)$).

This computation generalizes the computation in the conservative case where d is the distance to the root of multiplicity two of the potential.

The algorithm to evaluate step by step this application is to consider the k -jet of $(X_\varepsilon, \sigma_\varepsilon)$. It is not clear a priori that the k -jet is sufficient to compute the first k terms in the expansion. However we shall prove that the 1-jet is sufficient to compute the first term in the expansion. It gives us the contact of the branch D_1 with the abnormal direction.

PROPOSITION 4.16. — *Let us suppose $a = (1 + \alpha y)^2$, $c = (1 + \beta x + \gamma y)^2$ with $\alpha > 0$. Let $X = \frac{x+r}{2r}$, $Z = \frac{z}{r^3}$. Then near $X = 0$ the graph of the branch D_1 is the following :*

$$Z = \frac{-2}{r^2 \alpha^2} X^2 + o(X^2)$$

Remark 4.6. — Observe that in the flat case, the abnormal geodesic is not strict and the contact is of order 1 (see prop 4.10).

Proof. — The differential system is :

$$\begin{aligned} \frac{dx}{dt} &= \frac{\cos \theta}{1 + \alpha y}, & \frac{dy}{dt} &= \frac{\sin \theta}{1 + \beta x + \gamma y}, & \frac{dz}{dt} &= \frac{y^2 \cos \theta}{2(1 + \alpha y)} \\ \frac{d\theta}{dt} &= -\frac{1}{(1 + \alpha y)(1 + \beta x + \gamma y)} (\lambda y - \alpha \cos \theta + \beta \sin \theta) \end{aligned}$$

Reparametrizing with : $ds = \sqrt{\lambda} \frac{1}{(1 + \alpha y)(1 + \beta x + \gamma y)} dt$, we obtain :

$$\begin{aligned} \frac{dx}{ds} &= \frac{1}{\sqrt{\lambda}} (1 + \beta x + \gamma y) \cos \theta \\ \frac{dy}{ds} &= \frac{1}{\sqrt{\lambda}} (1 + \alpha y) \sin \theta \\ \frac{dz}{ds} &= \frac{1}{\sqrt{\lambda}} \frac{y^2}{2} (1 + \beta x + \gamma y) \cos \theta \\ \frac{d\theta}{ds} &= -\sqrt{\lambda} y + \frac{\alpha}{\sqrt{\lambda}} \cos \theta - \frac{\beta}{\sqrt{\lambda}} \sin \theta \end{aligned} \tag{39}$$

Hence the equation governing θ is :

$$\frac{d^2 \theta}{ds^2} + \sin \theta + \frac{\alpha^2}{\lambda} \sin \theta \cos \theta - \frac{\alpha \beta}{\lambda} \sin^2 \theta + \frac{\beta}{\sqrt{\lambda}} \cos \theta \frac{d\theta}{ds} = 0$$

Set $u = \theta + \pi$, $v = \frac{d\theta}{ds}$. Then :

$$\begin{aligned} \frac{du}{ds} &= v \\ \frac{dv}{ds} &= \sin u - \frac{\alpha^2}{\lambda} \sin u \cos u + \frac{\alpha \beta}{\lambda} \sin^2 u + \frac{\beta}{\sqrt{\lambda}} v \cos u \end{aligned}$$

The eigenvalues of the linearized system are solutions of : $\mu^2 - \frac{\beta}{\sqrt{\lambda}}\mu - (1 - \frac{\alpha^2}{\lambda}) = 0$, hence : $\mu_1 = 1 + \frac{\beta}{2\sqrt{\lambda}} + O\left(\frac{1}{\lambda}\right)$, $\mu_2 = -1 + \frac{\beta}{2\sqrt{\lambda}} + O\left(\frac{1}{\lambda}\right)$.

Let $u = u_1 + v_1, v = \mu_1 u_1 + \mu_2 u_2$. We get :

$$\begin{aligned} \frac{du_1}{ds} &= \mu_1 u_1 + O\left(\frac{u_1^2}{\lambda}, \frac{v_1^2}{\lambda}, \frac{u_1 v_1}{\lambda}, \frac{u_1^3}{\sqrt{\lambda}}, \frac{u_1^2 v_1}{\sqrt{\lambda}}, \frac{u_1 v_1^2}{\sqrt{\lambda}}, \frac{v_1^3}{\sqrt{\lambda}}\right) \\ \frac{dv_1}{ds} &= \mu_2 v_1 + O\left(\frac{u_1^2}{\lambda}, \frac{v_1^2}{\lambda}, \frac{u_1 v_1}{\lambda}, \frac{u_1^3}{\sqrt{\lambda}}, \frac{u_1^2 v_1}{\sqrt{\lambda}}, \frac{u_1 v_1^2}{\sqrt{\lambda}}, \frac{v_1^3}{\sqrt{\lambda}}\right) \end{aligned}$$

and after integration :

$$\begin{aligned} u(s) &= Ae^{\mu_1 s} + Be^{\mu_2 s} + O\left(\frac{A^2}{\lambda}e^{2\mu_1 s}, \frac{B^2}{\lambda}e^{2\mu_2 s}, \frac{AB}{\lambda}e^{(\mu_1+\mu_2)s}, \frac{A^3}{\sqrt{\lambda}}e^{3\mu_1 s}, \right. \\ &\quad \left. A^2 B e^{(2\mu_1+\mu_2)s}, AB^2 e^{(\mu_1+2\mu_2)s}, \frac{B^3}{\sqrt{\lambda}}e^{3\mu_2 s}\right) \\ v(s) &= \mu_1 A e^{\mu_1 s} + \mu_2 B e^{\mu_2 s} + O(\dots) \end{aligned}$$

where A and B are constants to determine.

The section is $y = 0$, hence : $v = \frac{-\alpha}{\sqrt{\lambda}} \cos u + \frac{\beta}{\sqrt{\lambda}} \sin u = \frac{-\alpha}{\sqrt{\lambda}} + \frac{\beta}{\sqrt{\lambda}} u + O\left(\frac{u^2}{\sqrt{\lambda}}\right)$ Let s_f be the parameter corresponding to the final time $t = r$, i.e. : $y(0) = y(s_f) = 0$. Putting these conditions in the previous equations we obtain :

$$B = \frac{\alpha}{\sqrt{\lambda}} + O\left(\frac{1}{\lambda}\right) , \quad A = \frac{-\alpha}{\sqrt{\lambda}} e^{-\mu_1 s_f} + O\left(\frac{1}{\lambda} e^{-\mu_1 s_f}\right)$$

Hence :

$$\theta(s) + \pi = u(s) = \frac{-\alpha}{\sqrt{\lambda}} e^{\mu_1(s-s_f)} + \frac{\alpha}{\sqrt{\lambda}} e^{\mu_2 s} + O\left(\frac{1}{\lambda} e^{\mu_1(s-s_f)}, \frac{1}{\lambda} e^{\mu_2 s}\right) \quad (40)$$

To get y , just note that : $y = -\frac{1}{\sqrt{\lambda}} \frac{d\theta}{ds} + \frac{\alpha}{\lambda} \cos \theta - \frac{\beta}{\sqrt{\lambda}} \sin \theta$, hence :

$$y(s) = -\frac{\alpha}{\lambda} + \frac{\alpha}{\lambda} e^{\mu_1(s-s_f)} + \frac{\alpha}{\lambda} e^{\mu_2 s} + O\left(\frac{1}{\lambda^{3/2}}\right) \quad (41)$$

Then we have to compute x , which amounts to integrating equation (39). We get :

$$1 + \beta x(s) = e^{-\frac{\beta}{\sqrt{\lambda}} s} + \frac{\alpha\gamma}{\lambda} - \frac{\alpha\gamma}{\lambda} e^{-\frac{\beta}{\sqrt{\lambda}} s} + O\left(\frac{1}{\lambda^{3/2}}\right) \quad (42)$$

The computation of z is then similar and we obtain :

$$z(s) = -\frac{\alpha^2}{2\lambda^2} \frac{1 - e^{-\frac{\beta}{\sqrt{\lambda}}s}}{\beta} + o\left(\frac{1}{\lambda^2}\right) \quad (43)$$

It remains to estimate s_f . From the equation : $\frac{dt}{ds} = \frac{1}{\sqrt{\lambda}}(1 + \alpha y)(1 + \beta x + \gamma y)$ we get :

$$r = \frac{1 - e^{-\frac{\beta}{\sqrt{\lambda}}s_f}}{\beta} \left(1 - \alpha \frac{\alpha + \gamma}{\lambda}\right) + O\left(\frac{1}{\lambda^{3/2}}\right) \quad (44)$$

This leads to the conclusion : $Z = \frac{-2}{r^2\alpha^2}X^2 + o(X^2)$

□

Remark 4.7. — Another way to compute this expansion is to use the theory developed in [42], which states that the so-called L^∞ -sector has a contact of order 2 with the abnormal direction, and moreover gives an explicit formula to estimate the contact.

The previous method cannot be applied to study the contact of branches C_1 and D_2 with the abnormal direction, because in the phase plane of the pendulum these branches correspond to a *global computation of return mapping*, and thus the calculations cannot be localized near a saddle as previously. Anyway inspecting carefully the system leads to the following :

LEMMA 4.17. — *In the general gradated case of order 0 the contact of branches C_1 and D_2 with the abnormal direction is :*

$$Z = \left(\frac{1}{6} + O(r)\right)X^3 + o(X^3)$$

Note that contacts are still in the polynomial category.

Proof. — We have : $\dot{y} = v/\sqrt{c}$, hence $\|y\|_\infty = O(r)$. On the other part : $\dot{x} = u/(1 + \alpha y)$, and thus : $\dot{x} = u(1 + O(r))$. In the same way : $\dot{z} = u\frac{y^2}{2}(1 + O(r))$. Then the result in the flat case leads easily to the conclusion. □

Remark 4.8. — From our previous study we can assert that minimizing controls steering 0 to points of C_1 (resp. D_2) are close to the abnormal reference control in L^2 -topology, but not in L^∞ -topology. It is a crucial difference with the branch D_1 .

Concerning the *transcendence* of this branch D_1 , the following fact was proved in [43] :

PROPOSITION 4.18. — *In the general graded case of order 0, if $\alpha \neq 0$ then the branch D_1 is C^∞ and is not subanalytic at $x = -r, z = 0$.*

COROLLARY 4.19. — *In the general graded case of order 0, if the abnormal minimizer is strict then the SR spheres with small radii are not subanalytic.*

Proof. — Let $A = (-r, 0, 0)$ denote the end-point of the abnormal trajectory. We shall prove that D_1 is not subanalytic at A . The method is the following. First of all the Maximum Principle gives a parametrization of minimizing trajectories steering 0 to points of D_1 . Then we prove that the set of Lagrange multipliers associated to these points (i.e. end-points of the corresponding adjoint vectors) is not subanalytic. Finally we conclude using the fact that, roughly speaking, these vectors coincide with the gradient of the sub-Riemannian distance (where it is well-defined). These facts are summarized in the following :

LEMMA 4.20. — *To each point q of D_1 is associated a control u , and we denote by $(\psi(q), \psi^0(q))$ an associated Lagrange multiplier. Then we set :*

$$\mathcal{L} = \left\{ \left(\frac{\psi_x(q)}{\sqrt{\psi_x(q)^2 + \psi_z(q)^2}}, \frac{\psi_z(q)}{\sqrt{\psi_x(q)^2 + \psi_z(q)^2}} \right) / q \in D_1 \right\}$$

where ψ_x (resp. ψ_z) is the projection on the axis x (resp. on the axis z) of the vector ψ . If the set \mathcal{L} is not subanalytic then the curve D_1 is not subanalytic.

Proof of the Lemma. — Let $(q(\tau))_{0 \leq \tau < 1}$ be a parametrization of the curve D_1 such that $q(0) = A$. For each τ let u_τ be a control such that $E(u_\tau) = q(\tau)$, and let (ψ_τ, ψ_τ^0) be an associated Lagrange multiplier, i.e. :

$$\psi_\tau \cdot dE(u_\tau) = -\psi_\tau^0 dC(u_\tau)$$

Then : $\psi_\tau \cdot \frac{d}{d\tau} q(\tau) = \psi_\tau \cdot dE(u_\tau) \cdot \frac{d}{d\tau} u_\tau = -\psi_\tau^0 dC(u_\tau) \cdot \frac{d}{d\tau} u_\tau = -\psi_\tau^0 \frac{d}{d\tau} C(u_\tau)$. Moreover for each τ the point $q(\tau)$ belongs to the sphere $S(0, r)$, hence $C(u_\tau) = r$, and thus : $\psi_\tau \cdot \frac{d}{d\tau} q(\tau) = 0$. Therefore in the plane $(y = 0)$ the vectors of the set \mathcal{L} are unitary normal vectors to the curve D_1 . Then the conclusion is immediate. \square

With notations of Proof of Proposition 4.16, we are now lead to study a family of vector fields (X_ε) depending on the parameter $\varepsilon = \frac{1}{\sqrt{\lambda}}$, in the neighborhood of a saddle point $u = v = 0$. For the section Σ corresponding to $y = 0$ we estimate the *return time*, i.e. the time needed to a trajectory starting from Σ to reach again Σ ; then we claim that this time is $t = r$. This gives us a relation between $\theta(r)$ and λ , thus between $p_x(r)$ and $p_z(r)$.

Then one has to show that this relation is not subanalytic. We proceed in the following way. First of all recall that

$$1 + \beta x(s) = e^{-\frac{\beta}{\sqrt{\lambda}}s} + O\left(\frac{1}{\lambda}\right), \quad y(s) = O\left(\frac{1}{\lambda}\right)$$

We need a result which is independant of the parameter $\varepsilon = \frac{1}{\sqrt{\lambda}}$. So it is no use trying to write an analytic normal form, since the saddle may be resonant. On the other hand C^k normal forms (see [38]) are not enough because flat terms that we aim to exhibit disappear up to a $O(\varepsilon^k)$. However near the saddle separatrices of X_ε are analytic in u, v, ε , and actually there exists an analytic change of coordinates $(u_1, v_1) = An(u, v)$ (in the sequel $An(\cdot)$ denotes an analytic germ at 0) such that in these new coordinates separatrices are $u_1 = 0, v_1 = 0$, and the system is :

$$\dot{u}_1 = \mu_1\left(\frac{1}{\sqrt{\lambda}}\right)u_1\left(1 + o\left(\frac{1}{\sqrt{\lambda}}\right)\right), \quad \dot{v}_1 = \mu_2\left(\frac{1}{\sqrt{\lambda}}\right)v_1\left(1 + o\left(\frac{1}{\sqrt{\lambda}}\right)\right)$$

where $\mu_1\left(\frac{1}{\sqrt{\lambda}}\right), \mu_2\left(\frac{1}{\sqrt{\lambda}}\right)$ are the eigenvalues of the saddle ; in particular : $\mu_2\left(\frac{1}{\sqrt{\lambda}}\right) = -1 + \frac{\beta}{2\sqrt{\lambda}} + O\left(\frac{1}{\lambda}\right)$. Moreover we have : $u = u_1 + v_1 + o\left(\frac{1}{\sqrt{\lambda}}\right), v = u_1 - v_1 + o\left(\frac{1}{\sqrt{\lambda}}\right)$, therefore the section is $\Sigma : v_1 = u_1 + \frac{\alpha}{\sqrt{\lambda}} + o\left(\frac{1}{\sqrt{\lambda}}\right)$. Let s_f denote the parameter corresponding to the return time, i.e. $(u_1(s_f), v_1(s_f)) \in \Sigma$. We have : $v_1(0) = \frac{1}{\sqrt{\lambda}} + o\left(\frac{1}{\sqrt{\lambda}}\right)$. Then :

$$s_f = \int_0^{s_f} ds = \int_{v_1(0)}^{v_1(s_f)} \frac{dv_1}{\mu_2\left(\frac{1}{\sqrt{\lambda}}\right)v_1\left(1 + o\left(\frac{1}{\sqrt{\lambda}}\right)\right)} = \frac{1}{\mu_2\left(\frac{1}{\sqrt{\lambda}}\right)} \ln \frac{v_1(s_f)}{v_1(0)} \quad (45)$$

On the other part : $\frac{dt}{ds} = \frac{1}{\sqrt{\lambda}}(1 + \alpha y)(1 + \beta x + \gamma y) = \frac{1}{\sqrt{\lambda}}e^{-\frac{\beta}{\sqrt{\lambda}}s} + O\left(\frac{1}{\lambda^{3/2}}\right)$. Hence we get :

$$r = \int_0^{s_f} \frac{dt}{ds} ds = \frac{1 - e^{-\frac{\beta}{\sqrt{\lambda}}s_f}}{\beta r} + O\left(\frac{1}{\lambda}\right)$$

And thus : $s_f = -\sqrt{\lambda} \frac{\ln(1 - \beta r)}{\beta} + O\left(\frac{1}{\sqrt{\lambda}}\right)$. Putting into (45) we obtain finally :

$$v_1(s_f) \sim \frac{1}{\sqrt{1 - \beta r}} \frac{1}{\sqrt{\lambda}} e^{\sqrt{\lambda} \frac{\ln(1 - \beta r)}{\beta}}$$

In particular $v_1(s_f)$ is not an analytic function in $\frac{1}{\sqrt{\lambda}}$.

We know that $v_1(s_f) = An(u(s_f), v(s_f)) \sim \frac{u(s_f) - v(s_f)}{2}$. Moreover, on the section Σ , we have : $v(s_f) = -\frac{\alpha}{\sqrt{\lambda}} \cos u(s_f) + \frac{\beta}{\sqrt{\lambda}} \sin u(s_f)$. Hence :

$v_1(s_f) = An(u(s_f), \frac{1}{\sqrt{\lambda}}) = \frac{u(s_f)}{2} + \dots$. From the Implicit Function Theorem in the analytic class we get : $u(s_f) = An(v_1(s_f), \frac{1}{\sqrt{\lambda}})$. Therefore $u(s_f)$ is not an analytic function in $\frac{1}{\sqrt{\lambda}}$. So the set \mathcal{L} is not subanalytic, which ends the proof. \square

Unfortunately we have no general result similar to Corollary 4.15. We think that the log-exp category is not wide enough in the non integrable case. Indeed due to the dissipation phenomenon observed in the pendulum representation if $\beta \neq 0$ we cannot expect to keep the analytic properties required in the definition of log-exp functions. Moreover in the phase plane of the pendulum, the foliation is not a priori integrable in the analytic category for any value of the parameter. We can observe that if we fix λ to 1 and evaluate the Poincaré-Dulac mapping, it is pfaffian if and only if X_ϵ ($\lambda = 1$) is C^ω -integrable (see [34, 35]).

Hence we conjecture :

CONJECTURE 4.21. — If $\beta \neq 0$ then SR Martinet spheres are not log-exp, even not pfaffian.

Hence we should try to extend the log-exp category to a wider category in which analyticity would be replaced with some asymptotic properties. That is why we should be interested in *Il'Yashenko's class of functions* (see [22]). Indeed several years ago the Dulac's problem of finiteness of limit cycles was solved independantly by Ecalle and Il'Yashenko ; in his proof, Il'Yashenko introduces a very wide class of *non-oscillating functions* to describe Poincaré return mappings. Actually he needs to expand real germs of functions into terms having not only the order of x^n but also into flat terms. His category is constructed by recurrence as follows. Let M_0 be a class of functions that can be expanded in an unique way into an ordinary Dulac's series, i.e. series of the form :

$$\Sigma_0 = cx^{\nu_0} + \sum_{i=1}^{\infty} P_i(\ln x)x^{\nu_i}$$

where $c > 0$, the P_i 's are polynomial and (ν_i) is an increasing sequence of positive numbers going to infinity. We only sketch the first step of the recurrence. By definition germs of the class M_1 can be expanded in series containing flat exponential terms whose coefficients belong to M_0 . For instance a super-accurate series of some germ f may be of the form :

$$\Sigma_1 = a_0(x) + \sum_{i=1}^{\infty} a_i(x)e^{-\frac{\nu_i}{x}}$$

where $a_i \in M_0$ and (ν_i) is an increasing sequence of positive numbers tending to infinity. It is a generalization of ordinary series in so much as the usual Dulac's series of f is $a_0(x)$.

The complete definition of super-accurate series then goes by recurrence (see [22]). Their interest is all in the fact that the application $f \mapsto \hat{f}$ is *one-to-one*, where \hat{f} is the super-accurate series associated to f .

The relation with our problem is the following. We deal actually with Poincaré return mappings in the phase plane of the pendulum, and their study is crucial to estimate the spheres. The difference is that our pendulum depends on parameters (namely λ) ; hence our problem is related to Dulac's problem with parameters, i.e. the Hilbert's 16th problem.

Hence we should try to construct a category of functions similar to the one introduced by Il'Yashenko, but with parameters. In any case it is a possible way to try to solve the problem of transcendence in SR geometry.

CONJECTURE 4.22. — In the general non integrable case SR spheres belong to some extended Il'Yashenko's category.

4.2.14. Conjecture about the cut-locus : the Martinet sphere in the Liu-Sussmann example

We shall construct the cut-locus in the Liu-Sussmann example [29], the reasoning being generalizable to compute the generic SR-Martinet sphere. The model is the following :

$$D = \text{Ker } \omega , \quad \omega = (1 + \varepsilon y)dz - \frac{y^2}{2}dx , \quad g = \frac{dx^2}{(1 + \varepsilon y)^2} + dy^2$$

The model is non generic because it is conservative ; moreover the Lie algebra generated by the orthonormal frame is nilpotent. In the cylindric coordinates the geodesics equations are :

$$\begin{aligned} \dot{x} &= (1 + \varepsilon y) \cos \theta , & \dot{y} &= \sin \theta , & \dot{z} &= \frac{y^2}{2} \cos \theta \\ \dot{\theta} &= -(p_x \varepsilon + p_z y) , & P_3 &= \lambda \end{aligned}$$

and the angle evolution is the pendulum : $\ddot{\theta} + \lambda \sin \theta = 0$ if $\lambda \neq 0$. Using the symmetry : $(x, y, z) \mapsto (-x, y, -z)$ we can assume $\lambda > 0$. The abnormal geodesic starting from 0 : $t \mapsto (\pm t, 0, 0)$, is strict if and only if $\varepsilon \neq 0$. We may assume $\varepsilon \leq 0$. Introducing $s = t\sqrt{\lambda}$, and denoting by ' the derivative with respect to s , the pendulum is normalized to : $\dot{\theta} + \sin \theta = 0$. The

constraint $y = 0$ defines the section $\Sigma : \dot{\theta} = -p_x \varepsilon$, which can be written : $\theta' = -\frac{\varepsilon \cos \theta}{\sqrt{\lambda}}$.

The geodesics corresponding to $\lambda = 0$ are globally optimal if the length r is small enough. They divide the sphere $S(0, r)$ into two hemispheres and we compute the cut-locus in the northern hemisphere ($\lambda > 0$).

If $\varepsilon = 0$, the SR-sphere is the Martinet flat sphere. The abnormal line is not strict and cuts the equator $\lambda = 0$ in two points. The cut-locus is the plane $y = 0$ minus the abnormal line, in which, due to the symmetry $(x, y, z) \mapsto (x, -y, z)$, two normal geodesics are intersecting with the same length. It is represented on Fig. 19.

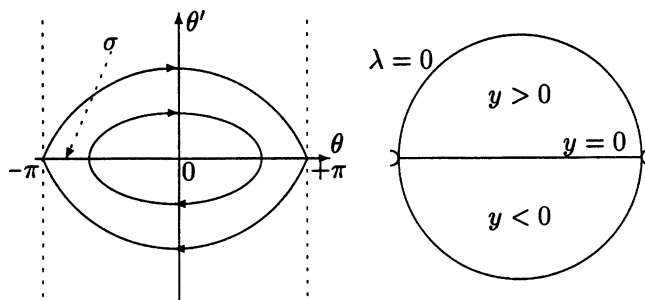

Figure 19

When $\varepsilon \neq 0$, the section and the pendulum are represented on Fig. 20.

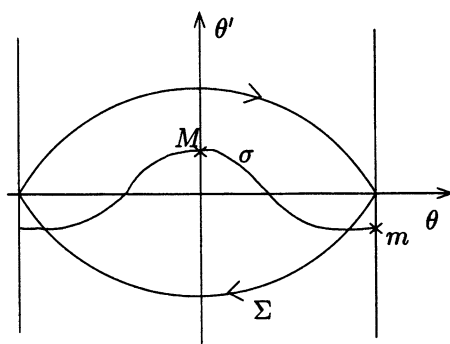

Figure 20

σ is given by $\theta' = -\frac{\varepsilon \cos \theta}{\sqrt{\lambda}}$. When $\lambda \rightarrow +\infty$, the section tends to $\theta' = 0$, and when $\lambda \rightarrow 0$ the points M and m tend to ∞ .

We can easily construct the cut-locus on the small sphere using the following conjectures :

- Only the geodesics where the section σ is in the configuration of Fig. 20 have cut-points (this is justified by the fact that when $\lambda = 0$ the geodesics are globally optimal if the length is small enough).
- A separatrix has no cut-point.

The trace of the sphere with the Martinet plane has been computed in [10]. An important property is that the rotating trajectories of the pendulum near the separatrix have a cut-point located in the plane $y = 0$, corresponding to its second intersection with $y = 0$. We represent on Fig. 21 the construction of the cut-locus.

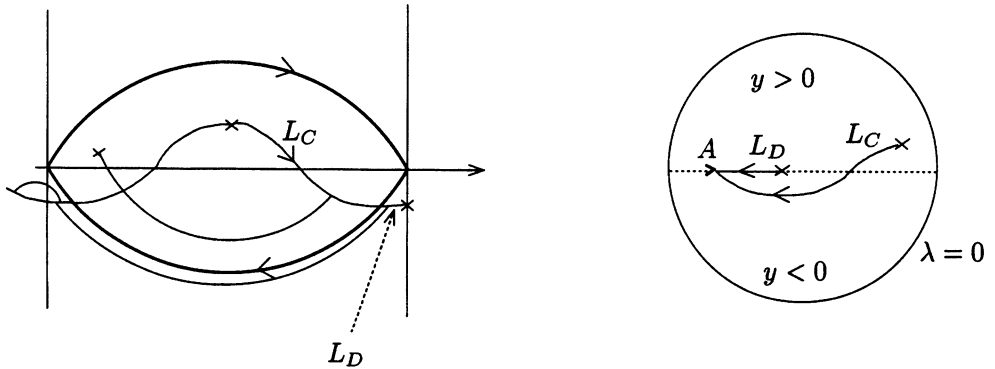

Figure 21

The cut-locus has two branches L_C and L_D corresponding respectively to oscillating and rotating trajectories. They ramify on the abnormal direction A which is not contained in the cut-locus. The extremities of the branches L_C and L_D are conjugate points corresponding respectively to $\theta(0) = \pi$ and $\theta(0) = 0$. The branch L_C has only one intersection with $y = 0$ which corresponds approximatively to $\theta(0) = \frac{\pi}{2}$. *The cut-locus is not subanalytic at A but belongs to the log-exp category*, and thus from [20] :

LEMMA 4.23. — *The cut-locus is C^∞ -stratifiable.*

To generalize this analysis we must observe the following. The respective positions of the branches C_1, D_2 are given in Section 4.2. Here the curve D_2 is above and hence the rotating trajectories are optimal up to the second intersection. Also the integrability of the geodesic flow is not crucial and in

general the branch L_D is not contained in the plane $y = 0$. We make the following conjecture.

- CONJECTURE 4.24. 1. In the Martinet case the cut-locus is C^1 -stratifiable.
2. In the generic case the cut-locus has two branches in the northern hemisphere ramifying at the end-point of the abnormal direction.

5. Some extensions of Martinet SR geometry and microlocal analysis of the singularity of the SR sphere in the abnormal direction

5.1. Non properness and Tangency Theorem

This analysis is based on the sub-Riemannian Martinet case, where it was shown in the previous Section that the exponential mapping is not proper and that in the generic case the sphere is tangent to the abnormal direction. This fact is actually general and we have the following results (see [40]).

Consider a smooth sub-Riemannian structure (M, Δ, g) where M is a Riemannian n -dimensional manifold, $n \geq 3$, Δ is a rank m distribution on M , and g is a metric on Δ . Let $q_0 \in M$; our point of view is local and we can assume that $M = \mathbb{R}^n$ and $q_0 = 0$. Suppose there exists a strict (in the sense of definition 3.2) abnormal trajectory γ passing through 0. Up to reparametrizing we can assume that $\Delta = \text{Span} \{F_1, \dots, F_m\}$ where the system of F_i 's is g -orthonormal. Then the sub-Riemannian problem is equivalent to the *time-optimal problem* for the system :

$$\dot{q} = \sum_{i=1}^m u_i F_i(q), \quad q(0) = 0 \tag{46}$$

where the controls satisfy the *constraint* $\sum_{i=1}^m u_i^2 \leq 1$. Suppose further that γ is associated to an unique strictly abnormal control. Then :

THEOREM 5.1. — *The exponential mapping is not proper near γ .*

Proof. — Set $A = \gamma(r), r > 0$. Let (A_n) be a sequence of end-points of minimizing normal geodesics q_n converging to A . To each geodesic q_n is associated a control u_n and an adjoint vector (p_n, p_n^0) . As q_n is normal we may suppose that $p_n^0 = -\frac{1}{2}$. Let ψ_n the end-point of the adjoint vector p_n . Then if E denotes the end-point mapping and C is the cost (here the

cost is quadratic in the control), we have the following *Lagrange multiplier equality* :

$$\psi_n.dE(u_n) = \frac{1}{2}dC(u_n)$$

If the sequence ψ_n were bounded then up to a subsequence it would converge to some $\psi \in \mathbb{R}^n$. Now since the u_n are minimizing the sequence (u_n) is bounded in L^2 , hence up to a subsequence it converges weakly to some $u \in L^2$. Using the regularity properties of the end-point mapping (see [40]), we can pass through the limit in the previous equality and we get :

$$\psi.dE(u) = \frac{1}{2}dC(u)$$

and on the other part : $A = E(u)$. It is not difficult to see that u has to be minimizing, and then we get a contradiction with the fact that γ is strict. \square

Remark 5.1. — Conversely if the exponential mapping is not proper then actually there exists an abnormal minimizer. This shows the interaction between abnormal and normal minimizers. In a sense normal extremals recognize abnormal extremals. This phenomenon of non-properness is characteristic for abnormality.

This non-properness is actually responsible for a phenomenon of *tangency* described in the following Theorem (see [42] for a more general statement):

THEOREM 5.2. — *Consider the SR system (46) and suppose there exists a minimizing geodesic γ associated to an unique strictly abnormal control u . Let $A \in S(0, r)$ be the end-point of γ . Assume $(\sigma(\tau))_{0 < \tau \leq 1}$ is a C^1 curve on $S(0, r)$ such that $\lim_{\tau \rightarrow 0} \sigma(\tau) = A$. Then : $\lim_{\tau \rightarrow 0} \sigma'(\tau) \in \text{Im } dE(u)$.*

In particular if $S(0, r)$ is C^1 -stratifiable near A then the strata of $S(0, r)$ are tangent at A to the hyperplane $\text{Im } dE(u)$ (see Fig. 22). Moreover if B is a C^1 -branch of the cut-locus ramifying at A then B is tangent at A to this hyperplane.

Proof. — For each τ the point $\sigma(\tau)$ is the end-point of a minimizing geodesic, and we denote by (p_τ, p_τ^0) (resp. u_τ) an associated adjoint vector (resp. an associated control). Let (ψ_τ, ψ_τ^0) be the end-point of this adjoint vector. We may suppose that it is unitary in $\mathbb{R}^n \times \mathbb{R}$. We have :

$$\psi_\tau.dE(u_\tau) = -\psi_\tau^0 dC(u_\tau)$$

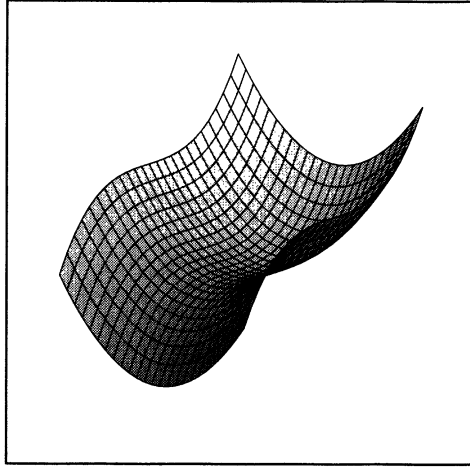

Figure 22. – Tangency phenomenon

Using the same reasoning as in the Proof of Theorem 5.1 we get that $\|\psi_\tau^0\| \rightarrow 0$ as $\tau \rightarrow 0$. To conclude it suffices to show that ψ_τ is normal to the curve $\sigma(\tau)$. Indeed the previous equality implies :

$$\psi_\tau \cdot dE(u_\tau) \cdot \frac{du_\tau}{d\tau} = -\psi_\tau^0 dC(u_\tau) \cdot \frac{du_\tau}{d\tau}$$

But $C(u_\tau)$ is constant (equal to r) and $E(u_\tau) = \sigma(u_\tau)$, and thus :

$$\psi_\tau \cdot \frac{d\sigma(\tau)}{d\tau} = 0$$

which ends the proof. □

5.2. The tangential case

5.2.1. Preliminaries

In this Subsection we shall make a brief analysis of the so-called tangential case. According to Section 2.2.2 the distribution $D = \text{Ker } \omega$ can be reduced [45] to one of the normal forms :

- elliptic case : $\omega_e = dy - (\varepsilon xy + \frac{x^3}{3} + xz^2 + mx^3z^2)dz$
- hyperbolic case : $\omega_h = dy - (\varepsilon xy + x^2z + mx^3z^2)dz$

where $\varepsilon = \pm 1$. The parameter ε is a deformation parameter whose introduction will be justified later.

A general metric g is then defined by : $a(q)dx^2 + 2b(q)dx dz + c(q)dz^2$ where a, b, c can be taken as constant in the nilpotent approximation of order -1 . Our study is far to be complete and we shall describe briefly the case $g = dx^2 + dz^2$.

The general case of order -1 depends on a parameter λ and corresponds to a 6-dimensional nilpotent Lie algebra. It contains both elliptic and hyperbolic cases. It is the Lie algebra generated by F_1, F_2 with the following Lie brackets relations :

$$\begin{aligned} F_3 &= [F_1, F_2] , & F_4 &= [F_3, F_1] \\ F_5 &= [F_3, F_2] , & F_6 &= [F_4, F_1] \\ & & [F_5, F_2] &= \lambda F_6 , \end{aligned}$$

and all other Lie brackets are 0.

Introducing $P_i = \langle p, F_i \rangle$ the geodesic equations are given by :

$$\begin{aligned} \dot{P}_1 &= P_3 P_2 , & \dot{P}_2 &= -P_3 P_1 , & \dot{P}_3 &= P_4 P_1 + P_5 P_2 , \\ \dot{P}_4 &= P_6 P_1 , & \dot{P}_5 &= \lambda P_6 P_2 \end{aligned}$$

and P_6 is a *Casimir first integral*. The value $\lambda = 0$ represents the bifurcation between the two cases.

5.2.2. Abnormal geodesics

Elliptic case The abnormal geodesics are contained in the Martinet surface :

$$\varepsilon y + x^2 + z^2 + 3mx^2 z^2 = 0$$

and are solutions of the equations :

$$\begin{aligned} \dot{x} &= (2z + 6mx^2 z) - \varepsilon \left(\frac{2x^3}{3} + 2mx^3 z^2 \right) \\ \dot{z} &= -(2x + 6mx^2 z). \end{aligned}$$

From [45], the singularity $x = z = 0$ is a weak focus and a spiral passing through 0 is with infinite length. Since any minimizer is smooth *no piece of abnormal geodesic is a minimizer* when computing the distance to 0.

Using the general result of [1], the sphere of small radius is the image by the exponential mapping of a compact set and it is subanalytic. This is also clearly shown by numerical simulations and the sphere is represented on Fig. 23.

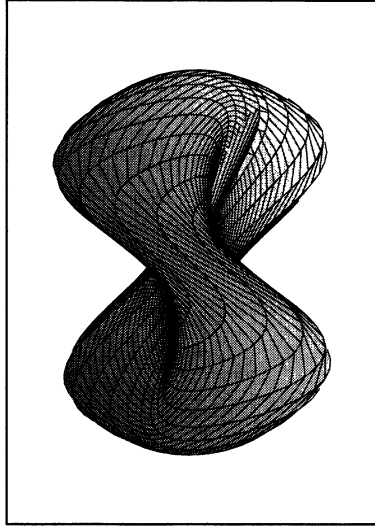

Figure 23. – Elliptic case

By taking $\varepsilon = 0$, the Martinet surface becomes : $x^2 + z^2 + 3mx^2z^2 = 0$ and reduces near 0 to : $x = z = 0$. Hence the spiral disappears. Since the weight of x, z is one and the weight of y is four, it corresponds to the nilpotent approximation of order -1 where m is 0.

Hyperbolic case The Martinet surface is given by the equation :

$$\varepsilon y + 2xz + 3mx^2z^2 = 0$$

and the abnormal geodesics are solutions of :

$$\begin{aligned} \dot{x} &= 2x - x^2z(\varepsilon - 6m) - 2mx^3z^2 \\ \dot{z} &= -(2z + 6mx^2z^2) \end{aligned}$$

and the singularity at $x = z = 0$ is a saddle point. *The two lines $x = 0$ and $z = 0$ are optimal for the metric $dx^2 + dz^2$.* Hence they play a role when computing the distance to 0. Numerical simulations show that *the sphere is not the image of a compact set*. This can be seen on Fig. 24 because the sphere cannot be numerically represented in the abnormal direction (there

is a hole). It is similar to the situation encountered in the Martinet case. The sphere is pinched in both abnormal directions.

The nilpotent approximation of order -1 is obtained by taking $\varepsilon = 0$ and $m = 0$. The Martinet surface becomes : $xz = 0$ and the two lines $x = 0$ and $z = 0$ remain abnormal geodesics.

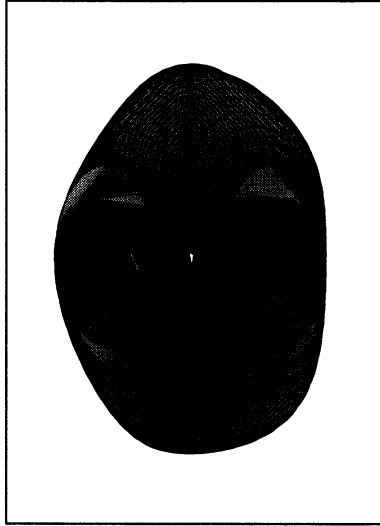

Figure 24. – Hyperbolic case

5.2.3. Normal geodesics

Elliptic case We take the frame :

$$F_1 = \frac{\partial}{\partial x} , \quad F_2 = \frac{\partial}{\partial z} + \left(\varepsilon xy + \frac{x^3}{3} + xz^2 + mx^3z^2 \right) \frac{\partial}{\partial y} , \quad F_3 = \frac{\partial}{\partial y}$$

and we introduce : $P_i = \langle p, F_i(q) \rangle$. The geodesics equations are :

$$\dot{x} = P_1$$

$$\dot{y} = P_2 \left(\varepsilon xy + \frac{x^3}{3} + xz^2 + mx^3z^2 \right)$$

$$\dot{z} = P_2$$

$$\dot{P}_1 = -(\varepsilon y + x^2 + z^2 + 3mx^2z^2)P_2P_3$$

$$\dot{P}_2 = (\varepsilon y + x^2 + z^2 + 3mx^2z^2)P_1P_3$$

$$\dot{P}_3 = -\varepsilon xP_3$$

and they can be truncated at order -1 by making $\varepsilon = m = 0$. In this case P_3 is a first integral and we can set : $P_3 = \lambda$. Moreover if we introduce : $P_1 = \sin \theta$, $P_2 = \cos \theta$, the equations become :

$$\dot{x} = \sin \theta , \quad \dot{z} = \cos \theta , \quad \dot{y} = \cos \theta \left(\frac{x^3}{3} + xz^2 \right)$$

$$\dot{\theta} = -(x^2 + z^2)P_3 , \quad P_3 = \lambda$$

They can be projected onto the space (x, y, θ) and the foliation is defined by :

$$\dot{x} = \sin \theta , \quad \dot{z} = \cos \theta , \quad \dot{\theta} = -(x^2 + z^2)\lambda$$

It is not Liouville-integrable but the equations can be integrated by quadratures, see [36]. Using polar coordinates : $x = r \cos \psi$, $z = r \sin \psi$, it becomes :

$$\dot{x} = \frac{\cos(\theta + \psi)}{r} , \quad \dot{r} = \sin(\theta + \psi) , \quad \dot{\theta} = -\lambda r^2$$

The important property is the following :

LEMMA 5.3. — *The sign of $\dot{\theta}$ is constant and reparametrizing the equation can be rewritten : $\dot{\theta} = 1$ as in the contact case.*

Numerical simulations

The geodesics equations can be integrated numerically. The projections in the plane (x, z) of the geodesics starting from 0 are flowers with three petals (they are circles in the Heisenberg case), see Fig. 25.

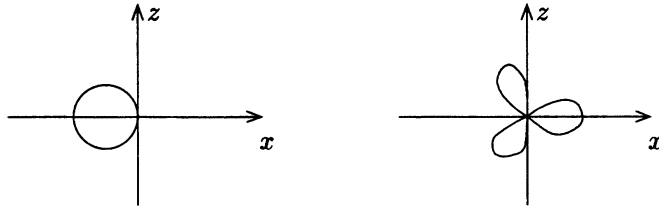

Figure 25

Hyperbolic case We take the frame :

$$F_1 = \frac{\partial}{\partial x} , \quad F_2 = \frac{\partial}{\partial z} + (\varepsilon xy + x^2 z + mx^3 z^2) \frac{\partial}{\partial y} , \quad F_3 = \frac{\partial}{\partial y}$$

and we introduce : $P_i = \langle p, F_i(q) \rangle$. The geodesics equations are :

$$\begin{aligned}\dot{x} &= P_1, \quad \dot{y} = P_2(\varepsilon xy + x^2 z + mx^3 z^2), \quad \dot{z} = P_2 \\ \dot{P}_1 &= -(\varepsilon y + 2xz + 3mx^2 z^2)P_2 P_3 \\ \dot{P}_2 &= (\varepsilon y + 2xz + 3mx^2 z^2)P_1 P_3 \\ \dot{P}_3 &= -\varepsilon x P_2 P_3\end{aligned}$$

and they can be truncated at order -1 by making $\varepsilon = m = 0$. In this case P_3 is a first integral and we can set : $P_3 = \lambda$. Moreover if we introduce : $P_1 = \sin \theta$, $P_2 = \cos \theta$, the equations become :

$$\begin{aligned}\dot{x} &= \sin \theta, \quad \dot{z} = \cos \theta, \quad \dot{y} = \cos \theta x^2 z \\ \dot{\theta} &= -2xz P_3, \quad P_3 = \lambda\end{aligned}$$

They can be projected onto the space (x, z, θ) .

Numerical simulations

The projected equations : $\dot{x} = \sin \theta, \dot{z} = \cos \theta, \dot{\theta} = -2xz \lambda$ can be integrated numerically and the solutions compared with the pendulum : $\dot{x} = \sin \theta, \dot{z} = \cos \theta, \dot{\theta} = -\lambda x$, see Fig. 26. The behaviour is *quite chaotic* and θ exhibits oscillating and dissipative phenomena. Also it shows in the plane (x, z) a *coupling effect between the two abnormal directions*.

The SR sphere in the tangential hyperbolic sphere is represented on Fig. 27.

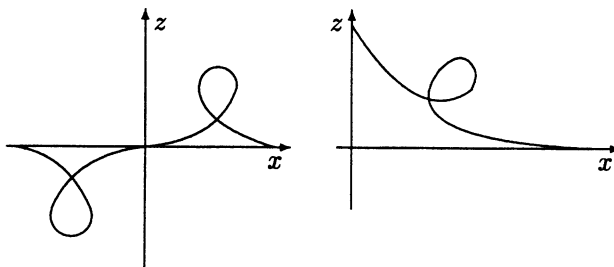

Figure 26

5.2.4. Conclusion

The elliptic situation is similar to the contact case. The analysis of the hyperbolic case is intricate. A tool to study the sphere is to introduce as

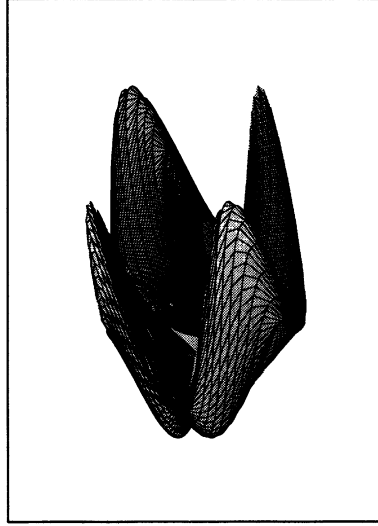

Figure 27. – Tangential hyperbolic sphere

in the Martinet case a return mapping by taking the intersections of the geodesics with one of the planes : $x = 0$ or $z = 0$. The non properness of this application can be checked numerically.

5.3. The Engel case and left-invariant SR geometry on nilpotent Lie groups

If $q = (x, y, z, w)$, we consider the system in \mathbb{R}^4 :

$$F_1 = \frac{\partial}{\partial x} + y \frac{\partial}{\partial z} + \frac{y^2}{2} \frac{\partial}{\partial w}, \quad F_2 = \frac{\partial}{\partial y}$$

We have the following relations : $F_3 = [F_1, F_2] = \frac{\partial}{\partial z} + y \frac{\partial}{\partial w}$, $F_4 = [[F_1, F_2], F_2] = \frac{\partial}{\partial w}$ and $[[F_1, F_2], F_1] = 0$. Moreover all Lie brackets with length greater than 4 are equal to zero. Set :

$$L_1 = \begin{pmatrix} 0 & 0 & 0 & 0 \\ 0 & 0 & 1 & 0 \\ 0 & 0 & 0 & 1 \\ 0 & 0 & 0 & 0 \end{pmatrix}, \quad L_2 = \begin{pmatrix} 0 & 1 & 0 & 0 \\ 0 & 0 & 0 & 0 \\ 0 & 0 & 0 & 0 \\ 0 & 0 & 0 & 0 \end{pmatrix}$$

and define the following representation : $\rho(F_1) = L_1, \rho(F_2) = L_2$ which allows to identify the previous system in \mathbb{R}^4 to the *left-invariant system* $\dot{R} =$

$(u_1L_1 + u_2L_2)R$ on the Engel group G_e , here represented by the nilpotent matrices :

$$\begin{pmatrix} 1 & q_2 & q_3 & q_4 \\ 0 & 1 & q_1 & \frac{q_2^2}{2} \\ 0 & 0 & 1 & q_1 \\ 0 & 0 & 0 & 1 \end{pmatrix}$$

The weight of x, y is one, the weight of z is two, and the weight of w is three. For any sub-Riemannian metric on G_e , the approximation of order -1 is the flat metric $g = dx^2 + dy^2$. Any sub-Riemannian Martinet metric can be written $g = adx^2 + cdy^2$ and can be lifted on G_e .

5.3.1. Parametrization of geodesics in the flat case

Non trivial abnormal extremals are solutions of :

$$P_1 = P_2 = \{P_1, P_2\} = 0, \quad u_1\{\{P_1, P_2\}, P_1\} + u_2\{\{P_1, P_2\}, P_2\} = 0$$

Set $p = (p_x, p_y, p_z, p_w)$. We get :

$$p_x + p_z y + p_w \frac{y^2}{2} = p_y = p_z + y p_w = p_w u_2 = 0$$

This implies $p_w \neq 0$ and thus $u_2 = 0$. The abnormal flow is given by :

$$\dot{x} = u_1, \quad \dot{y} = 0, \quad \dot{z} = u_1 y, \quad \dot{w} = u_1 \frac{y^2}{2}$$

where $|u_1| = 1$ if the parameter is the length.

To compute normal extremals, we set $P_i = \langle p, F_i(q) \rangle, i = 1, 2, 3, 4$ and $H_n = \frac{1}{2}(P_1^2 + P_2^2)$; we get :

$$\dot{P}_1 = P_2 P_3, \quad \dot{P}_2 = -P_1 P_3, \quad \dot{P}_3 = P_2 P_4, \quad \dot{P}_4 = 0$$

Parametrizing by the length $H_n = \frac{1}{2}$, we may set : $P_1 = \cos \theta, P_2 = \sin \theta$, and if $\theta \neq k\pi$ we get : $\dot{\theta} = -P_3, \quad \ddot{\theta} = -P_2 P_4$. Denote $P_4 = \lambda$, then this is equivalent to the pendulum equation :

$$\ddot{\theta} + \lambda \sin \theta = 0$$

Let L denote the abnormal line starting from $0 : t \mapsto (\pm t, 0, 0, 0)$. It is not strict and projects onto $\theta = k\pi$.

In order to obtain an uniform representation of normal geodesics, we shall use the *Weierstrass elliptic function* \mathcal{P} . Indeed the system admits three

integrals : $P_1^2 + P_2^2 = 1$, and two Casimir functions : $-2P_1P_4 + P_3^2 = C$ et $P_4 = \lambda$. Using $\dot{P}_1 = P_2P_3$ we get : $\dot{P}_1 = -CP_1 - 3\lambda P_1^2 + \lambda$, which is equivalent, with $\dot{P}_1 \neq 0$ and $\lambda \neq 0$, to the equation : $\dot{P}_1^2 = -2\lambda(P_1^3 + \frac{C}{2\lambda}P_1^2 - P_1 + D)$. Let $\mathcal{P}(u)$ denote the Weierstrass elliptic function (cf [26]) solution of :

$$\mathcal{P}'(u) = -2\sqrt{(\mathcal{P}(u) - e_1)(\mathcal{P}(u) - e_2)(\mathcal{P}(u) - e_3)}$$

where the complex numbers e_i satisfy $e_1 + e_2 + e_3 = 0$. Set $g_2 = -4(e_2e_3 + e_3e_1 + e_1e_2)$ and $g_3 = 4e_1e_2e_3$; then : $\mathcal{P}'(u) = 4\mathcal{P}^3(u) - g_2\mathcal{P}(u) - g_3$. The function $\mathcal{P}(u)$ can be expanded at 0 in the following way :

$$\mathcal{P}(u) = \frac{1}{u^2} + \frac{1}{20}g_2u^2 + \frac{1}{28}g_3u^4 + \dots$$

Hence the solution P_1 can be written : $a\mathcal{P}(u) + b$. Then we can compute P_2 and P_3 using the integrals, and x, y, z, w can be computed by quadratures. We find again oscillating and rotating solutions of the pendulum using Jacobi elliptic functions given by the formulas :

$$\text{cn } u = \left(\frac{\mathcal{P}(u) - e_1}{\mathcal{P}(u) - e_2} \right)^{\frac{1}{2}}, \quad \text{dn } u = \left(\frac{\mathcal{P}(u) - e_2}{\mathcal{P}(u) - e_3} \right)^{\frac{1}{2}}$$

5.3.2. Heisenberg and Martinet flat cases deduced from the Engel case. Blowing-up in lines

Note that the two vector fields $\frac{\partial}{\partial z}$ and $\frac{\partial}{\partial w}$ commute with F_1 and F_2 . The Engel case contains the flat contact case and the flat Martinet case which are given by the following operations :

- Setting $p_z = 0$, we obtain the geodesics of the Heisenberg case.
- Setting $p_w = 0$, we obtain the geodesics of the Martinet flat case.

The interpretation is the following.

LEMMA 5.4. — *We obtain the Martinet flat case (resp. Heisenberg) by minimizing the SR distance to the line (Oz) (resp. (Ow)).*

Indeed the condition $p_z = 0$ (resp. $p_w = 0$) corresponds to the *transversality condition*. It may be observed that, since the SR distance to a line is more regular than to a point, the SR distance in the Engel case has at least all singularities of the Heisenberg and Martinet flat cases.

Another way to get the Martinet flat case is to use the following general fact from [7] :

LEMMA 5.5. — *The Martinet flat case is isometric to $(G_{e/H}, dx^2 + dy^2)$ where H is the following sub-group of $G_e : \{\exp t[F_1, F_2] \mid t \in \mathbb{R}\}$.*

The Engel case can be imbedded in any dimension, for more details about left-invariant SR-geometry on nilpotent Lie groups see [39].

In the Martinet flat case, using the uniform parametrization of the geodesics by elliptic functions, the sphere is evaluated in any direction.

Next we give a description of the SR sphere in an abnormal direction when the flag associated to the distribution D satisfies $D^3 \neq D^2$, see Section 3.4.

5.4. Microlocal analysis of the singularity of the SR sphere in the abnormal direction

The aim of this Section is to stratify the singularity of the SR sphere in the abnormal direction. We use symplectic geometry. This leads to a stratification of the solutions of the Hamilton-Jacobi-Bellman equation viewed in the cotangent bundle.

5.4.1. Lagrangian manifolds and generating mapping

DEFINITION 5.1. — Let (M, ω) be a smooth symplectic manifold and $L \subset M$ be a smooth regular submanifold. We say that L is isotropic if the restriction of ω to TL is equal to zero, and if $\dim L = \frac{1}{2} \dim M$ then L is called Lagrangian.

The following result is crucial, see [32].

PROPOSITION 5.6. — *Let (M, ω) be a $2n$ -dimensional manifold and $L \subset M$ be a Lagrangian submanifold. Then there exists Darboux local coordinates (q, p) and a smooth function $S(q_I, p_{\bar{I}})$ where $I = \{1, \dots, m\}$, $\bar{I} = \{m + 1, \dots, n\}$ is a partition of $\{1, \dots, n\}$ such that L is given locally by the equations :*

$$p_I = \frac{\partial S}{\partial q_I}, \quad q_{\bar{I}} = -\frac{\partial S}{\partial p_{\bar{I}}}$$

DEFINITION 5.2. — The mapping S which represents locally L is called the *generating mapping* of L .

DEFINITION 5.3. — Let L be a Lagrangian manifold and Π the standard projection $(q, p) \mapsto q$ from TM onto M . The caustic is the projection on M of the singularities of (L, Π) .

5.4.2. Lagrangian manifolds and SR normal case

Consider the SR problem :

$$\dot{q} = u_1 F_1(q) + u_2 F_2(q), \quad q \in M$$

where the length of q is :

$$L(q) = \int_0^T (u_1^2(t) + u_2^2(t))^{\frac{1}{2}} dt$$

We use the notations of Section 3.2. Let $P_i = \langle p, F_i(q) \rangle, i = 1, 2$, the Hamiltonian associated to normal geodesics is given by $H_n = \frac{1}{2}(P_1^2 + P_2^2)$.

Let $t \mapsto \gamma(t), t \in [0, T]$ be a reference one-to-one normal geodesic. We assume the following :

Hypothesis : We assume that the reference geodesic is *strict*, i.e. there exists a unique lifting $[\tilde{\gamma}]$ of γ in the projective bundle $P(T^*M)$.

Notations

- $\exp_{\gamma(0)}$ is the exponential mapping. If the geodesics are parametrized by arc-length $H_n = \frac{1}{2}$, it is defined by $t \mapsto \Pi(\tilde{q}(t))$ where $t \mapsto \tilde{q}(t)$ is a solution of \vec{H}_n starting from $\gamma(0)$ at time $t = 0$.
- $L_t = \exp t\vec{H}_n(T_{\gamma(0)}^*M)$, where $\exp t\vec{H}_n$ is the local one-parameter group associated to \vec{H}_n .

The length of a curve does not depend on the parametrization and the optimal control problem is *parametric*. This induces a symmetry which has to be taken into account when writing Hamilton-Jacobi equation in the normal case. Indeed we have :

LEMMA 5.7. — *The solutions of \vec{H}_n satisfy the relation :*

$$q(t, q_1, \lambda p_1) = q(\lambda t, q_1, p_1), \quad p(t, q_1, \lambda p_1) = \lambda p(\lambda t, q_1, p_1)$$

The following results are standard :

- PROPOSITION 5.8. 1. $L_0 = T_{\gamma(0)}^*M$ is a linear Lagrangian manifold, and for each $t > 0$, L_t is a Lagrangian manifold.
2. The time t_c is conjugate along γ if and only if the projection $\Pi : L_{t_c} \rightarrow M$ is singular at $\tilde{\gamma}(t_c)$.

3. Assume that geodesics are parametrized by arc-length t , and let

$$W = \bigcup_{0 < t \leq T} \exp t\vec{H}_n(T_{\gamma(0)}^*M \cap (H_n = \frac{1}{2}))$$

where $T < t_{1c}$ (first conjugate time along γ). Then $\mathcal{E} = \Pi(W)$ is a central field along γ .

Remark 5.2. • The caustic of L_t is the set of conjugate points which can be analyzed using Lagrangian singularities.

- We represent locally W by an Hamilton-Jacobi or wave function defined as follows. We integrate the normal flow starting from $\gamma(0)$ and parametrized by arc-length : $P_1^2 + P_2^2 = 1$. By setting $P_1(0) = \cos \theta$, this gives us the family of geodesics :

$$E : p = (\theta, \lambda_1, \dots, \lambda_{n-2}, t) \in \mathbf{S}^1 \times \mathbb{R}^{n-1} \mapsto M$$

and p is eliminated by solving the equation $E(p) = q$ near $\gamma(t)$ using the Implicit Function Theorem. Beyond the computations need the Preparation Theorem and *Legendrian singularity theory*.

Next we describe the tangent space to the Lagrangian manifold.

DEFINITION 5.4. — We denote by (V_n) the variational equation :

$$\delta \dot{q} = \frac{\partial \vec{H}_n}{\partial \tilde{\gamma}}(\tilde{q}(t))\delta q \tag{47}$$

along the reference trajectory $t \mapsto \tilde{\gamma}(t)$. This Hamiltonian linear equation is called *Jacobi equation*. A *Jacobi field* $J(t) = (\delta q(t), \delta p(t))$ is a nontrivial solution of (47). It is called *vertical* if $\delta q(0) = 0$.

PROPOSITION 5.9. 1. Let $L_t = \exp t\vec{H}_n(T_{\gamma(0)}^*M)$. Then the space of vertical Jacobi fields is the tangent space to L_t for $t > 0$.

2. Assume we are in the analytic category. Let $J(\cdot)$ be a vertical Jacobi field and let $\varepsilon \mapsto \alpha(\varepsilon)$ be an analytic curve such that $\alpha(0) = J(0)$. If Y is an analytic vector field on T^*M such that $Y(\tilde{\gamma}(0)) = \alpha(0)$, then $t \mapsto J(t)$ is given for t small by the Baker-Campbell-Hausdorff formula :

$$J(t) = \sum_{n \geq 0} \frac{t^n}{n!} \text{ad}^n \vec{H}_n(Y)(\tilde{\gamma}(t))$$

A consequence of Lemma 5.7 is :

LEMMA 5.10. — Let $\tilde{\gamma}(0) = (q_0, p_0)$ and consider the curve $\alpha(\varepsilon) = (q_0, p_0 + \varepsilon p_0)$. Then it is a vertical curve, and if J_1 is the associated Jacobi field then $\Pi(J_1(t)) = t\dot{\gamma}(t)$.

5.4.3. Isotropic manifolds and SR abnormal case

Consider the system $\dot{q} = u_1 F_1(q) + u_2 F_2(q)$. According to Section 3, the abnormal geodesics are solutions of the equations :

$$\frac{dq}{dt} = \frac{\partial H_a}{\partial p}, \quad \frac{dp}{dt} = -\frac{\partial H_a}{\partial q}$$

where $H_a = u_1 P_1 + u_2 P_2$. They are contained in :

$$P_1 = P_2 = \{P_1, P_2\} = 0$$

and the abnormal controls are computed using :

$$u_1 \{\{P_1, P_2\}, P_1\} + u_2 \{\{P_1, P_2\}, P_2\} = 0$$

Assumptions. Let $t \mapsto \gamma(t)$, $t \in [-T, T]$ be a one-to-one abnormal reference geodesic. One may assume that it corresponds to the control $u_2 = 0$. We suppose that the following conditions are satisfied along γ for the couple (F_1, F_2) , see Section 2.5.

- (H₁) The first order Pontryagin's cone $K(t) = \text{Span} \{ad^k F_1.F_2|_\gamma / k \in \mathbb{N}\}$ has codimension one and is generated by $\{F_2, \dots, ad^{n-2} F_1.F_2\}|_{\gamma(t)}$.
- (H₂) If $n \geq 3$, for each t , $F_1(\gamma(t)) \notin \text{Span} \{ad^k F_1.F_2|_\gamma / k = 0 \dots n - 3\}$.
- (H₃) $\{P_2, \{P_1, P_2\}\} \neq 0$ along γ .

Notations

- Under the previous assumptions γ admits an unique lifting $[\tilde{\gamma}] = (\gamma, p_\gamma)$ in $P(T^*M)$. One may identify locally M to a neighborhood U of $\gamma(0) = 0$ in \mathbb{R}^n . Let V be a neighborhood of p_γ in $P(T_0^*U)$. We can choose V small enough such that all abnormal geodesics starting from $\{0\} \times V$ satisfy the assumptions (H₁ – H₃). We denote by Σ_r the sector of U covered by abnormal geodesics with length $\leq r$ and starting from $\{0\} \times V$. This defines a mapping denoted Exp. The construction is represented on Fig. 28.
- On $\Omega = T^*M \setminus (\{\{P_1, P_2\}, P_2\} = 0)$ let \hat{H}_a be the Hamiltonian $\hat{H}_a = P_1 + \hat{u}P_2$ where $\hat{u} = -\frac{\{\{P_1, P_2\}, P_1\}}{\{\{P_1, P_2\}, P_2\}}$, and let $\exp t\vec{\hat{H}}_a$ be the one-parameter local group. We denote by L_t^a (resp. I_t^a) the image of $T_{\gamma(0)}^*M$ (resp. $T_{\gamma(0)}^*M \cap (P_1 = P_2 = \{P_1, P_2\} = 0)$).

LEMMA 5.11. — *On Ω , L_t^a is a Lagrangian submanifold and I_t^a is an isotropic submanifold.*

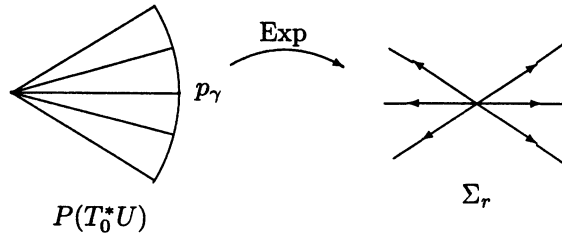

Figure 28

5.4.4. The smooth abnormal sector of the SR sphere

LEMMA 5.12. — Consider the SR problem where γ is an abnormal reference trajectory and assume $(H_1 - H_3)$. It can be identified to a trajectory of F_1 where the system (F_1, F_2) is orthonormal. Then the abnormal geodesic is strict, and there exists $r > 0$ such that if the length of γ is less than r then γ is a global minimizer.

Proof. — Under assumption (H_1) the first order Pontryagin’s cone along γ has codimension one, and from (H_3) γ is not a normal geodesic. The optimality assertion follows from [6], see also [29]. \square

Hence the end-point of γ belongs to the sphere. Moreover r can be estimated and the estimate is uniform for each abnormal geodesic C^1 -close to γ . Therefore we have :

PROPOSITION 5.13. — For r small enough Σ_r is a sector of the SR ball homeomorphic to $C \cup -C$, where C is a positive cone of dimension $n - 3$ if $n \geq 4$ and 1 if $n = 3$. Its intersection with the sphere consists of two (C^∞ or C^ω) surfaces of dimension $n - 4$ if $n \geq 4$ and reduced to two points if $n = 3$.

5.4.5. Gluing both normal and abnormal parts

The tangent space to the sphere near the abnormal directions is described by the results of Section 5.1, namely Theorem 5.2.

Let A be the end-point of the abnormal trajectory and let $K(r)$ be the first order Pontryagin’s cone evaluated at A , r small enough. Let $\varepsilon \mapsto \alpha(\varepsilon)$ be a C^1 curve on the sphere $S(0, r)$, $\alpha(0) = A$, $\varepsilon \geq 0$. Assume the following :

1. $\alpha(\varepsilon) \subset S(0, r) \setminus \Sigma_r$ for $\varepsilon \neq 0$.

2. $\alpha(\varepsilon) \cap L = \emptyset$, where L is the cut-locus for geodesics starting from 0.

Then the tangent space to the sphere evaluated at $\alpha(\varepsilon)$ tends to $K(r)$ when $\varepsilon \rightarrow 0$ (see Fig. 29).

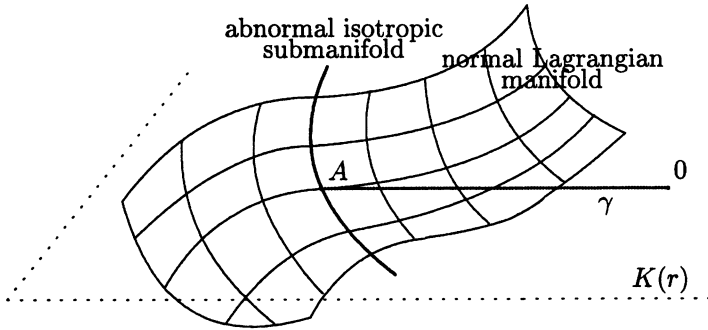

Figure 29

5.4.6. Lagrangian splitting and the Martinet sector

DEFINITION 5.5. — We call *Martinet sector* of the Martinet sphere the trace of the ball $B(0, r)$ with the Martinet plane identified to $y = 0$.

A precise description is obtained if we use the pendulum representation of Section 4, where the metric is truncated to order 0 : $g = (1 + \alpha y)^2 dx^2 + (1 + \beta x + \gamma y)^2 dy^2$. The abnormal geodesic is strict if and only if $\alpha \neq 0$. The pendulum equation is :

$$\theta'' + \sin \theta + \varepsilon \beta \cos \theta \theta' + \varepsilon^2 \alpha \sin \theta (\alpha \cos \theta - \beta \sin \theta) = 0$$

where $\varepsilon = \frac{1}{\sqrt{\lambda}}$ is a *parameter*. Cutting by $y = 0$ induces a *one-parameter* section :

$$S : \theta' = \varepsilon (\alpha \cos \theta + \beta \sin \theta)$$

The trace of the sphere with the Martinet plane near the end-point $A = (-r, 0, 0)$ of the abnormal direction is described in Section 4. We take the first and second intersections of the pendulum trajectories with S , see Fig. 30.

In the conservative case, the curves D_1, D_2 correspond to *oscillating* trajectories of the pendulum, and the curve C_1 corresponds to *rotating* trajectories.

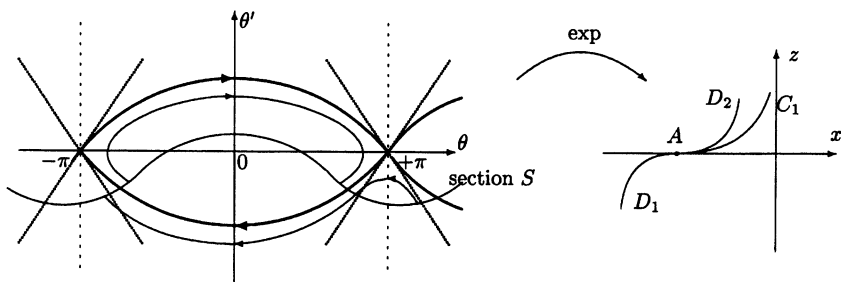

Figure 30. - ($a \neq 0$)

Only one of the curves C_1, D_2 belongs to the sphere (this is D_2 on the figure) and their respective positions depend on the Gauss curvature of the restriction of the metric g to the plane (x, y) .

Contacts are the following.

PROPOSITION 5.14. — Let $Z = \frac{z}{r^3}$ and $X = \frac{x+r}{2r}$. Then :

$$C_1, D_2 : Z = \left(\frac{1}{6} + O(r)\right)X^3 + o(X^3).$$

$$D_1 : Z = -\frac{2}{r^2\alpha^2}X^2 + o(X^2).$$

This allows to describe the Martinet sector in the ball.

PROPOSITION 5.15. — In the strict case $\alpha \neq 0$ the Martinet sector has the following properties.

1. It is the image by the exponential mapping of a non compact subset of the cylinder : $(\theta(0), \lambda), \lambda \rightarrow \infty$.
2. It is homeomorphic to a conic sector centered on the abnormal line.
3. It is foliated by leaves D_1, E_1 in the spheres $S(0, \varepsilon), \varepsilon \leq r$, which glue according to Fig. 31.

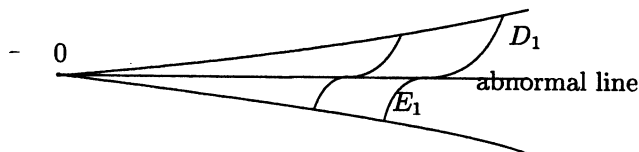

Figure 31

The Lagrangian splitting. In the pendulum representation, the transport of $T_{\gamma(0)}^*M \cap \{H_n = \frac{1}{2}\}$ by the normal flow has the following basic interpretation, see Fig. 32.

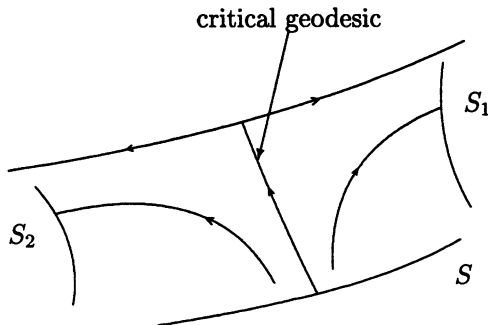

Figure 32

The section splits into two parts S_1, S_2 which represent the splitting of the fiber $T_{\gamma(0)}^*M$ into two Lagrangian manifolds.

5.4.7. Microlocal invariants

The pendulum has two singular points $F = (0, 0)$ and $S = (0, \pi)$. The local analysis is as follows.

- Near F , the linearized system is a *focus* whose eigenvalues are :

$$\sigma_{\pm} = -\frac{\varepsilon\beta}{2} \pm i\sqrt{1 + \varepsilon^2\left(\frac{\beta^2}{4} - \alpha^2\right)}$$

and is a perturbation of the linearized pendulum $\theta'' + \theta = 0$ of the flat case.

- Near S , the linearized system is a *saddle* whose eigenvalues are :

$$\eta_{\pm} = \frac{\varepsilon\beta}{2} \pm \sqrt{1 + \varepsilon^2\left(\frac{\beta^2}{4} - \alpha^2\right)} = \pm 1 + \frac{\varepsilon\beta}{2} + o(\varepsilon)$$

where $\varepsilon = \frac{1}{\sqrt{\lambda}}$. It is a perturbation of the flat case $\eta_{\pm} = \pm 1$ which is *resonant*.

In order to compute the sector we use the *spectrum band* η_{\pm} which is stable by perturbation. When we compute the sphere we have to compute an *averaging*. This is much more complex.

The linear pendulum appears already in the contact case and the existence of the focus reflects the existence of a contact sector in the Martinet sphere.

5.4.8. The sectors of the Martinet sphere

In [10] was described the Martinet sphere in the integrable case by gluing sectors. We have three kinds of sectors :

- A Riemannian sector R located near the equator, image of $\lambda = 0$.
- A contact sector around C , where C is a cut-point.
- A Martinet sector around A , where A is an end-point of the abnormal line.

The sectors are represented on Fig. 33.

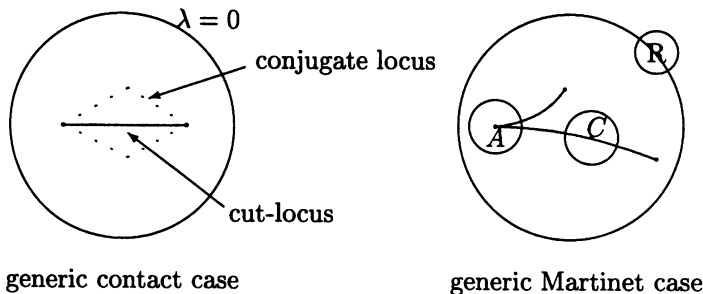

Figure 33

The microlocal invariants of the SR balls are the following :

- Spectrum band corresponding to the focus F .
- Spectrum band corresponding to the saddle S .
- Invariants connected to the family of Riemannian structures $a(q)dx^2 + b(q)dy^2$ induced on the plane (x, y) , where z is taken as a parameter.

The conjugate points accumulate in the flat case along the abnormal direction, see [2].

5.4.9. The n -dimensional case

Our results except the precise asymptotics of Section 4 can be generalized to the n -dimensional case to define a Martinet sector in the SR ball. Indeed :

- L^2 -compactness of SR minimizers (see [1]) allows to bound the number of oscillations of Lagrangian manifolds. It appears in our study by taking only the first and second return mapping to compute the sphere intersected with $y = 0$.
- From [41], using a normal form, we can cut the SR ball by a 2-dimensional plane to identify a Martinet sector which splits into two curves : a curve D_1 obtained by using minimizing controls close to the reference abnormal control in L^∞ -topology ; a curve E_1 obtained by using controls close to the reference abnormal control in L^2 -topology, but not in L^∞ -topology (see Fig. 34).

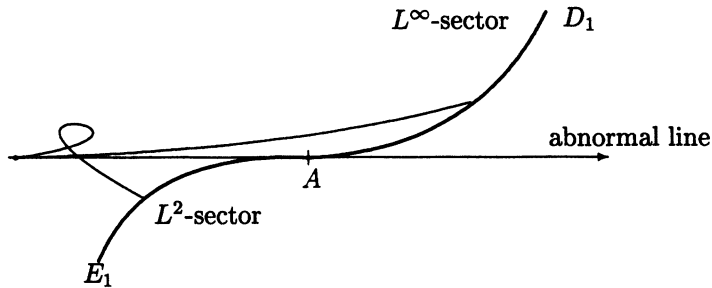

Figure 34

The picture explains well the consequence of the existence of abnormal minimizers in SR geometry. Contrarily to the classical case we cannot straight the geodesic flow near the abnormal direction to form a central field.

6. Conclusion

Our analysis explains the role of abnormal geodesics in SR geometry. It is based on the Martinet case. Using our gradated normal form of order 0, the geodesics foliation is projected onto a one-dimensional foliation in a plane which corresponds to a *one-parameter family of pendulums*. In this space the abnormal line projects on the singularities of the foliation. The computation of the sphere in the abnormal direction is related to the computation of return mappings evaluated along the separatrices of the pendulum. We have computed *asymptotics*, using techniques similar to the ones used in the Hilbert's 16th problem. The computations are complex, because it is a singular perturbation analysis. In these computations one needs to consider geodesics C^1 -close to the abnormal reference trajectory on the one part, and geodesics which are C^0 -close, but not C^1 -close to the abnormal reference trajectory on the other part. Our asymptotics are not complete in the latter case and this requires further studies. Moreover the techniques have to be

adapted to analyze the general case when the geodesics equations are not projectable. This leads to *stability questions about our asymptotics*.

The projection of the geodesics flow onto a planar foliation, valid at order 0 in the Martinet case, is useful to compute asymptotics but is not crucial from the geometric point of view, and Martinet geometry is representative of SR geometry with abnormal minimizers. The existence of such minimizers implies *hyperbolicity* seen in the pendulum representation as the behaviors of the geodesics near the separatrices. The general geometric framework to analyze SR geometry is Lagrangian manifolds. Here hyperbolicity due to the existence of abnormal directions is interpreted as a *splitting* of the Lagrangian fiber $T_{q_0}^*M$ when transported by the normal flow. To construct the sphere in the abnormal direction we must glue together the projections of several manifolds in the cotangent space.

The link between the computations of asymptotics and Lagrangian geometry is the Jacobi fields which allow to compute contacts for the return mapping underlying our analysis. In general the evaluation of a return mapping in the analysis of a differential equation interpreted as a transport problem is original and source of further studies.

The question of the category of the SR Martinet sphere is still open. The Martinet sector is homeomorphic to a locally convex cone and we have given a qualitative description of its singularities. In the integrable case the SR sphere is log-exp and this leads to a smooth stratification of the sphere. In general we conjecture that the sphere is not log-exp, belongs to some extended Il'Yashenko's category, and is still C^1 -stratifiable. It is an important question connected to *Hamilton-Jacobi equation* which has many applications in physics (optics, quantum theory). For control theory, SR geometry is part of optimal control. Moreover our study is related to the stabilization problem.

Bibliography

- [1] AGRACHEV (A.). — Compactness for sub-Riemannian length minimizers and subanalyticity, Rend. Semin. Mat. Torino, Vol. 56, 1999.
- [2] AGRACHEV (A.), BONNARD (B.), CHYBA (M.), KUPKA (I.). — Sub-Riemannian sphere in the Martinet flat case, ESAIM/COCV, Vol. 2, 377-448, 1997.
- [3] AGRACHEV (A.), EL ALAOUI, GAUTHIER (J.P.). — Sub-Riemannian metrics on \mathbb{R}^3 , Canadian Math. Cont. Proc., Vol. 25, 29-76, 1998.
- [4] AGRACHEV (A.), EL ALAOUI, GAUTHIER (J.P.), KUPKA (I.). — Generic singularities of sub-Riemannian on \mathbb{R}^3 , C.R.A.S., Paris, 377-384, 1996.

- [5] AGRACHEV (A.), SARYCHEV (A.). — On abnormal extremals for Lagrange variational problems, *J. Math. Systems, Estimation and Control*, Vol. 8, No. 1, 1998, 87-118.
- [6] AGRACHEV (A.), SARYCHEV (A.). — Strong minimality of abnormal geodesics for 2-distributions in SR-geometry, *J. of Dynamical and Control Systems*, Vol. 1, No. 2, 139-176, 1995.
- [7] BELLAÏCHE (A.), RISLER (J.J.) (Editors). — *Sub-Riemannian geometry*, Birkhäuser, 1996, *Progress in Mathematics*, Vol. 144.
- [8] BLISS (G.A.). — , *Lectures on the calculus of variations*, University of Chicago Press, Chicago, 1946.
- [9] BONNARD (B.). — Feedback equivalence for nonlinear systems and the time optimal control problem, *SIAM J. on control and optimization*, 29, 1300-1321, 1991.
- [10] BONNARD (B.), CHYBA (M.). — Méthodes géométriques et analytiques pour étudier l'application exponentielle, la sphère et le front d'onde en géométrie SR dans le cas Martinet, *ESAIM/COCV*, Vol. 4, 245-334, 1999.
- [11] BONNARD (B.), HEUTTE (H.). — La propriété de stricte anormalité est générique, *Preprint Labo. de Topologie Dijon*, 1995.
- [12] BONNARD (B.), KUPKA (I.). — Théorie des singularités et optimalité des trajectoires singulières dans le problème du temps minimal, *Forum Math.* 5, 111-159, 1991.
- [13] BONNARD (B.), KUPKA (I.). — Generic properties of singular trajectories, *Annales de l'IHP, Analyse non linéaire*, Vol. 14, No. 2, 167-186, 1997.
- [14] BONNARD (B.), LAUNAY (G.), TRÉLAT (E.). — The transcendence we need to compute the sphere and wave front in Martinet SR-geometry, *Contemporary Mathematics and its Applications*, Vol. 64, VINITI, Moscow, 1999, pp 82-117. English version in *Journal of Mathematical Sciences (Kluwer)*, Vol. 103 (6), 2001, pp 688-708.
- [15] BRUNO (A.D.). — *Local methods in nonlinear differential equations*, Springer Verlag, 1989.
- [16] CHAPERON (M.). — *Géométrie différentielle et singularités des systèmes dynamiques*, Astérisque 138-139, SMF, 1986.
- [17] CHYBA (M.). — *Le cas Martinet en géométrie sous-Riemannienne*, Thèse de l'Université de Bourgogne, 1997.
- [18] DAVIS (H.). — *Introduction to nonlinear differential and integral equations*, Dover, 1962.
- [19] VAN DEN DRIES (L.), MACINTYRE (A.), MARKER (D.). — The elementary theory of restricted analytic fields with exponentiation, *Annals of Mathematics*, 140, 183-205, 1994.
- [20] VAN DEN DRIES (L.), MILLER (C.). — Geometric categories and o-minimal structures, *Duke Math. Journal*, Vol. 84, No. 2, 1996.
- [21] HEUTTE (H.). — Propriétés génériques des extrémales singulières dans le cas multi-entrée, *Preprint Labo. de Topologie Dijon*, 1995.
- [22] IL'YASHENKO (Yu.S.). — *Finiteness theorems for limit cycles*, *Translations of Mathematical Monographs*, Vol. 94, 1991.
- [23] KRENER (A.J.). — The higher order maximal principle and its applications to singular extremals, *SIAM J. on Control and Opt.*, Vol. 15, 256-293, 1977.
- [24] KUPKA (I.). — *Abnormal extremals*, *Preprint*, 1992.
- [25] KUPKA (I.). — *Géométrie sous-Riemannienne*, Séminaire Bourbaki, 1996.
- [26] LAWDEN (D.F.). — , *Elliptic functions and applications*, Springer Verlag, 1980.
- [27] LEE (E.B.), MARKUS (L.). — *Foundations of optimal control theory*, John Wiley, New York, 1967.

- [28] LION (J.M.), ROLIN (J.P.). — Théorèmes de préparation pour les fonctions logarithmico-exponentielles, Annales de l'Institut Fourier, Tome 47, Fasc. 3, 859-884, 1997.
- [29] LIU (W.S.), SUSSMANN (H.J.). — Shortest paths for sub-Riemannian metrics of rank two distributions, Memoirs AMS, No. 564, Vol. 118, 1995.
- [30] LOJASIEWICZ (S.), SUSSMANN (H.J.). — Some examples of reachable sets and optimal cost functions that fail to be subanalytic, SIAM J. on Control and Opt., Vol. 23, No. 4, 584-598, 1985.
- [31] LOVE (A.E.H.). — A treatise of the mathematica theory of elasticity, Dover, 1944.
- [32] MISCHENKO (A.S.) and al. — Lagrangian manifolds and the Maslov operator, Springer Verlag, New York, 1980.
- [33] MONTGOMERY (R.). — Abnormal minimizers, SIAM J. on Control and Opt., Vol. 32, No. 6, 1605-1620, 1997.
- [34] MOURTADA (A.), MOUSSU (R.). — Applications de Dulac et applications pfaffiennes, Bulletin SMF, 125, 1-13, 1997.
- [35] MOUSSU (R.), ROCHE (A.). — Théorie de Khovanski et problème de Dulac, Inv. Math., 105, 431-441, 1991.
- [36] PELLETIER (M.). — Communication personnelle.
- [37] PONTRIAGUINE (L.) et al. — Théorie mathématique des processus optimaux, Eds Mir, Moscou, 1974.
- [38] ROUSSARIE (R.). — Bifurcations of planar vector fields and Hilbert's 16th problem, Birkhäuser, Berlin, 1998.
- [39] SACHKOV (Y.L.). — Symmetries of flat rank two distributions and sub-Riemannian structures, Preprint Labo. de Topologie Dijon, 1998.
- [40] TRÉLAT (E.). — Some properties of the value function and its level sets for affine control systems with quadratic cost, Journal of Dynamical and Control Systems, Vol. 6, No. 4, Oct. 2000, 511-541.
- [41] TRÉLAT (E.). — Etude asymptotique et transcendance de la fonction valeur en contrôle optimal ; catégorie log-exp dans le cas sous-Riemannien de Martinet. Phd Thesis, Université de Bourgogne, Dijon, 2000.
- [42] TRÉLAT (E.). — Asymptotics of accessibility sets along an abnormal trajectory, ESAIM/COCV, Vol. 6, 387-414, 2001.
- [43] TRÉLAT (E.). — Non subanalyticity of sub-Riemannian Martinet spheres, CRAS, t. 332, Série I, 527-532, 2001.
- [44] ZELENKO (I.), ZHITOMIRSKI (M.). — Rigid paths of generic 2-distributions on 3-manifolds, Duke Math. Journal, Vol. 79, No. 2, 281-307, 1995.
- [45] ZHITOMIRSKI (M.). — Typical singularities of differential 1-forms and pfaffian equations, Trans. of Math. Monographs, Vol. 113, AMS, 1992.