

Mémoires

de la SOCIÉTÉ MATHÉMATIQUE DE FRANCE

PERSISTENCE OF STRATIFICATIONS
OF NORMALLY EXPANDED
LAMINATIONS

Numéro 134
Nouvelle série

Pierre BERGER

2 0 1 3

SOCIÉTÉ MATHÉMATIQUE DE FRANCE
Publié avec le concours du Centre National de la Recherche Scientifique

Comité de rédaction

Jean BARGE
Gérard BESSON
Emmanuel BREUILLARD
Antoine CHAMBERT-LOIR
Jean-François DAT
Charles FAVRE

Daniel HUYBRECHTS
Yves LE JAN
Julien MARCHÉ
Laure SAINT-RAYMOND
Wilhelm SCHLAG

Raphaël KRIKORIAN (dir.)

Diffusion

Maison de la SMF
B.P. 67
13274 Marseille Cedex 9
France
smf@smf.univ-mrs.fr

AMS
P.O. Box 6248
Providence RI 02940
USA
www.ams.org

Tarifs 2013

Vente au numéro : 30 € (\$ 45)

Abonnement Europe : 262 €, hors Europe : 296 € (\$ 444)

Des conditions spéciales sont accordées aux membres de la SMF.

Secrétariat : Nathalie Christiaën

Mémoires de la SMF
Société Mathématique de France
Institut Henri Poincaré, 11, rue Pierre et Marie Curie
75231 Paris Cedex 05, France
Tél : (33) 01 44 27 67 99 • Fax : (33) 01 40 46 90 96
revues@smf.ens.fr • <http://smf.emath.fr/>

© Société Mathématique de France 2013

Tous droits réservés (article L 122-4 du Code de la propriété intellectuelle). Toute représentation ou reproduction intégrale ou partielle faite sans le consentement de l'éditeur est illicite. Cette représentation ou reproduction par quelque procédé que ce soit constituerait une contrefaçon sanctionnée par les articles L 335-2 et suivants du CPI.

ISSN 0249-633-X

ISBN 978-2-85629-767-4

Directeur de la publication : Marc PEIGNÉ

MÉMOIRES DE LA SMF 134

**PERSISTENCE OF STRATIFICATIONS
OF NORMALLY EXPANDED
LAMINATIONS**

Pierre Berger

Société Mathématique de France 2013
Publié avec le concours du Centre National de la Recherche Scientifique

Pierre Berger

CNRS-LAGA, UMR 7539, Université Paris 13,
99 avenue J.B. Clément 93430 Villetaneuse France.

E-mail : berger@math.univ-paris13.fr

Url : <http://www.ihes.fr/~pberger/>

Key words and phrases. — Laminations, Stratifications, Structural Stability, Persistence, Hyperbolic Dynamics, Endomorphisms, Axiom A, Product dynamics.

PERSISTENCE OF STRATIFICATIONS OF NORMALLY EXPANDED LAMINATIONS

Pierre Berger

Abstract. — This manuscript complements the Hirsch-Pugh-Shub (HPS) theory on persistence of normally hyperbolic laminations and implies several structural stability theorems.

We generalize the concept of lamination by defining a new object: the stratification of laminations. It is a stratification whose strata are laminations. The main theorem implies the persistence of some stratifications whose strata are normally expanded. The dynamics is a C^r -endomorphism of a manifold (which is possibly not invertible and with critical points). The persistence means that any C^r -perturbation of the dynamics preserves a C^r -close stratification.

If the stratification consists of a single stratum, the main theorem implies the persistence of normally expanded laminations by endomorphisms, and hence implies HPS theorem. Another application of this theorem is the persistence, as stratifications, of submanifolds with boundary or corners normally expanded. Several examples are also given in product dynamics.

As diffeomorphisms that satisfy axiom A and the strong transversality condition (AS) defines canonically two stratifications of laminations: the stratification whose strata are the (un)stable sets of basic pieces of the spectral decomposition. The main theorem implies the persistence of some “normally AS” laminations which are not normally hyperbolic and other structural stability theorems.

Résumé. — Ce travail s’inscrit dans le prolongement de celui de Hirsch-Pugh-Shub (HPS) sur la persistance des laminations normalement hyperboliques, et implique plusieurs théorèmes de stabilité structurelle.

On généralise le concept de lamination par une nouvelle catégorie d’objets : les stratifications de laminations. Il s’agit de stratifications, dont les strates sont des laminations. On propose alors un théorème assurant la persistance de certaines stratifications dont chaque strate est une lamination normalement dilatée. La dynamique est un C^r -endomorphisme d’une variété (qui n’est donc pas forcément inversible et qui peut avoir des points critiques). La persistance signifie que toute C^r -perturbation de la dynamique préserve une stratification C^r -proche.

Quand la stratification est formée d’une unique strate, le théorème principal donne la persistance des laminations normalement dilatées par un endomorphisme, et implique ainsi le théorème de HPS. Une autre application de ce théorème est la persistance des variétés à bord ou à coins normalement dilatés. Beaucoup d’exemples sont donnés facilement en dynamique produite.

Aussi les difféomorphismes vérifiant l’axiome A et la condition de transversalité forte (ATF) possèdent deux stratifications de laminations canoniques : celle dont les strates sont les ensembles stables (resp. instables) de ses pièces basiques. Ainsi, notre théorème implique la persistance de certaines laminations “normalement ATF” qui ne sont pas normalement hyperboliques et d’autres théorèmes de stabilité structurelle.

CONTENTS

Introduction	7
0.1. Motivations	7
0.2. Stratifications of normally expanded laminations	8
0.3. Structure of trellis of laminations and main result	12
0.4. Plan	14
1. Geometry of stratification of laminations	17
1.1. Laminations	17
1.2. Stratifications of laminations	21
1.3. Structures of trellis of laminations	26
2. Persistence of stratifications of laminations	39
2.1. Persistence of lamination	39
2.2. Main result on persistence of stratifications of laminations	45
2.3. A normally expanded but not persistent stratification	50
2.4. Consequences of the main result (theorem 2.2.11)	53
3. Proof of the persistence of stratifications	61
3.1. Preliminary	61
3.2. Proof to corollary 2.2.9	64
3.3. Fundamental property of dynamics on K_p	66
3.4. Fundamental property implies main theorem 2.2.11	67
3.5. Proof of fundamental property	68
3.6. Proof of lemma 3.5.7 and injectivity of $TS^0(f', i')$ in lemma 3.5.2	80
A. Analysis on laminations and on trellis	91
A.1. Partition of unity	91
A.2. Density of smooth liftings of a smooth map	97
B. Adapted metric	99

C. Plaque-expansiveness	103
C.1. Plaque-expansiveness in the diffeomorphism context	103
C.2. Plaque-expansiveness in the endomorphism context	104
D. Preservation of leaves and of laminations	107
Bibliography	111

INTRODUCTION

0.1. Motivations

In 1977, M. Hirsch, C. Pugh and M. Shub [15] developed a theory which has been very useful for hyperbolic dynamical systems. The central point of their work was to prove the C^r -persistence of manifolds, foliations, or more generally laminations which are r -normally hyperbolic and plaque-expansive, for all $r \geq 1$.

We recall that a lamination is *r -normally hyperbolic*, if the dynamics preserves the lamination (each leaf is sent into a leaf) and if the normal space to the leaves splits into two Tf -invariant subspaces, that Tf contracts (or expands) r -times more sharply than the tangent space to the leaves. Plaque expansiveness is a generalization⁽¹⁾ of expansiveness to the concept of laminations. The C^r -persistence of such a lamination means that for any C^r -perturbation of the dynamics, there exists a lamination, C^r -close to the first, which is preserved by the new dynamics, and such that the dynamics induced on the space of the leaves remains the same.

A direct application of this theory was the construction of an example of a robustly transitive diffeomorphism (every nearby diffeomorphism has a dense orbit) which is not Anosov. Then their work was used for example by C. Robinson [28] to prove the structural stability of C^1 -diffeomorphisms that satisfy axiom A and the strong transversality condition.

Nowadays, this theory remains very useful in several mathematical fields such as generic dynamical systems, differentiable dynamics, foliations theory or Lie group theory.

Nevertheless, this theory is not optimal from several viewpoints.

There are laminations which are not normally hyperbolic but are persistent. For example, let S be the 2-dimensional sphere and let N be a compact manifold. Let \mathcal{L} be the lamination structure on $N \times S$ whose leaves are the fibers of the canonical projection $N \times S \rightarrow S$. Let f be the north-south dynamics on S . Let F be the diffeomorphism on $N \times S$ equal to the product of the identity of N with f . One

1. For instance a normally hyperbolic lamination, whose leaves are the fibers of a bundle, is plaque-expansive.

can easily show that for any diffeomorphism F' close to F in the C^1 -topology, there exists a lamination structure \mathcal{L}' on $N \times S$ which is preserved by F' and is isomorphic to \mathcal{L} by a map close to the identity. Here the lamination \mathcal{L} is C^1 -persistent, but is not 1-normally hyperbolic.

Furthermore, in his thesis, M. Shub [30] has shown that for a manifold M and a C^1 -endomorphism f , every compact set K which is stable and expanded by f is then structurally stable (any C^1 -perturbation of f preserves a compact subset, homeomorphic and C^0 -close to K , such that via this homeomorphism the restriction of the dynamics to these compact sets are conjugate). By an endomorphism we mean a differentiable map, not necessarily bijective and possibly with some singularities.

Also, M. Viana [35] has used a persistent normally expanded lamination of (co-) dimension one to build a robustly non-uniformly expanding map. However, up to our knowledge, it has not been proved that a r -normally expanding and plaque-expansive lamination, by an endomorphism, is C^r -persistent. Yet, this result seems fundamental for the study of endomorphisms, and should be helpful in order to reduce the gap between the understanding of endomorphisms and of diffeomorphisms (structural stability, existence of new non-uniformly expanding maps, ...).

Finally, since Mañé's thesis [19], we know that a compact C^1 -submanifold is (1)-normally hyperbolic if and only if it is C^1 -persistent and uniformly locally maximal (*i.e.* there exists a neighborhood U of the submanifold N such that the maximal invariant subset in U of any C^1 -perturbation is a submanifold C^1 -close to N). However, a uniform locally maximal submanifold N can be persistent as a stratified space without being normally hyperbolic. For example, assume that a planar diffeomorphism has a hyperbolic fixed point P with a one-dimensional stable manifold X . We suppose that X without $\{P\}$ is contained in the repulsive basin of an expanding fixed point R whose eigenvalues have same modulus. The set \mathbb{S} , equal to the union of X and $\{R\}$, is homeomorphic to a circle. We may even define a stratification structure with X and $\{R\}$ as strata. One easily shows that for any C^1 -perturbation of the dynamics, there exists a hyperbolic fixed point P' close to P whose one-dimensional stable manifold X' punctured by P' belongs to the repulsive basin of a fixed point R' close to R . In particular, there is a stratification $(X', \{R'\})$ on $\mathbb{S}' := X' \cup \{R'\}$ which is preserved by the perturbation of the dynamics, such that X' is C^1 -close to X , $\{R'\}$ is close to $\{R\}$ and \mathbb{S}' is C^0 -close to \mathbb{S} .

For these reasons, it seems useful and natural to wonder about the persistence of stratifications of normally expanded laminations, in the endomorphism context. As the concept of stratification of laminations is new, we are going to define all the above terms. Then we will give several applications of the main theorem of this work. At the end of this introduction, we will formulate a more transparent special case of the main theorem suitable for most of the presented applications.

0.2. Stratifications of normally expanded laminations

We recall that a lamination is a second-countable metric space L locally modeled (via compatible charts) on the product of \mathbb{R}^d with a locally compact space. The maximal set of compatible charts is denoted by \mathcal{L} .

Let (L, \mathcal{L}) be a lamination C^r -embedded into a Riemannian manifold M , with $r \geq 1$. Let f be a C^r -endomorphism of M , *preserving* (L, \mathcal{L}) : f sends each leaf of \mathcal{L} into a leaf of \mathcal{L} . Let $T\mathcal{L}$ be the subbundle of $TM|L$ whose fibers are the tangent spaces to the leaves of \mathcal{L} . We say that f *r -normally expands* (L, \mathcal{L}) if there exist $\lambda > 1$ and a continuous positive function C on L such that for any $x \in L$, any unitary vectors $v_0 \in T_x\mathcal{L}$ and $v_1 \in (T_x\mathcal{L})^\perp$, any $n \geq 0$, we have

$$\|p \circ Tf^n(v_1)\| \geq C(x) \cdot \lambda^n \cdot (1 + \|Tf^n(v_0)\|^r),$$

with p the orthogonal projection of $TM|L$ onto $T\mathcal{L}^\perp$.

When L is compact, it is consistent with the usual definitions of normal expansion by replacing C with its minimum.

A first result is:

THEOREM 0.2.1. — *Let (L, \mathcal{L}) be a lamination C^r -embedded into a Riemannian manifold M . Let f be a C^r -endomorphism of M which is r -normally expanding and plaque-expansive at (L, \mathcal{L}) . Let L' be a precompact open subset of L whose closure is sent by f into L' . Then the lamination structure induced by (L, \mathcal{L}) on L' is C^r -persistent.*

In particular, this theorem implies the C^r -persistence of compact r -normally expanded and plaque-expansive laminations. Actually, this theorem is a particular case of the main theorem. A direct proof of theorem is given in [5].

Let us define the stratifications of laminations.

Following J. Mather [21], a *stratified space* is the data of a second countable metric space A with a locally finite partition Σ of A into locally closed subsets, satisfying the axiom of the frontier:

$$\forall (X, Y) \in \Sigma^2, \text{cl}(X) \cap Y \neq \emptyset \implies \text{cl}(X) \supset Y.$$

The pair (A, Σ) is called *stratified space* with *support* A and *stratification* Σ .

Following H. Whitney, R. Thom or J. Mather, we can endow a stratified space with a geometric structure. In such a way, we define a *laminar* structure on (A, Σ) as a lamination structure on each stratum, such that if the closure of a stratum X intersects a stratum Y , then the dimension of X is at least equal to the dimension of Y . Then Σ is called a *stratification of laminations*. A (*stratified*) C^r -*embedding* of this space into a manifold M is a homeomorphism onto its image such that, its restriction to each stratum X is a C^r -embedding of the lamination X into M . We often identify the stratified space (A, Σ) with its image by the embedding i .

EXAMPLE 0.2.2. — A Whitney's stratification is a laminar stratification whose strata are single leaves.

EXAMPLE 0.2.3. — Let f be an endomorphism of a manifold M . Let K be a compact subset of M , f -invariant ($f^{-1}(K) = K$), nowhere dense and expanded. Then K endowed with its 0-dimensional lamination structure and $M \setminus K$ endowed with its manifold structure form a stratification of normally expanded laminations on M . This example will be useful for many results.

EXAMPLE 0.2.4. — Given a diffeomorphism that satisfies axiom A and the strong transversality condition, if we denote by $(\Lambda_i)_i$ the basic sets and $X_i := W^s(\Lambda_i)$ the canonical lamination on the stable set of each Λ_i (whose leaves are stable manifolds), then the partition $(X_i)_i$ is a stratification of normally expanded laminations.

Given a manifold M , a stratification of laminations Σ on $A \subset M$ and an endomorphism f of M , we say that f *preserves* (A, Σ) if f preserves each stratum $X \in \Sigma$, as a lamination.

A stratification of laminations (A, Σ) preserved by $f \in \text{End}^r(M)$ is C^r -*persistent*, if for any endomorphism f' C^r -close to f , there exists a stratified embedding i' of (A, Σ) into M which is C^r -close to the canonical inclusion and such that f' preserves the stratification (A, Σ) embedded by i' , and for each stratum $X \in \Sigma$, every point $i'(x) \in i'(X)$ is sent by f' into the image by i' of a small plaque of X which contains $f(x)$.

The aim of this memoir is to present and prove a general theorem providing, for any $r \geq 1$, the C^r -persistence of stratifications of r -normally expanded laminations, under some extra geometric conditions.

Let us illustrate by some applications of the main theorem on persistence of stratifications of laminations.

0.2.1. Submanifolds with boundary

THEOREM 0.2.5. — *Let (M, g) be a Riemannian manifold and let N be a compact submanifold with boundary of M . Let $r \geq 1$. Let f be an endomorphism of M which preserves and r -normally expands the boundary ∂N and the interior $\overset{\circ}{N}$ of N . Then the stratification $(\overset{\circ}{N}, \partial N)$ on N is C^r -persistent. In other words, for any endomorphism f' C^r -close to f , there exist two submanifolds $\partial N'$ and $\overset{\circ}{N}'$ such that:*

- ▷ $\overset{\circ}{N}'$ (resp. $\partial N'$) is preserved by f' , diffeomorphic and C^r -close to $\overset{\circ}{N}$ (resp. ∂N) for the compact-open topology;
- ▷ the pair $(\overset{\circ}{N}', \partial N')$ is a stratification (of laminations) on $N' := \overset{\circ}{N}' \cup \partial N'$;
- ▷ the set N' is the image of N by an embedding C^0 -close to the canonical inclusion of N into M .

REMARK 0.2.6. — Usually, N' is not a submanifold with boundary.

Let us generalize the above result to a larger context.

0.2.2. **Submanifolds with corners.** — We recall that a compact manifold with corner N is a differentiable manifold modeled on \mathbb{R}_+^d . We denote by $\partial^{0k}N$ the set of points of N which, seen in a chart, have exactly k coordinates equal to zero. The pair $(N, \Sigma := \{\partial^{0k}N\})$ is a stratified space.

THEOREM 0.2.7. — *Let i be a C^r -embedding of N into a Riemannian manifold (M, g) . Let $r \geq 1$. Let f be a C^r -endomorphism of N , which preserves and r -normally expands each stratum $\partial^{0k}N$. Then the stratification Σ on N is stable for C^r -perturbations of f . In other words, for every endomorphism f' C^r -close to f , there exist submanifolds $(\partial^{0k}N')_k$ such that:*

- ▷ for each k , $\partial^{0_k} N'$ is preserved by f' , is diffeomorphic and close to $\partial^{0_k} N$ in the C^r -compact-open topology,
- ▷ the family $(\partial^{0_k} N')_k$ is a stratification (of laminations) on

$$N' := \bigcup_k \partial^{0_k} N';$$

- ▷ the set N' is the image of N by an embedding C^0 -close to the canonical inclusion of N into M .

The last theorem is not an obvious consequence of the main theorem. The application is chosen in details in [6].

The main theorem easily provides the persistence of many stratifications of normally expanded laminations in product dynamics, as in the following examples.

0.2.3. Invariant laminations of the Viana map in $\mathbb{C} \times \mathbb{R}$

Let

$$V : \mathbb{C} \times \mathbb{R} \longrightarrow \mathbb{C} \times \mathbb{R}, \quad (z, h) \longmapsto (z^4, h^2 + c).$$

The map $z \mapsto z^4$ expands the unit circle \mathbb{S}^1 and preserves the interior of the unit disk \mathbb{D} . We endow \mathbb{S}^1 and \mathbb{D} with the lamination structures of dimension 0 and 2 respectively.

Let $c \in]-2, \frac{1}{4}[$, then the map $h \mapsto h^2 + c$ sends an open interval I into it self and expands its boundary ∂I .

We stratify the filled cylinder $C := \text{cl}(\mathbb{D} \times I)$ by the laminations:

- ▷ $X_0 := \mathbb{S}^1 \times \partial I$ of dimension 0;
- ▷ $X_1 := \mathbb{S}^1 \times I$ of dimension 1, whose leaves are $(\{\alpha\} \times I)_{\alpha \in \mathbb{S}^1}$;
- ▷ $X_2 := \mathbb{D} \times \partial I$ of dimension 2;
- ▷ $X_3 := \mathbb{D} \times I$ of dimension 3.

Let Σ be the stratification of laminations on C defined by these strata. We notice that V preserves and 1-normally expands this stratification.

The persistence of this stratification, for C^1 -perturbations of V , follows from the main theorem.

In other words, for every endomorphism V' C^1 -close to V , there exists a homeomorphism i' of C onto its image in $\mathbb{C} \times \mathbb{R}$, C^0 -close to the canonical inclusion such that for each stratum $X_k \in \Sigma$:

- ▷ the restriction $i'|X_k$ is an embedding of lamination, C^1 -close to the canonical inclusion of X_k in $\mathbb{C} \times \mathbb{R}$; in particular i' is continuously leafwise differentiable;
- ▷ the lamination $i'(X_k)$ is preserved by V' , and for $x \in X_k$, $V' \circ i'(x)$ belongs to the image by i' of a small plaque of X_k containing $V(x)$.

0.2.4. Products of hyperbolic rational functions

Let

$$f : \widehat{\mathbb{C}}^n \longrightarrow \widehat{\mathbb{C}}^n, \quad (z_i)_i \longmapsto (R_i(z_i))_i.$$

We assume that for each i , R_i is a hyperbolic rational function of the Riemann sphere $\widehat{\mathbb{C}}$. It follows that its Julia set K_i is expanded and the complement X_i of K_i in $\widehat{\mathbb{C}}$ is the union of attraction basins of the attracting periodic orbits.

Let Σ be the stratification of laminations on $\widehat{\mathbb{C}}^n$ formed by the strata $(Y_J)_{J \subset \{1, \dots, n\}}$, Y_J being of real dimension twice the cardinal of J and with support:

$$Y_k = \prod_{j \in J} X_j \times \prod_{j \in J^c} K_j.$$

The leaves of Y_J are in the form $\prod_{j \in J} C_j \times \prod_{j \in J^c} \{k_j\}$, with C_j a connected component of $\widehat{\mathbb{C}} \setminus K_j$ and k_j a point of K_j .

The stratification of laminations Σ is r -normally expanded, for every $r \geq 1$. The C^r -persistence of Σ follows from the main theorem.

A similar result exists on \mathbb{R}^n for products of real hyperbolic polynomial functions.

0.3. Structure of trellis of laminations and main result

We construct, in section 2.3, a very simple example of a stratification of normally expanded laminations which is not persistent. Therefore, some new conditions are necessary to imply the persistence of stratifications of laminations.

The hypotheses of the main result on persistence of stratified space (A, Σ) require the existence of a *tubular neighborhood* (L_X, \mathcal{L}_X) for each stratum $X \in \Sigma$: this is a lamination structure \mathcal{L}_X on an open neighborhood L_X of X in A , such that each leaf of X is a leaf of \mathcal{L}_X .

Existence of a similar structure was already conjectured in a local way by H. Whitney [36] in the study of analytic varieties. It was also a key ingredient in the proofs by W. de Melo [22] and by C. Robinson [28] of the structural stability of diffeomorphisms that satisfy axiom A and the strong transversality condition defined in example 0.2.4.

A C^r -*trellis (of laminations)* on a laminar stratified space (A, Σ) is a family of tubular neighborhoods $\mathcal{T} = (L_X, \mathcal{L}_X)_{X \in \Sigma}$ such that for all strata $X \leq Y$:

- ▷ each plaque P of \mathcal{L}_Y included in L_X is C^r -foliated by plaques of \mathcal{L}_X ;
- ▷ every \mathcal{L}_Y -plaque $P' \subset L_X$ close to the same plaque P has its foliation by \mathcal{L}_X -plaques diffeomorphic and C^r -close to the one of P .

EXAMPLE 0.3.1. — The stratification in example 0.2.3 admits a trellis structure. Let L_K be a neighborhood of K in M endowed with the 0-dimensional lamination structure \mathcal{L}_K . Then $((L_K, \mathcal{L}_K), X)$ is a trellis structure on $(M, (K, X))$.

EXAMPLE 0.3.2. — The canonical stratification $(\partial N, \overset{\circ}{N})$ of a manifold with boundary N admits a trellis structure: Let $\mathcal{L}_{\partial N}$ be the lamination structure on a small neighborhood $L_{\partial N}$ of the boundary ∂N whose leaves are the subset of points in N equidistant to the boundary. Then $((L_{\partial N}, \mathcal{L}_{\partial N}), \overset{\circ}{N})$ is a trellis structure on $(N, (\partial N, \overset{\circ}{N}))$.

A C^r -embedding i of (A, Σ) into a manifold M is \mathcal{T} -controlled if i is a homeomorphism onto its image and the restriction of i to L_X is a C^r -embedding of the lamination \mathcal{L}_X , for every $X \in \Sigma$.

We can now formulate a special case of the main theorem:

THEOREM 0.3.3. — *Let $r \geq 1$ and let (A, Σ) be a compact stratified space supporting a C^r -trellis structure \mathcal{T} . Let i be a \mathcal{T} -controlled C^r -embedding of (A, Σ) into a manifold M . We identify A, Σ and \mathcal{T} with their images in M . Let f be a C^r -endomorphism of M preserving Σ and satisfying for each stratum X :*

- (i) f r -normally expands X and is plaque-expansive at X .

There exists a neighborhood V_X of X in L_X such that:

- (ii) *each plaque of \mathcal{L}_X included in V_X is sent by f into a leaf of \mathcal{L}_X ;*
- (iii) *there exists $\epsilon > 0$, such that every ϵ -pseudo-orbit⁽²⁾ of V_X which respects \mathcal{L}_X is included in X .*

Then for f' C^r -close to f , there exists a \mathcal{T} -controlled embedding i' , close to i , such that for the identification of A, Σ and \mathcal{T} via i' , properties (i), (ii) and (iii) hold with f' . Moreover, for each stratum $X \in \Sigma$, each point $i'(x) \in i'(X)$ is sent by f' into the image by i' of a small X -plaque of x containing $f(x)$. In particular, the stratification of laminations Σ is C^r -persistent.

REMARK 0.3.4. — This result has also a version which allows A to be non-compact and/or i to be an immersion. In the immersion case, the plaque-expansiveness condition is not required.

REMARK 0.3.5. — We have also a better conclusion: for every stratum X there exists a neighborhood V'_X of X in \mathcal{L}_X such that, for every f' C^r -close to f , each point $i'(x) \in i'(V'_X)$ is sent by f' into the image by i' of a small plaque of \mathcal{L}_X containing $f(x)$.

The main difficulty to apply this theorem is to build a trellis structure that satisfies (ii).

Nevertheless, thanks to the formalism, the following proposition provides many trellis structures which imply the persistence of these stratifications, via the main result.

2. An ϵ -pseudo-orbit $(x_n)_n \in V'_X$ respects \mathcal{L}_X , if for all $n \geq 0$, the points $f(x_n)$ and x_{n+1} belong to a same plaque of \mathcal{L}_X of diameter less than ϵ .

PROPOSITION 0.3.6. — For $r \geq 1$, let (A, Σ) and (A', Σ') be compact stratified spaces endowed with C^r -trellis structures \mathcal{T} and \mathcal{T}' respectively. Let i and i' be C^r -embeddings \mathcal{T} and \mathcal{T}' -controlled of (A, Σ) and (A', Σ') into manifolds M and M' respectively. Let $f \in \text{End}^r(M)$ and $f' \in \text{End}^r(M')$ satisfying properties (i), (ii) and (iii) of theorem 0.3.3.

Then the partition $\Sigma \times \Sigma'$ on $A \times A'$, whose elements are the products of a stratum of Σ with a stratum of Σ' , is a stratification of laminations which is preserved by the product dynamics (f, f') of $M \times M'$. Moreover, if (f, f') r -normally expands this stratification, then properties (i), (ii), and (iii) are satisfied for (f, f') and $\Sigma \times \Sigma'$. In particular this last stratification is C^r -persistent.

For instance, by using this proposition and example 0.3.1, we get the proof of the persistence of examples 0.2.3 and 0.2.4.

Remark 0.3.5 was not useful for the aforementioned applications. However it is useful to prove theorems on structural stability or persistence of laminations which are not hyperbolic. For example, we needed this remark, together with a trellis structure built by de Melo on the stratification of laminations defined in example 0.2.4, to show the following:

THEOREM 0.3.7. — Let s be a C^1 -submersion of a compact manifold M onto a compact surface S . Let \mathcal{L} be the lamination structure on M whose leaves are the connected components of the fibers of s . Let f be a diffeomorphism of M which preserves the lamination \mathcal{L} . Let $f_b \in \text{Diff}^1(S)$ be the dynamics induced by f on the leaves space of \mathcal{L} . We suppose that:

- f_b satisfies axiom A and the strong transversality condition,
- the \mathcal{L} -saturated subset generated by the non-wandering set of f in M is 1-normally hyperbolic.

Then \mathcal{L} is C^1 -persistent.

Such a result is actually generalized to AS bundles whose bases are “AS compact subset” of a surface [4].

This memoir is the main part of my PhD thesis under the direction of J.-C. Yoccoz. I would like to thank him for his guidance. I would like to thank also C. Bonatti, M. Viana, P. Pansu, E. Pujal, F. Paulin, C. Murolo, and D. Trotman for many discussions. I am grateful to the anonymous referee for many valuable suggestions and corrections. Finally, I thank P.-Y. Fave for drawing Figures 3, 4 and 5 of this memoir.

0.4. Plan

The first chapter is mostly geometric. We introduce the definitions and the terminologies necessary for all the other chapters.

In the first section of this chapter, we recall the definitions of laminations, their morphisms and the topologies on these spaces.

In the second section of this chapter, we introduce the stratification of laminations. We present how they are related to other kinds of stratifications (analytic and differentiable) and we show some simple properties of them. Then this section proves that the diffeomorphisms satisfying axiom A and the strong transversality condition define canonically two stratifications of laminations. At the end of this section, we define stratified morphisms and endow the space of morphisms with a topology.

In the third section of this chapter, we introduce the trellis of laminations structure. Then we define the morphisms of this structure and endow the space of morphisms with a topology. Finally, in this chapter, we show how the trellis structure are linked to other works in dynamical system, differentiable geometry or analytic geometry.

The second chapter explains the main result on persistence of stratifications of normally expanded laminations.

In the first section, we restrict the study to the laminations. First, we define the preservation and persistence of laminations, embedded or immersed. Then we define the r -normal expansion of an immersed or embedded lamination and gives some related properties. Finally, in this section, we state theorem 2.1.10 on C^r -persistence of r -normally expanded immersed laminations. After defining the plaque-expansiveness, we give corollary 2.1.18 on C^r -persistence of r -normally and plaque-expansive embedded laminations. Both are the restrictions of main theorem 2.2.11 and its corollary 2.2.9, to the case where the stratification consists of a unique stratum.

The second section of this chapter contains the main result. First, we define the preservation and the persistence of stratifications of laminations, embedded or immersed. Then it presents main theorem 2.2.11 via its corollaries 2.2.2, 2.2.9, and some easy applications.

In the third section, we motive the geometrical hypotheses of the main theorem on persistence of stratifications of laminations, by giving a counter example of a compact, normally expanded stratification which is not persistent and does not admit a trellis structure.

The fourth section provides some applications of the main result. We begin by giving the statement of the result on the persistence of normally expanded submanifolds with boundary or corners as stratifications. The full proof of this application is in [6]. Then we give an extension of Shub's theorem on conjugacy of repulsive compact set. Further, we show proposition 0.3.6 which implies some examples of persistent stratifications of laminations in product dynamics. Finally, we state a conjecture on the persistent of "normally AS laminations". A partial case is the persistence of AS bundle over a surface. Although this result is a consequence of the main theorem, we prove it in [4].

The third chapter is the proof of the main result. Appendix A provides some analysis results needed in this work. Appendix B consists of the proof of the existence of an adapted metric to the normal expansion of a lamination by an endomorphism. In Appendix C, we adapt and develop some results on the plaque-expansiveness to the endomorphism context. In Appendix D, a negative answer to a question of Hirsch-Pugh-Shub about preservation of immersed laminations. This justifies how we defined the preservation of a lamination.

CHAPTER 1

GEOMETRY OF STRATIFICATION OF LAMINATIONS

In this chapter, we introduce the laminar stratified space. The laminar stratified space is a natural generalization of laminations and stratifications. We know that laminations and stratifications occur in dynamical system as persistent and preserved structures (as in Hirsch-Pugh-Shub theory or in Morse-Smale theory).

We will state and illustrate the main result on persistence of stratification of laminations in chapter 2. In this chapter, we only deal with the geometry of this structure, recalling or defining some definitions and properties.

Throughout this chapter we denote by r a positive integer or the symbol ∞ .

1.1. Laminations

1.1.1. Definitions. — Let us consider a locally compact and second-countable metric space L covered by open sets $(U_i)_i$, called *distinguished open sets*, endowed with homeomorphisms h_i from U_i onto $V_i \times T_i$, where V_i is an open set of \mathbb{R}^d and T_i is a metric space.

We say that the *charts* $(U_i, h_i)_i$ define a C^r -*atlas* of a lamination structure on L of dimension d if the *coordinate changes* $h_{ij} = h_j \circ h_i^{-1}$ can be written in the form

$$h_{ij}(x, t) = (\phi_{ij}(x, t), \psi_{ij}(x, t)),$$

where ϕ_{ij} takes its values in \mathbb{R}^d , the partial derivatives $(\partial_x^s \phi_{ij})_{s=1}^r$ exist and are continuous on the domain of ϕ_{ij} , and $\psi_{ij}(\cdot, t)$ is locally constant for any t .

Two C^r -atlases are *equivalent* if their union is a C^r -atlas.

A (C^r) -*lamination* is a metric space L endowed with a maximal C^r -atlas \mathcal{L} .

A *plaque* is a subset of L which can be written in the form $h_i^{-1}(V_i^0 \times \{t\})$, for a chart h_i and a connected component V_i^0 of V_i . A plaque that contains a point $x \in L$ will be denoted by \mathcal{L}_x ; the union of the plaques containing x and of diameter less than $\epsilon > 0$ will be denoted by \mathcal{L}_x^ϵ . Given any compact K of L , for ϵ small enough, \mathcal{L}_x^ϵ is homeomorphic to an Euclidean ball, for every $x \in K$. The *leaves* of \mathcal{L} are the smallest subsets of L which contain any plaque that intersects them.

We say that a subset P of L is *saturated* if it is a union of leaves.

If moreover it is a locally compact subset, this subset is \mathcal{L} -admissible. Then the charts (U_i, ϕ_i) of \mathcal{L} restricted to $U_i \cap P$ define a lamination structure on P . We will call this structure *the restriction of \mathcal{L} to P* and we denote this structure by $\mathcal{L}|P$.

Similarly, if V is an open subset of L , the set of the charts $(U, \phi) \in \mathcal{L}$ such that $U \subset V$ forms a lamination structure on V , which is denoted by $\mathcal{L}|V$.

A subset P of L which is $\mathcal{L}|V$ -admissible for a certain open subset V of L will be called *\mathcal{L} -locally admissible*, and we will denote by $\mathcal{L}|P$ the lamination structure $\mathcal{L}|V|P$.

We recall that the locally compact subsets of a locally compact metric space are the intersections of open and closed subsets.

EXAMPLES 1.1.1

- A manifold of dimension d is a lamination of the same dimension.
- A C^r -foliation on a connected manifold induces a C^r -lamination structure.
- A locally compact and second-countable metric space defines a lamination of dimension zero.
- If K is a locally compact subset of \mathbb{S}^1 , then the manifold structure of the circle \mathbb{S}^1 induces on $\mathbb{S}^1 \times K$ a C^∞ -lamination structure whose leaves are $\mathbb{S}^1 \times \{k\}$, for $k \in K$.
- The stable foliation of an Anosov C^r -diffeomorphism induces a C^r -lamination structure whose leaves are the stable manifolds.
- Let M be the cylinder $\mathbb{S}^1 \times \mathbb{R}$. Let π be the canonical projection of \mathbb{R} onto $\mathbb{S}^1 \cong \mathbb{R}/\mathbb{Z}$. Let

$$L := \{(\theta, y) \in M : y = \arctan(\bar{\theta}), \pi(\bar{\theta}) = \theta\} \cup \mathbb{S}^1 \times \{-\frac{1}{2}\pi, \frac{1}{2}\pi\}.$$

The compact space L is canonically endowed with a 1-dimensional lamination structure which consists of the leaves $\mathbb{S}^1 \times \{-\frac{1}{2}\pi\}$, $\mathbb{S}^1 \times \{\frac{1}{2}\pi\}$, and a last one which spirals down to these two circles.

PROPERTY 1.1.2. — *If (L, \mathcal{L}) and (L', \mathcal{L}') are two laminations, then $L \times L'$ is endowed with the lamination structure whose leaves are the product of the leaves of (L, \mathcal{L}) with the leaves of (L', \mathcal{L}') . We denote this structure by $\mathcal{L} \times \mathcal{L}'$.*

PROPERTY 1.1.3. — *If \mathcal{L} and \mathcal{L}' are two lamination structures on two open subsets L and L' of a metric space A such that the atlases $\mathcal{L}|L \cap L'$ and $\mathcal{L}'|L \cap L'$ are equivalent, then the union of the atlases \mathcal{L} and \mathcal{L}' is an atlas on $L \cup L'$.*

1.1.2. Morphisms of laminations. — A map f is a C^r -morphism (of laminations) from (L, \mathcal{L}) to (L', \mathcal{L}') if it is a continuous map from L to L' such that, seen via charts h and h' , it can be written in the form:

$$h' \circ f \circ h^{-1}(x, t) = (\phi(x, t), \psi(x, t))$$

where ϕ takes its values in $\mathbb{R}^{d'}$, $\partial_x^s \phi$ exists, is continuous on the domain of ϕ , for all $s \in \{1, \dots, r\}$ and $\psi(\cdot, t)$ is locally constant.

If, moreover, the linear map $\partial_x \phi(x, t)$ is always one-to-one, then the morphism f is an *immersion (of laminations)*.

An *embedding (of laminations)* is an immersion which is a homeomorphism onto its image.

The *endomorphisms of (L, \mathcal{L})* are the morphisms from (L, \mathcal{L}) into itself.

We denote by:

- $\text{Mor}^r(\mathcal{L}, \mathcal{L}')$ the set of the C^r -morphisms from \mathcal{L} into \mathcal{L}' ;
- $\text{Im}^r(\mathcal{L}, \mathcal{L}')$ the set of the C^r -immersions from \mathcal{L} into \mathcal{L}' ;
- $\text{Emb}^r(\mathcal{L}, \mathcal{L}')$ the set of the C^r -embeddings from \mathcal{L} into \mathcal{L}' ;
- $\text{End}^r(\mathcal{L})$ the set of the C^r -endomorphisms of \mathcal{L} .

We denote by $T\mathcal{L}$ the vector bundle over L , whose fiber at $x \in L$, denoted by $T_x\mathcal{L}$, is the tangent space at x to its leaf. If f is a morphism from \mathcal{L} into \mathcal{L}' , we denote by Tf the bundle morphism from $T\mathcal{L}$ to $T\mathcal{L}'$ over f induced by the differential of f along the leaves of \mathcal{L} .

REMARK 1.1.4. — If M is a manifold, we notice that $\text{End}^r(M)$ denotes the set of C^r -maps from M into itself, possibly non-bijective and possibly with singularities.

EXAMPLE 1.1.5. — Let f be a C^r -diffeomorphism of a manifold M and let K be hyperbolic compact subset of M . We suppose that K is endowed with a local product structure: there exists $\epsilon > 0$ such that for $x, y \in K$ nearby the local unstable manifold $W_\epsilon^u(x)$ intersects $W_\epsilon^s(y)$ transversally at a unique point $[x, y]$.

Then the union $W^s(K)$ of stable manifold of points in K is the image of a canonical C^r -lamination (L, \mathcal{L}) immersed injectively. Moreover if every stable manifold does not accumulate on K , then (L, \mathcal{L}) is a C^r -embedded lamination.

Proof. — We endow M with an adapted metric d_M to the hyperbolic compact set K . For small $\epsilon > 0$, we recall that $W_\epsilon^s(x)$ is equal to the set of points whose trajectory is ϵ -distant to the trajectory of $x \in K$. Let

$$W_\epsilon^s(K) := \bigcup_{x \in K} W_\epsilon^s(x).$$

For ϵ small enough, the closure of $W_\epsilon^s(K)$ is sent by f into $W_\epsilon^s(K)$.

For $\epsilon > 0$ small enough, for every $x \in K$, there exists a continuous family of embeddings $(p_y)_{y \in T}$ from $W_\epsilon^s(x)$ onto $W_\epsilon^s(y)$, where $T := W_\epsilon^u(x) \cap K$. From the local product structure, the following map is a homeomorphism onto a neighborhood U of x :

$$W_\epsilon^s(x) \times T \longrightarrow U.$$

Also its inverse is a chart of the canonical C^r -lamination structure \mathcal{L}_0 on $W_\epsilon^s(K)$.

Let C be the subset $W_\epsilon^s(K) \setminus f^2(\text{cl}(W_\epsilon^s(K)))$. For $i > 0$, we denote by C_i the set $f^{-i}(C)$ and by C_0 the set $W_\epsilon^s(K)$. The union $\bigcup_{n \geq 0} C_n$ is consequently equal to $W^s(K)$. Moreover, for $k, \ell \geq 0$, if C_k intersects C_ℓ then $|k - \ell| \leq 1$.

Let us now construct a metric on $W^s(K)$ such that $(C_n)_n$ is an open covering and such that the topology induced by this metric on C_n is the same than the one of M . For $(x, y) \in W^s(K)^2$, we denote

$$(x, y) := \inf \left\{ \sum_{i=1}^{n-1} d_M(x_i, x_{i+1}); n > 0, (x_i)_i \in W^s(K)^n, \text{ such} \right. \\ \left. \text{that } x_1 = x, x_n = y, \forall i, \exists j : (x_i, x_{i+1}) \in C_j^2 \right\}.$$

We remark that d is a distance with announced properties. The metric space L is therefore $W^s(K)$ endowed with this distance. We remark that if every stable manifold does not accumulate on K , then the topology on L induced by this metric and the metric of M are the same. In other words \mathcal{L} is embedded.

For $i > 0$, the open subset C_i supports the C^r -lamination structure \mathcal{L}_i whose charts are the composition of the charts of $\mathcal{L}_0|C$ with f^i . As f is a diffeomorphism, for any i, j , the restriction of \mathcal{L}_i and \mathcal{L}_j to $C_i \cap C_j$ are equivalent. By property 1.1.3, the structures $(\mathcal{L}_i)_{i \geq 0}$ generate a C^r -lamination structure \mathcal{L} on L . \square

1.1.3. Riemannian metric on a lamination. — A *Riemannian metric* g on a C^r -lamination (L, \mathcal{L}) is an inner product g_x on each fiber $T_x \mathcal{L}$ of $T\mathcal{L}$, which depends C^{r-1} -continuously on the base point x . It follows from the existence of partitions of unity (see proposition A.1.2) that any lamination (L, \mathcal{L}) can be endowed with a certain Riemannian metric. ⁽¹⁾

A Riemannian metric induces — in a standard way — a metric on each leaf. For two points x and y which belong to a same leaf, the distance between x and y is defined by:

$$d_g(x, y) = \inf_{\substack{\gamma \in \text{Mor}([0,1], \mathcal{L}); \\ \gamma(0)=x, \gamma(1)=y}} \int_0^1 \sqrt{g(\partial_t \gamma(t), \partial_t \gamma(t))} dt.$$

1.1.4. Equivalent classes of morphisms. — We will say that two morphisms f and f' in $\text{Mor}^r(\mathcal{L}, \mathcal{L}')$ (resp. $\text{Im}^r(\mathcal{L}, \mathcal{L}')$ and $\text{End}^r(\mathcal{L})$) are equivalent if for every $x \in L$, the points $f'(x)$ and $f(x)$ belong to a same leaf of \mathcal{L}' . The equivalence class of f will be denoted by $\text{Mor}_f^r(\mathcal{L}, \mathcal{L}')$ (resp. $\text{Im}_f^r(\mathcal{L}, \mathcal{L}')$ and $\text{End}_f^r(\mathcal{L})$).

Given a Riemannian metric g on (L', \mathcal{L}') , we endow the equivalence classes with the C^r compact-open topology. Let us describe elementary open sets which generate the topology.

Let K be a compact subset of L such that K and $f(K)$ are included in distinguished open subsets endowed with charts (h, U) and (h', U') . We define (ϕ, ψ) by $h' \circ f \circ h^{-1} = (\phi, \psi)$ on $h(K)$.

1. As the tangent bundle is only continuous when $r = 1$, we cannot define the geodesic flow along the leaves. Nevertheless, there exists a C^∞ -lamination structure, compatible with the C^1 -structure. For such a structure, we can define the geodesic flow for another regular metric. To show it we can adapt the proof of theorem 2.9 in [16] with the analysis techniques of Appendix A.1.1.

Let $\epsilon > 0$. The following subset is an elementary open set of the topology:

$$\Omega := \left\{ f' \in \text{Mor}_f^r(\mathcal{L}, \mathcal{L}') : f'(K) \subset U', \text{ and s.t. if } \phi' \text{ is defined by} \right. \\ \left. h' \circ f' \circ h^{-1} = (\phi', \psi), \text{ we have } \max_{h(K)} \left(\sum_{s=1}^r \|\partial_x^s \phi - \partial_x^s \phi'\| \right) < \epsilon \right\}.$$

For any manifold M , each space $\text{Im}^r(\mathcal{L}, M)$, $\text{Emb}^r(\mathcal{L}, M)$ and $\text{End}^r(M)$ contains a unique equivalence class. We endow these spaces with the topology of their unique equivalence class.

In particular the topology on $C^r(M, M) = \text{End}^r(M)$ is the (classical) C^r -compact-open topology.

Given a lamination (L, \mathcal{L}) C^r -immersed by i into a Riemannian manifold (M, g) , we define the C^r -strong topology on $\text{Im}^r(\mathcal{L}, M)$ by the following (partially defined) distance:

$$\forall (j, j') \in \text{Im}^r(\mathcal{L}, M), \quad d(j, j') := \sup_{\substack{(x, u) \in T\mathcal{L} \\ \|u\|=1}} \sum_{s=1}^r d(\partial_{T_x \mathcal{L}}^s j(u^s), \partial_{T_x \mathcal{L}}^s j'(u^s)),$$

where (L, \mathcal{L}) is endowed with the Riemannian distance i^*g and TM is endowed with the Riemannian distance induced by g .

1.2. Stratifications of laminations

Throughout this section, all laminations are supposed of class C^r .

1.2.1. Stratifications. — The concept of stratification occurs in several mathematical fields. Its definition depends on the fields and on the authors. One of the most general definitions was formulated by J. Mather [21]⁽²⁾:

DEFINITION 1.2.1. — A *stratification* of a metric space A is a partition of A into subsets, called *strata*, that satisfy the following conditions:

- 1) each stratum is locally closed, *i.e.*, it is equal to the intersection of a closed subset with an open subset of A ;
- 2) the partition Σ is locally finite;
- 3) (condition of frontier) for any pair of strata $(X, Y) \in \Sigma^2$ satisfying $Y \cap \text{cl}(X) \neq \emptyset$, we have $Y \subset \text{cl}(X)$. We write $Y \leq X$ and X is said *incident* to Y .

The pair $\chi = (A, \Sigma)$ is called the *stratified space of support A and of stratification Σ* .

PROPERTY 1.2.2. — *The stratification equipped with the relation \leq is a partially ordered set.*

2. In this article, the object of the definition is called a *prestratification*. This corresponds in fact to the stratifications defined here.

Proof. — The reflexivity and the transitivity are clear. To show the antisymmetry, we choose two strata $(X, Y) \in \Sigma$ such that $X \leq Y$ and $Y \leq X$. This means that $X \subset \text{cl}(Y)$ and $Y \subset \text{cl}(X)$, hence $\text{cl}(X)$ is equal to $\text{cl}(Y)$. As X and Y are locally closed, these two strata cannot be disjoint and as Σ is a partition of A , these two strata are equal. \square

1.2.2. Analytic and differentiable stratifications. — Among the fields involving stratifications, we can mention analytic geometry and differential geometry. Let us precise the definitions of stratifications for both of these fields:

- In analytic geometry, we recall that an analytic variety is the zero set of an analytic map from \mathbb{C}^n to \mathbb{C}^m . We define an *analytic stratified space* as a space whose support is an analytic variety and whose strata are analytic manifolds such that:

$$\forall (X, Y) \in \Sigma^2, \quad \text{if } X \leq Y \text{ then } \dim(X) \leq \dim(Y).$$

Such a definition is equivalent to the one of H. Whitney [36] in the context of analytic geometry.

- In differential geometry, following the works of J. Mather [21] and R. Thom [33], C. Murolo and D. Trotman [25] define stratifications as stratified spaces whose strata are endowed with a connected manifold structure (whose topology is compatible with the one of the support) which satisfy:

$$\forall (X, Y) \in \Sigma^2, \quad \text{if } X < Y \text{ then } \dim(X) < \dim(Y).$$

Such a stratified space is called here a *differentiable stratified space*. This object occurs notably in singularity theory or in the study of a smooth generic map zero set (see [33], [21]).

1.2.3. Stratifications of laminations. — Similarly, we introduce the concept of (C^r) -*laminar stratified space*: a stratified space (A, Σ) whose strata are endowed with a structure of lamination (compatible with the topology of A) satisfying:

$$\forall (X, Y) \in \Sigma^2, \quad \text{if } X \leq Y \text{ then } \dim(X) \leq \dim(Y).$$

As an analytic or differentiable stratified space defines a canonical structure of a laminar space, we will abuse of language by using *stratified space* to refer to a *laminar stratified space*, in the rest of this work.

In general, differentiable stratified spaces are used with extra regularity conditions: either by supposing them embedded, with a certain regularity, into a manifold, or by endowing them with a supplementary geometric structure.

Let us begin by defining the embedding which allows us to introduce some examples of stratified spaces. In section 1.3 we shall introduce a supplementary geometric structure, the trellis of laminations which exist on certain stratified spaces.

An *embedding* i of a stratified space (A, Σ) into a manifold is a homeomorphism onto its image, whose restriction to each stratum is an embedding of laminations.

The embedding i is *a-regular* if for all strata $(X, Y) \in \Sigma^2$ such that $X \leq Y$, and for any sequence $(x_n)_n \in Y^{\mathbb{N}}$ which converges to a point $x \in X$ and such that

the sequence of subspaces $(Ti(T_{x_n}Y))_n$ converges to a subspace E , then $Ti(T_xX)$ is included in E .

When a stratified space is embedded, we often identify the stratified space with its image by the embedding. If the embedding is a -regular, we will say that (in this identification) the *stratification (of laminations) is a -regular*.

The a -regularity condition is due to H. Whitney who showed that every analytic variety supports an a -regular (analytic) stratification [37]. This definition is also standard in the study of differentiable stratified spaces.

EXAMPLE 1.2.3. — Given a submanifold with boundary, the connected components of the boundary and the interior of the submanifold endowed with their canonical manifold structure define a (a -regular) (differentiable) stratification.

EXAMPLE 1.2.4. — The set $\{0\} \times \mathbb{R} \cup \mathbb{R} \times \{0\}$ supports a (differentiable) stratification with two strata: a first stratum being $\{0\}$ and the second being $\{0\} \times \mathbb{R}^* \cup \mathbb{R}^* \times \{0\}$. This stratified space is canonically (a -regularly) embedded into \mathbb{R}^2 .

EXAMPLE 1.2.5. — Given a manifold M and a compact subset K with empty interior, the set K endowed with its 0-dimensional lamination structure and the set $M \setminus K$ endowed with its canonical manifold structure define an a -regular laminar stratification on M .

EXAMPLE 1.2.6. — Let \mathbb{S}^1 be the unit circle and let \mathbb{D} be the unit open disk of the complex plane \mathbb{C} . Let A be the topological subspace $\text{cl}(\mathbb{D}) \times \{1\} \cup \{1\} \times \mathbb{S}^1$ of \mathbb{C}^2 . We stratify A by four strata: the first is the 2-dimensional lamination supported by $\mathbb{D} \times \{1\}$, the others are 0-dimensional and supported by respectively $\mathbb{S}^1 \times \{1\} \setminus \{(1, 1)\}$, $\{1\} \times \mathbb{S}^1 \setminus \{(1, 1)\}$ and $\{(1, 1)\}$. This stratified space is canonically (a -regularly) embedded in \mathbb{C}^2 .

PROPOSITION 1.2.7. — *Let f be a diffeomorphism that satisfies axiom A and the strong transversality condition⁽³⁾. Let $(\Lambda_i)_i$ be the spectral decomposition of the nonwandering set Ω . Let $W^s(\Lambda_i)$ be the union of the stable manifolds of Λ_i 's points. Then the family $(W^s(\Lambda_i))_i$ defines a stratification of laminations on M , where the leaves of $W^s(\Lambda_i)$ are stable manifolds.*

Proof. — We recall that each basic piece Λ_i is a hyperbolic compact subset disjoint from the other basic pieces. As the periodic points are dense in the nonwandering set, there exists a local product structure on Λ_i . It follows from proposition 9.1 of [31] that:

$$W^s(\Lambda_i) := \bigcup_{x \in \Lambda_i} W^s(x) = \{x \in M : d(f^n(x), \Lambda_i) \rightarrow 0, n \rightarrow \infty\}.$$

As the subset $L(f)$ of the accumulation points of orbits is included in the nonwandering set, it follows from lemma 2.2 of [31] that the manifold M is the disjoint union of the subsets $(W^s(\Lambda_i))_i$.

3. See section 2.4.6 for the definition.

Let us now show the frontier condition:

$$\text{cl}(W^s(\Lambda_i)) \cap W^s(\Lambda_j) \neq \emptyset \implies \text{cl}(W^s(\Lambda_i)) \supset W^s(\Lambda_j).$$

First we recall that if $W^s(\Lambda_k)$ intersects $W^u(\Lambda_\ell)$ by the strong transversality condition and the transitivity of Λ_k , the closure of $W^s(\Lambda_k)$ contains $W^s(\Lambda_\ell)$. We write then $\Lambda_k \prec \Lambda_\ell$. Moreover, the strong transversality condition implies the nocycle condition which states that \prec is an order on $(\Lambda_\ell)_\ell$.

We now suppose that the closure of $W^s(\Lambda_i)$ intersects $W^s(\Lambda_j)$. If i is not equal to j , it follows from lemmas 1 and 2, p.10 of [31], that the closure of $W^s(\Lambda_i)$ intersects $W^u(\Lambda_j) \setminus \Lambda_j$. Let x be a point which belongs to this intersection. As $(W^s(\Lambda_k))_k$ covers M , there exists j_1 such that x belongs to $W^s(\Lambda_{j_1})$. By the above reminder, the closure of $W^s(\Lambda_{j_1})$ contains $W^s(\Lambda_j)$. Moreover, the closure of $W^s(\Lambda_i)$ intersects $W^s(\Lambda_{j_1})$. And so on, we can continue to construct $(\Lambda_{j_k})_k$. As the family $(\Lambda_i)_i$ is finite and there are nocycle, the family $(\Lambda_{j_k})_k$ is finite. Thus, we obtain:

$$\text{cl}(W^s(\Lambda_i)) = \text{cl}(W^s(\Lambda_{j_n})) \supset \dots \supset \text{cl}(W^s(\Lambda_{j_1})) \supset W^s(\Lambda_j).$$

This proves the frontier condition.

To finish, it only remains to show the existence of the canonical lamination structure on each $W^s(\Lambda_i)$ (which implies that $W^s(\Lambda_i)$ is locally closed). It follows from the nocycle condition and the fact that $L(f)$ is included in Ω that there exists an adapted filtration to $(\Lambda_i)_i$ (see theorem 2.3 of [31]). In other words, there exists an increasing family of compact subsets $(M_i)_i$ such that:

$$f(M_i) \subset \text{int}(M_i) \quad \text{and} \quad \Lambda_i = \bigcap_{n \in \mathbb{Z}} f^n(M_i \setminus M_{i-1}).$$

Let $U := M_i \setminus M_{i-1}$. As each point $x \in f^{-n}(M_{i-1})$ has its orbit which will belong eventually to M_{i-1} (which does not contain Λ_i), we have:

$$W^s(\Lambda_i) \cap U = W^s(\Lambda_i) \cap M_i \setminus \bigcup_{n \geq 0} f^{-n}(M_{i-1}).$$

Thus, $W^s(\Lambda_i) \cap U$ is f -stable:

$$f(W^s(\Lambda_i) \cap U) \subset W^s(\Lambda_i) \cap U.$$

By replacing $(M_i)_i$ by $(f^n(M_i))_i$, the set $W^s(\Lambda_i) \cap U$ may be an arbitrarily small neighborhood of Λ_i . Hence, for any small ϵ and small U , we may suppose that each point x of $W^s(\Lambda_i) \cap U$ can be ϵ -shadowed by a point y of Λ_i (Λ_i is endowed with a local product structure). It follows that x belongs to the local stable manifold $W_\epsilon^s(y)$ of y . Consequently:

$$W^s(\Lambda_i) \cap U \subset \bigcup_{y \in \Lambda_i} W_\epsilon^s(y).$$

In other words, $W^s(\Lambda_i)$ does not auto-accumulate. Thus, example 1.1.5 shows that $W^s(\Lambda_i)$ is endowed with a lamination structure whose leaves are the stable manifolds of Λ_i 's points. \square

REMARK 1.2.8. — In the above proposition, the strong transversality condition hypothesis cannot be replaced by the nocycle condition. In figure 1, we illustrate the stable manifolds of a Morse flow (given by the vertical gradient). Its time one map is an axiom A map which satisfies the nocycle condition. There are two saddle points whose stable manifolds are one dimensional but their closure intersect each other at a single point.

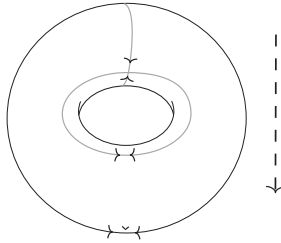

FIGURE 1. Axiom A diffeomorphism without cycle whose stable manifolds do not form a stratification.

REMARK 1.2.9. — In [7], the above proposition was generalized to any axiom A endomorphism which satisfies the strong transversality condition. Its inverse limit of is the union of its unstable manifolds which supports a laminar stratified space structure.

PROPERTY 1.2.10. — Let (A_1, Σ_1) and (A_2, Σ_2) be two stratified spaces. Then the pair $(A_1 \times A_2, \Sigma_1 \times \Sigma_2)$, with:

$$\Sigma_1 \times \Sigma_2 = \{X_1 \times X_2 ; X_1 \in \Sigma_1 \text{ and } X_2 \in \Sigma_2\},$$

is a stratified space of support $A_1 \times A_2$. Moreover, if p_1 and p_2 are embeddings of (A_1, Σ_1) and (A_2, Σ_2) into manifolds M_1 and M_2 respectively, the map $p := (p_1, p_2)$ is an embedding of $(A_1 \times A_2, \Sigma_1 \times \Sigma_2)$ into $M_1 \times M_2$. This embedding is a -regular if and only if p_1 and p_2 are a -regular.

Proof. — To check that $\Sigma_1 \times \Sigma_2$ defines a stratified space is elementary: for all $(X_1 \times X_2, Y_1 \times Y_2) \in (\Sigma_1 \times \Sigma_2)^2$, we have

$$X_1 \times X_2 \cap \text{cl}(Y_1 \times Y_2) \neq \emptyset \iff X_1 \cap \text{cl}(Y_1) \neq \emptyset \text{ and } X_2 \cap \text{cl}(Y_2) \neq \emptyset.$$

Then, for each $i \in \{1, 2\}$, we have $X_i \subset \text{cl}(Y_i)$ and $\dim(X_i) \leq \dim(Y_i)$. This implies that $X_1 \times X_2 \subset \text{cl}(Y_1 \times Y_2)$ and $\dim(X_1 \times X_2) \leq \dim(Y_1 \times Y_2)$.

The proof of the statement on a -regularity is left to reader. \square

Let (A, Σ) be a stratified space and U an open subset of A . The set $\Sigma|U$ of the restrictions of strata $X \in \Sigma$ that intersect U , to $U \cap X$, defines a stratification of laminations on U .

1.2.4. Stratified morphisms. — Let (A, Σ) and (A', Σ') be two C^r -stratified spaces.

A continuous map f from A to A' is a (C^r) -stratified morphism (resp. stratified immersion) if each stratum $X \in \Sigma$ is sent into a stratum $X' \in \Sigma'$ and the restriction $f|_X$ is a C^r -morphism (resp. immersion) from the lamination X to X' . We will also say that f is a (C^r) -morphism (resp. immersion) from (A, Σ) to (A', Σ') .

In the particular case of differentiable stratified spaces, we are consistent with the usual definition of stratified morphisms.

A stratified endomorphism (A, Σ) is a stratified morphism which preserves each stratum.

We denote respectively by $\text{Mor}^r(\Sigma, \Sigma')$, $\text{Im}^r(\Sigma, \Sigma')$ and $\text{End}^r(\Sigma)$ the set of C^r -stratified morphisms, immersions and endomorphisms.

Two stratified morphisms f and \hat{f} are equivalent if they send each stratum $X \in \Sigma$ into a same stratum $X' \in \Sigma'$ and if their restrictions to X are equivalent as laminar morphisms from X to X' . We denote by $\text{Mor}_f^r(\Sigma, \Sigma')$ the equivalence class of f endowed with the topology induced by the following product:

$$C^0(A, A') \times \prod_{\substack{X \in \Sigma \\ f(X) \subset X' \in \Sigma'}} \text{Mor}_{f|_X}^r(X, X').$$

The aim of this work is to show the persistence of some a -regular normally expanded stratifications. However, the regularity of these stratifications is not sufficient to guarantee their persistence: there exist compact differentiable stratifications which are normally expanded but not persistent (we will give such an example in section 2.3). We are going to introduce a stronger regularity condition: to support a trellis structure. For differentiable stratified spaces, other authors have introduced other intrinsic conditions (see [21], [33], [25]).

1.3. Structures of trellis of laminations

Throughout this section, unless stated otherwise, all laminations, laminar stratified spaces and morphisms are supposed to be of class C^r , for $r \geq 1$ fixed.

We need some preliminary definitions:

DEFINITION 1.3.1 (coherence and compatibility of two laminations)

Let L_1 and L_2 be two subsets of a metric space L , endowed with lamination structures denoted by \mathcal{L}_1 and \mathcal{L}_2 respectively. Let us suppose that, for example, the dimension of \mathcal{L}_2 is at least equal to the dimension of \mathcal{L}_1 .

The laminations \mathcal{L}_1 and \mathcal{L}_2 are coherent if, for all $x \in L_1 \cap L_2$, there exists a plaque of \mathcal{L}_1 containing x and included in a plaque of \mathcal{L}_2 .

The laminations \mathcal{L}_1 and \mathcal{L}_2 are compatible if, for all $x \in L_1 \cap L_2$, the leaf of \mathcal{L}_1 containing x is included in a leaf of \mathcal{L}_2 .

EXAMPLE 1.3.2. — Let $\mathcal{L}_1 := \mathbb{R} \times \{0\}$, $\mathcal{L}_2 := (-1, 1)^2$ and $\mathcal{L}_3 := \mathbb{R} \times (-1, 1)$ be three laminations embedded in \mathbb{R}^2 , each of them formed by a single leaf. The laminations

\mathcal{L}_1 and \mathcal{L}_3 are compatible (and so coherent) whereas the laminations \mathcal{L}_1 and \mathcal{L}_2 are coherent but not compatible.

DEFINITION 1.3.3 (foliated lamination). — Let (L_1, \mathcal{L}_1) and (L_2, \mathcal{L}_2) be two laminations of dimension $d_1 \leq d_2$ respectively. We will say that \mathcal{L}_1 is a *foliation* of \mathcal{L}_2 if $L_1 = L_2$ and if, for every $x \in L_2$, there exists a neighborhood U of x and a chart (U, ϕ) which belongs to \mathcal{L}_1 and to \mathcal{L}_2 . This means that there exists open subsets U_1 and U_2 of \mathbb{R}^{d_1} and $\mathbb{R}^{d_2-d_1}$ respectively, such that:

$$\left(\phi : U \rightarrow U_1 \times \underbrace{U_2 \times \widehat{T_2}}_{\text{transversal space of } \mathcal{L}_1} \right) \in \mathcal{L}_1 \cap \mathcal{L}_2.$$

transversal space of \mathcal{L}_2

We note that the laminations \mathcal{L}_1 and \mathcal{L}_2 are then coherent.

REMARK 1.3.4. — In this definition, if the lamination \mathcal{L}_2 is a manifold, then \mathcal{L}_1 is a (classical) C^r -foliation of dimension d_1 on this manifold.

REMARK 1.3.5. — Unlike laminations, a C^1 -foliation is not diffeomorphic to a C^∞ -foliation. For instance, the suspension of a Denjoy C^1 -diffeomorphism defines a C^1 -foliation which is not diffeomorphic to a C^2 -foliation.

EXAMPLE 1.3.6. — Let K be a locally compact set and let $L_1 = L_2$ be the product $\mathbb{R}^{d_2} \times K$. Let \mathcal{L}_2 be the canonical lamination structure of dimension d_2 on L_2 . Let d_1 be an integer less than d_2 , let ϕ be a continuous map from K to $\text{Diff}^r(\mathbb{R}^{d_2}, \mathbb{R}^{d_2})$ and let \mathcal{L}_1 be the lamination structure on L_1 whose leaves are:

$$\{ \phi(k)(\mathbb{R}^{d_1} \times \{t\}) \times \{k\}, (k, t) \in K \times \mathbb{R}^{d_2-d_1} \}.$$

Then \mathcal{L}_1 is a C^r -foliation of \mathcal{L}_2 .

PROPERTY 1.3.7. — Let (L, \mathcal{L}) be a lamination immersed into a manifold M . We identify (L, \mathcal{L}) with its image in M . Let \mathcal{F} be a C^r -foliation on an open neighborhood of L , whose leaves are transverse to the leaves of \mathcal{L} . Then the connected, transverse intersections of plaques of \mathcal{L} with plaques of \mathcal{F} form the plaques of a lamination $\mathcal{L} \pitchfork \mathcal{F}$ on L which is a C^r -foliation of \mathcal{L} .

Proof. — As the statement is a locale property, it is sufficient to prove it in a neighborhood of every point $x \in L$. Via a local chart of \mathcal{F} , we identify a neighborhood U of x to \mathbb{R}^n and \mathcal{F} to the foliation associated to the splitting $\mathbb{R}^{n-d} \times \mathbb{R}^d$, whose leaves are of dimension d . We can suppose that, in this identification, $T_x \mathcal{L}$ is the vectorial subspace $\mathbb{R}^{d'} \times \{0\}$ of \mathbb{R}^n , with $d' \geq n - d$.

We can suppose U small enough such that the intersection of the leaves of \mathcal{L} with U can be identified to a continuous family of C^r -graphs from $\mathbb{R}^{d'}$ to $\mathbb{R}^{n-d'}$. Let $(\rho_t)_{t \in T}$ be such a family of C^r -maps. We note that the following application is a chart of \mathcal{L} :

$$\phi_0 : \mathbb{R}^n \cap L \longrightarrow \mathbb{R}^d \times T, \quad (u, \rho_t(u)) \longmapsto (u, t).$$

Thus, for all $t \in T$ and $v \in \mathbb{R}^{n-d}$, the intersection of the plaque of \mathcal{L} :

$$\{ (u_1, u_2, \rho_t(u_1, u_2)) : (u_1, u_2) \in \mathbb{R}^{n-d} \times \mathbb{R}^{d'+d'-n} \}$$

with the plaque $\{v\} \times \mathbb{R}^{d+d'-n} \times \mathbb{R}^{n-d'}$ of \mathcal{F} , is:

$$\{(v, u_2, \rho_t(v, u_2)) : u_2 \in \mathbb{R}^{d+d'-n}\}.$$

The chart ϕ_0 sends this intersection onto $\{v\} \times \mathbb{R}^{d+d'-n} \times \{t\}$. Let

$$\psi(v, u) \in \mathbb{R}^{n-d'} \times \mathbb{R}^{d+d'-n} \mapsto (u, v) \in \mathbb{R}^{d+d'-n} \times \mathbb{R}^{n-d'}.$$

Finally, we define

$$\phi : \mathbb{R}^n \cap L \longrightarrow \mathbb{R}^{d'+d-n} \times \mathbb{R}^{n-d} \times T, \quad (u, \rho_t(u)) \longmapsto (\psi(u), t)$$

which is a chart of \mathcal{L} and of $\mathcal{L} \pitchfork \mathcal{F}$. We conclude that the lamination $\mathcal{L} \pitchfork \mathcal{F}$ is a foliation of the lamination \mathcal{L} . \square

DEFINITION 1.3.8 (tubular neighborhood). — Let (A, Σ) be a stratified space and let X be a stratum of Σ . A *tubular neighborhood* of X is a lamination (L_X, \mathcal{L}_X) such that:

- the support L_X is a neighborhood of X included in the union of strata incident to X ;
- the leaves of the stratum X are leaves of \mathcal{L}_X ;
- the lamination (L_X, \mathcal{L}_X) is coherent with the other strata of Σ .

DEFINITION 1.3.9 (trellis structure). — A (C^r) -*trellis (of laminations) structure* on a stratified space (A, Σ) is a family of tubular neighborhoods $\mathcal{T} = (L_X, \mathcal{L}_X)_{X \in \Sigma}$ satisfying, for all $X \leq Y$, that the lamination $\mathcal{L}_X|_{L_X \cap L_Y}$ is a C^r -foliation of the lamination $\mathcal{L}_Y|_{L_X \cap L_Y}$.

Throughout the rest of this chapter, all the trellis structures are supposed to be of class C^r . We will not mention their regularity.

REMARK 1.3.10. — If (A, Σ) is a single lamination (L, \mathcal{L}) , then (L, \mathcal{L}) is also the unique trellis structure on the stratified space (A, Σ) .

EXAMPLE 1.3.11. — Let (X_0, X_1, X_2) be the canonical stratification on the filled square: the lamination X_0 is the subset of vertices, the lamination X_1 is one-dimensional and supported by the edges and finally the lamination X_2 is two-dimensional and supported by the interior.

Let \mathcal{L}_{X_0} be the 0-dimensional lamination structure on a neighborhood of the vertices. Let \mathcal{L}_{X_1} be the 1-dimensional lamination structure on four disjoint neighborhoods of each edge, whose leaves are parallel to the associated edge. Then the family $((L_{X_0}, \mathcal{L}_{X_0}), (L_1, \mathcal{L}_1), X_2)$ forms a trellis structure on (A, Σ) . We illustrate this structure in figure 2.

EXAMPLE 1.3.12. — Let I be an open interval of \mathbb{R} . We denote ∂I its boundary. Let C be the closed and filled cylinder in \mathbb{R}^3 defined by

$$C := \{(x, y, z) \in \mathbb{R}^3; x^2 + y^2 \leq 1 \text{ and } z \in \text{cl}(I)\}.$$

The cylinder C supports the stratification of laminations consisting of the following strata:

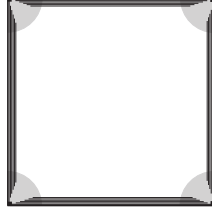

FIGURE 2. A trellis structure on the filled square

- the 0-dimensional lamination X_0 supported by $\mathbb{S}^1 \times \partial I$;
- the 1-dimensional lamination X_1 supported by $\mathbb{S}^1 \times I$ whose leaves are vertical;
- the 2-dimensional lamination X_2 supported by $\mathbb{D} \times \partial I$;
- the 3-dimensional lamination X_3 supported by the interior of C .

This stratification is canonically a -regularly embedded into \mathbb{R}^3 .

Let us construct a trellis structure on this stratified space. Let L_{X_0} be an open neighborhood of X_0 in C . We endow L_{X_0} with the 0-dimensional lamination structure \mathcal{L}_{X_0} . Let L_{X_1} and L_{X_2} be two disjoint open subsets of $C \setminus X_0$ containing respectively X_1 and X_2 . We endow L_{X_1} with the 1-dimensional lamination structure \mathcal{L}_{X_1} whose leaves are vertical. We endow L_{X_2} with the 2-dimensional lamination structure \mathcal{L}_{X_2} whose leaves are horizontal. Finally, we define $(L_{X_3}, \mathcal{L}_{X_3})$ as equal to the lamination X_3 . We notice that $\mathcal{T} := (L_{X_i}, \mathcal{L}_{X_i})_{i=0}^3$ is a trellis structure on the stratified space (C, Σ) .

The figure 2 also illustrates a section of such a trellis structure by a plane containing the axis (O_z) .

EXAMPLE 1.3.13. — With conventions of figure 2, figure 3 gives a trellis structure on the canonical stratification of a cube, that is, the simplicial splitting into vertex, edges and faces.

Let \mathcal{T} be a trellis structure on a stratified space (A, Σ) and let U be an open subset of A . Then the family of restrictions of the laminations $(L, \mathcal{L}) \in \mathcal{T}$ to U forms a trellis structure on $(U, \Sigma|U)$. We denote by $\mathcal{T}|U$ this trellis structure.

REMARK 1.3.14. — Given a trellis structure on a stratified space (A, Σ) , the foliation condition implies the coherence between the tubular neighborhoods.

The following property implies in particular that every tubular neighborhood is compatible with every stratum.

PROPERTY 1.3.15. — *Let (A, Σ) be a stratified space and let (L, \mathcal{L}) be a lamination such that L is included in the union of strata of dimension at least equal to the dimension of \mathcal{L} . If the lamination \mathcal{L} is coherent with each stratum of Σ , then for each stratum $X \in \Sigma$, the set $X \cap L$ is \mathcal{L} -admissible.*

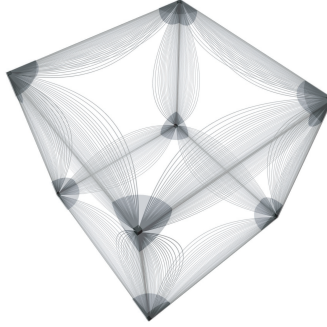

FIGURE 3. A trellis structure on a cube.

Proof. — The coherence implies that the leaves of \mathcal{L} intersect the leaves of each stratum of Σ in an open set. This is why the partition Σ of A induces a partition of each leaves into open sets. By connectedness, each leaf is contained in a unique leaf of a stratum of Σ . This implies that the subset $X \cap L$ is \mathcal{L} -saturated for every stratum $X \in \Sigma$. As the intersection of two locally compact subsets is locally compact, the subset $X \cap L$ is \mathcal{L} -admissible. \square

PROPERTY 1.3.16. — *Let (A, Σ) be a stratified space which admits a trellis structure. Then A is locally compact.*

Proof. — The family of the supports of the tubular neighborhoods is an open covering of A . As each of these supports is locally compact, it follows that A is locally compact. \square

Let M be a manifold and let (A, Σ) be a stratified space endowed with a C^r -trellis structure \mathcal{T} . A stratified embedding i from (A, Σ) into M is (C^r) - \mathcal{T} -controlled if the restriction of i to each tubular neighborhood (L_X, \mathcal{L}_X) of \mathcal{T} is a C^r -embedding of the lamination \mathcal{L}_X into M . In other words, a \mathcal{T} -controlled C^r -embedding of (A, Σ) in M is a homeomorphism onto its image such that the r -first partial derivatives of p along the leaves of each tubular neighborhood (L_X, \mathcal{L}_X) exist, are continuous on L_X and the first one is injective.

Figure 4 represents a \mathcal{T} -controlled embedding into \mathbb{R}^3 of the stratified space defined in example 1.3.12 (not equal to the canonical inclusion).

A controlled embedding into the space \mathbb{R}^3 of the cube, endowed with its trellis structure defined in figure 3 is represented in figure 5.

PROPERTY 1.3.17. — *Let M be a manifold and let (A, Σ) be a stratified space endowed with a trellis structure \mathcal{T} . Then any \mathcal{T} -controlled embedding is a -regular.*

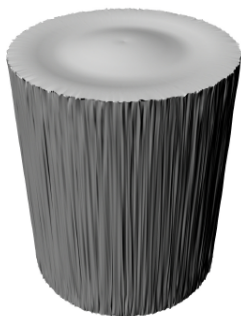

FIGURE 4. Controlled embedding of an exotic stratification on the cylinder.

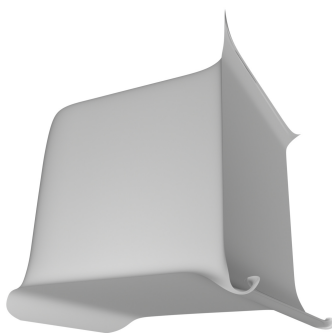

FIGURE 5. Controlled embedding of a cube.

Proof. — Let $X \leq Y$ be two strata of Σ . Let $(x_n)_n \in Y^{\mathbb{N}}$ be a sequence which converges to $x \in X$. Then, for n large enough, the point x_n belongs to L_X and $Ti(T_{x_n}Y)$ contains $Ti(T_{x_n}L_X)$ which converges to $Ti(T_xX)$. \square

We will remark in sections 1.3.2 and 2.3, that there exist stratified spaces which cannot support any trellis structure. However, the following proposition gives sufficient conditions for a stratified space to admit a trellis structure.

PROPOSITION 1.3.18. — *Let (A, Σ) and (A', Σ') be two stratified spaces. If each of these stratified spaces admits a trellis structure, then there exists a trellis structure on the product stratified space $(A \times A', \Sigma \times \Sigma')$.*

Proof. — We have already seen in property 1.2.10 that $(A \times A', \Sigma \times \Sigma')$ is a stratified space whose partial order \leq on $\Sigma \times \Sigma'$ satisfies

$$\forall X \times X', Y \times Y' \in \Sigma \times \Sigma', \quad (X \times X' \leq Y \times Y') \Leftrightarrow (X \leq Y \text{ and } X' \leq Y').$$

We now apply the following lemma for the stratified space $(A \times A', \Sigma \times \Sigma)$ equipped with this partial order.

LEMMA 1.3.19. — *For every stratified space (A, Σ) , there exists a family of open subsets $(W_X)_{X \in \Sigma}$ such that W_X is a neighborhood of X and intersects W_Y if and only if X and Y are incident.*

Proof. — Let X be a stratum of Σ and let χ be the subset of Σ consisting of strata which are not comparable to X . We note that

$$X \cap \text{cl} \left(\bigcup_{Y \in \chi} Y \right) = X \cap \left(\bigcup_{Y \in \chi} \text{cl}(Y) \right) = \bigcup_{Y \in \chi} (X \cap \text{cl}(Y)) = \emptyset.$$

Consequently, for any point $x \in X$, the distance between x and $\bigcup_{Y \in \chi} Y$ is positive. We define

$$W_X := \bigcup_{x \in X} B(x, \frac{1}{2}d(x, \bigcup_{Y \in \chi} Y)).$$

We remark that the open set W_X is a neighborhood of X .

Let Y be a stratum of χ ; we denote by Υ the subset of Σ which is not comparable to Y . Let $x \in X$ and $y \in Y$; we have then $x \in \bigcup_{Z \in \Upsilon} Z$ and $y \in \bigcup_{Z \in \Upsilon} Z$; this implies

$$B(x, \frac{1}{2}d(x, \bigcup_{Z \in \Upsilon} Z)) \cap B(y, \frac{1}{2}d(y, \bigcup_{Z \in \Upsilon} Z)) = \emptyset.$$

Consequently W_X and W_Y are disjoint. \square

By using this lemma with the product stratification $\Sigma \times \Sigma'$, we can define an open family $(W_{X \times X'})_{(X, X') \in \Sigma \times \Sigma'}$ satisfying $W_{X \times X'} \supset X \times X'$ and

$$W_{X \times X'} \cap W_{Y \times Y'} \neq \emptyset \implies X \times X' \leq Y \times Y' \text{ or } X \times X' \geq Y \times Y'.$$

We denote by $(L_X, \mathcal{L}_X)_{X \in \Sigma}$ and $(L_{X'}, \mathcal{L}_{X'})_{X' \in \Sigma'}$ the trellis structures on the stratified spaces (A, Σ) and (A', Σ') .

Let $L_{X \times X'}$ be the open neighborhood $(L_X \times L_{X'}) \cap W_{X \times X'}$ of $X \times X'$, that we endow with the laminar structure $\mathcal{L}_{X \times X'} := (\mathcal{L}_X \times \mathcal{L}_{X'})|_{L_{X \times X'}}$.

As X and X' are restrictions of respectively (L_X, \mathcal{L}_X) and $(L_{X'}, \mathcal{L}_{X'})$ to admissible subsets, the stratum $X \times X'$ is the restriction of $\mathcal{L}_{X \times X'}$ to an admissible subset.

Moreover, if $L_{X \times X'}$ and $L_{Y \times Y'}$ have a non-empty intersection, then $W_{X \times X'}$ and $W_{Y \times Y'}$ have also a non-empty intersection. Therefore, $X \times X'$ and $Y \times Y'$ are comparable. We suppose for instance that $X \times X' \leq Y \times Y'$. This is equivalent to suppose that $X \leq Y$ and $X' \leq Y'$. The lamination

$$(L_X \cap L_Y, \mathcal{L}_X|_{L_X \cap L_Y})$$

is a C^r -foliation of the lamination $(L_X \cap L_Y, \mathcal{L}_Y|_{L_X \cap L_Y})$ and

$$(L_{X'} \cap L_{Y'}, \mathcal{L}_{X'}|_{L_{X'} \cap L_{Y'}})$$

is a C^r -foliation of the lamination $(L_{X'} \cap L_{Y'}, \mathcal{L}_{Y'}|_{L_{X'} \cap L_{Y'}})$. As the product of C^r -foliated laminations is a C^r -foliated lamination, the restriction

$$(L_{X \times X'} \cap L_{Y \times Y'}, \mathcal{L}_{X \times X'}|_{L_{X \times X'} \cap L_{Y \times Y'}})$$

is a foliation of the lamination of $(L_{X \times X'} \cap L_{Y \times Y'}, \mathcal{L}_{Y \times Y'}|_{L_{X \times X'} \cap L_{Y \times Y'}})$.

Therefore $\mathcal{T}_{\text{prod}} := (L_{X \times X'}, \mathcal{L}_{X \times X'})_{X \times X' \in \Sigma \times \Sigma'}$ is a trellis structure on the product stratified space. \square

1.3.0.1. Structure of the union of strata of the same dimension. — The following property sheds light on the geometry of the union of strata of the same dimension.

PROPERTY 1.3.20. — *Let (A, Σ) be a stratified space endowed with a trellis structure \mathcal{T} . Let $(d_p)_{p \geq 0}$ be the strictly increasing sequence of the different dimensions of strata of Σ . Then, it holds for each $p \geq 0$:*

- 1) *The union of strata of dimension d_p constitutes a lamination X_p . Every stratum of dimension d_p is the restriction of X_p to an admissible subset.*
- 2) *The union of tubular neighborhoods of strata of dimension d_p forms a lamination (L_p, \mathcal{L}_p) .*
- 3) *X_p is the restriction of \mathcal{L}_p to an admissible subset.*
- 4) *For all $q \leq p$, the subset $\text{cl}(X_p) \cap X_q$ is an X_q -admissible subset.*
- 5) *The subset $\text{cl}(X_p)$ is included in $\bigcup_{q \leq p} X_q$.*

Proof. — 2) Let $\Sigma_p \subset \Sigma$ be the subset of the d_p -dimensional strata. For all strata $X, Y \in \Sigma_p$, the lamination $\mathcal{L}_X|_{L_X \cap L_Y}$ is a C^r -foliation of $\mathcal{L}_Y|_{L_X \cap L_Y}$ of codimension 0. Then the restrictions of the laminations \mathcal{L}_X and \mathcal{L}_Y to $L_X \cap L_Y$ are generated by a same atlas and so are equal. It follows from property 1.1.3 that the set of the charts of \mathcal{L}_X for all $X \in \Sigma_p$ generates a lamination structure \mathcal{L}_p on $L_p := \bigcup_{X \in \Sigma_p} L_X$.

1)–3) First of all, by local finiteness of Σ , the set X_p is locally compact. Moreover, all the tubular neighborhoods of strata that belong to Σ_p are coherent with the strata of Σ and their union constitutes an open covering of L_p . So, the lamination \mathcal{L}_p is coherent with Σ . Property 1.3.15 implies that for $X \in \Sigma_p$ the support of $X = X \cap L_p$ is \mathcal{L}_p -admissible. Thus, a leaf of \mathcal{L}_p which intersects X is contained in X , and so equal to a leaf of X . Since L_p contains X_p , X_p is canonically endowed with the lamination structure $\mathcal{L}_p|_{X_p}$ and 1)–3) are satisfied.

4) The frontier condition implies that

$$\text{cl}(X_p) \cap X_q = \bigcup_{\substack{X \in \Sigma_p \\ Y \in \Sigma_q}} \text{cl}(X) \cap Y = \bigcup_{\substack{X \in \Sigma_p \\ Y \in \Sigma_q \\ Y \leq X}} Y.$$

As each stratum of Σ_q is X_q -admissible and as the stratification is locally finite, $\text{cl}(X_p) \cap X_q$ is X_q -admissible.

5) The frontier condition implies that

$$\text{cl}(X_p) = \bigcup_{X \in \Sigma_p} \text{cl}(X) = \bigcup_{X \in \Sigma_p} \bigcup_{Y \leq X} Y \subset \bigcup_{q \leq p} \bigcup_{X \in \Sigma_q} X = \bigcup_{q \leq p} X_k. \quad \square$$

REMARK 1.3.21. — In example 1.2.6, the pair $(A, (X_p)_p)$ is not a stratified space. ⁽⁴⁾

QUESTION 1.3.22. — *Given a compact subset C of \mathbb{R}^n which is the union of two disjoint locally compact subsets A and B , does there exist an (abstract) stratification on C such that A and B are unions of strata?*

1.3.0.2. *Morphisms $(\mathcal{T}_A, \mathcal{T}_{A'})$ -controlled.* — Let (A, Σ) and (A', Σ') be two stratified spaces admitting a trellis structure \mathcal{T} and \mathcal{T}' respectively.

A (C^r) -*morphism* (resp. *immersion*) $(\mathcal{T}, \mathcal{T}')$ -*controlled* is a stratified morphism f from (A, Σ) to (A', Σ') such that, for every stratum $X \in \Sigma$, there exists a neighborhood V_X of X in L_X such that the restriction of f to V_X is a morphism (resp. immersion) from the lamination $\mathcal{L}_X|V_X$ into the lamination $\mathcal{L}_{X'}$, where X' is the stratum of Σ' which contains the image by f of X . In other words, every plaque of \mathcal{L}_X contained in V_X is sent into a leaf of $\mathcal{L}_{X'}$, the r -first derivatives of f along such a plaque exist, are continuous on V_X (resp. and the first one is moreover injective) and f is continuous.

The neighborhood V_X of X is *adapted* to f , and the family of neighborhoods $\mathcal{V} := (V_X)_{X \in \Sigma}$ is *adapted* to f (and to $(\mathcal{T}, \mathcal{T}')$).

If (A', Σ') is a manifold M , then M is also the only trellis structure on the stratified space M . In this case, we will say that this C^r -morphism is \mathcal{T} -*controlled*.

The \mathcal{T} -*controlled embeddings* from (A, Σ) to M are the \mathcal{T} -controlled are immersions which are homeomorphisms onto their images.

A \mathcal{T} -*controlled endomorphism* is a stratified endomorphism f of (A, Σ) which is $(\mathcal{T}, \mathcal{T})$ -controlled. This means that each stratum X is sent by f into itself and that there exists a neighborhood V_X of X in L_X such that the restriction $f|V_X$ is a morphism from the lamination $\mathcal{L}_X|V_X$ to \mathcal{L}_X .

We denote by $\text{Mor}^r(\mathcal{T}, \mathcal{T}')$, $\text{Im}^r(\mathcal{T}, \mathcal{T}')$ and $\text{Emb}^r(\mathcal{T}, \mathcal{T}')$ the sets of $(\mathcal{T}, \mathcal{T}')$ -controlled C^r -morphisms, immersions and embeddings respectively. We denote by $\text{End}^r(\mathcal{T})$ the set of \mathcal{T} -controlled C^r -endomorphisms.

Throughout the rest of this chapter, all controlled morphisms are supposed to be of class C^r .

PROPERTY 1.3.23. — *Let (A, Σ) , (A', Σ') , and (A'', Σ'') be stratified spaces admitting a trellis structure \mathcal{T} , \mathcal{T}' and \mathcal{T}'' respectively.*

— *The identity of A is a \mathcal{T} -controlled endomorphism.*

4. However, if the frontier condition is replaced by the following more general condition:

“for every pair of strata (X, Y) such that $\text{cl}(X)$ intersects Y , the subset $\text{cl}(X) \cap Y$ is Y -admissible and $\dim Y$ is at least equal to $\dim X$ ”,

it appears that all that is proved in this work remains true and that $(A, (X_p)_p)$ is still a stratified space. Moreover $(L_p, \mathcal{L}_p)_p$ is also a trellis structure on $(A, (X_p)_p)$.

— The composition of a $(\mathcal{T}', \mathcal{T}'')$ -controlled morphism with a $(\mathcal{T}, \mathcal{T}')$ -controlled morphism is a $(\mathcal{T}, \mathcal{T}'')$ -controlled morphism.

Proof. — The identity of A is clearly a controlled endomorphism. Let us prove that the composition of two controlled morphisms is a controlled morphism.

Let $f \in \text{Mor}^r(\mathcal{T}, \mathcal{T}')$ and $f' \in \text{Mor}^r(\mathcal{T}', \mathcal{T}'')$. Each stratum $X \in \Sigma$ is sent by f into a stratum $X' \in \Sigma'$ which is sent by f' into a stratum X'' . Let V_X and $V_{X'}$ be two neighborhoods of X and X' adapted to respectively f and f' . Then the neighborhood $V_X \cap f^{-1}(V_{X'})$ of X is adapted to $f' \circ f$. \square

1.3.1. Equivalent controlled morphisms. — Let \mathcal{T} and \mathcal{T}' be two trellis structures on the stratified spaces (A, Σ) and (A', Σ') respectively. Two morphisms f and \widehat{f} of $\text{Mor}^r(\mathcal{T}, \mathcal{T}')$ (resp. $\text{Im}^r(\mathcal{T}, \mathcal{T}')$, resp. $\text{End}^r(\mathcal{T}')$) are *equivalent* if, for each stratum $X \in \Sigma$, there exists a stratum $X' \in \Sigma'$ such that f and \widehat{f} send X into an X' and there exists a neighborhood V_X of X in L_X such that the restrictions $f|_{V_X}$ and $\widehat{f}|_{V_X}$ are equivalent morphisms of laminations from $\mathcal{L}_X|_{V_X}$ to $\mathcal{L}_{X'}$. This means that every point $x \in V_X$ has a plaque sent by f and \widehat{f} into a same leaf of $\mathcal{L}_{X'}$.

Given a family of tubular neighborhoods $\mathcal{V} = (V_X)_X$ adapted to f , we denote by $\text{Mor}_{f\mathcal{V}}^r(\mathcal{T}, \mathcal{T}')$ (resp. $\text{Im}_{f\mathcal{V}}^r(\mathcal{T}, \mathcal{T}')$, resp. $\text{End}_{f\mathcal{V}}^r(\mathcal{T}')$) the set of \mathcal{T} -controlled morphisms \widehat{f} such that \mathcal{V} is also adapted to \widehat{f} and such that, for every $X \in \Sigma$ sent by f into a certain stratum X' , the restrictions of f and \widehat{f} to V_X are equivalent morphisms of laminations from $\mathcal{L}_X|_{V_X}$ to $\mathcal{L}_{X'}$.

We endow $\text{Mor}_{f\mathcal{V}}^r(\mathcal{T}, \mathcal{T}')$ with the topology induced by the product topology of

$$\prod_{\substack{X \in \Sigma \\ f(X) \subset X' \in \Sigma'}} \text{Mor}_{f|_{V_X}}^r(\mathcal{L}_X|_{V_X}, \mathcal{L}'_{X'}).$$

We equip the set of families of neighborhoods adapted to f with the following partial order:

$$\mathcal{V} \leq \mathcal{V}' \iff \forall X \in \Sigma, V_X \subset V'_X.$$

PROPERTY 1.3.24. — Let \mathcal{T} and \mathcal{T}' be two trellis structures on two stratified spaces (A, Σ) and (A', Σ') respectively. Let f be a $(\mathcal{T}, \mathcal{T}')$ -controlled morphism and let $\mathcal{V} \leq \mathcal{V}'$ be two families adapted to f . Then the topology of $\text{Mor}_{f\mathcal{V}'}^r(\mathcal{T}, \mathcal{T}')$ is equal to the topology induced by $\text{Mor}_{f\mathcal{V}}^r(\mathcal{T}, \mathcal{T}')$.

Proof. — By definition of these topologies it is clear that the topology of $\text{Mor}_{f\mathcal{V}'}^r(\mathcal{T}, \mathcal{T}')$ is finer than the topology induced by $\text{Mor}_{f\mathcal{V}}^r(\mathcal{T}, \mathcal{T}')$. So it is sufficient to prove that the topology of $\text{Mor}_{f|_{V'_X}}^r(\mathcal{L}_X|_{V'_X}, \mathcal{L}'_{X'})$ is coarser than the topology induced by $\text{Mor}_{f\mathcal{V}}^r(\mathcal{T}, \mathcal{T}')$, for every $X \in \Sigma$. As a compact subset of V'_X is a finite union of compact subsets in $(V_Y)_{Y \geq X}$, the topology of $\text{Mor}_{f|_{V'_X}}^r(\mathcal{L}_X|_{V'_X}, \mathcal{L}'_{X'})$ is coarser than the topology induced by the product

$$\prod_{\substack{Y \geq X \\ f(Y) \subset Y' \in \Sigma'}} \text{Mor}_{f|_{V_Y}}^r(\mathcal{L}_Y|_{V_Y}, \mathcal{L}'_{Y'})$$

which is also coarser than the topology of $\text{Mor}_{f\mathcal{V}}^r(\mathcal{T}, \mathcal{T}')$. \square

This last property implies that the spaces $(\text{Mor}_{f\mathcal{V}}^r(\mathcal{T}, \mathcal{T}'))_{\mathcal{V}}$ are only different by plaque-preserving conditions. If (A', Σ') is a manifold M , then the trellis structure \mathcal{T}' consists of the single manifold M . Plaque-preserving conditions are then obviously always satisfied. Consequently, the space $\text{Mor}_{f\mathcal{V}}^r(\mathcal{T}, \mathcal{T}')$ depends neither on f nor on \mathcal{V} . That is why we abuse notation by denoting by $\text{Mor}^r(\mathcal{T}, M)$ this topological space.

REMARK 1.3.25. — The topology of $\text{Mor}_{f\mathcal{V}}^r(\mathcal{T}, \mathcal{T}')$ is finer than the topology induced by $\text{Mor}_f^r(\Sigma, \Sigma')$. Actually, the topology induced by the compact-open topology of $C^0(A, A')$ is coarser than the topology of $\text{Mor}_{f\mathcal{V}}^r(\mathcal{T}, \mathcal{T}')$. This is because, on the one hand, \mathcal{V} is an open cover of A and the canonical inclusion of $C^0(A, A')$ in $\prod_{X \in \Sigma} C^0(V_X, A')$ is a homeomorphism onto its image. And on the other, for any stratum $X \in \Sigma$ sent by f into a stratum $X' \in \Sigma'$, the topology of $\text{Mor}_{f|_{V_X}}^r(\mathcal{L}_X|_{V_X}, \mathcal{L}'_{X'})$ is finer than the topology $\text{Mor}_{f|_X}^r(X, X')$.

Usually, the topology of $\text{Mor}_{f\mathcal{V}}^r(\mathcal{T}, \mathcal{T}')$ is strictly finer than the topology induced by $\text{Mor}_{f\mathcal{V}}^r(\Sigma, \Sigma')$. For example, let us consider the unit closed disk $\text{cl}(\mathbb{D})$ of the complex plane \mathbb{C} , which supports the canonical (differentiable) stratification Σ formed by the unit disk \mathbb{D} and the unit circle \mathbb{S}^1 . This stratified space admits the trellis structure \mathcal{T} consisting of the tubular neighborhood \mathbb{D} of \mathbb{D} and the lamination $(L_{\mathbb{S}^1}, \mathcal{L}_{\mathbb{S}^1})$ whose leaves are the circles centered in 0 and of radius $\rho \in]\frac{1}{2}, 1]$. Let (θ, ρ) be the polar coordinates on $\text{cl}(\mathbb{D})$. The set of $(\mathcal{T}, \mathbb{R})$ -controlled functions f on $\text{cl}(\mathbb{D})$ such that $\sup_{x \in L_{\mathbb{S}^1}} \|\partial_{\theta} f(x)\| < 1$ is an open subset of $\text{Mor}^r(\mathcal{T}, \mathbb{R})$. But, in every open subset O of $\text{Mor}^r(\Sigma, \mathbb{R})$, there exists a sequence of functions $(f_n)_n \in (\text{Mor}(\mathcal{T}, \mathbb{R}) \cap O)^{\mathbb{N}}$ such that $\sup_{n \geq 0, x \in L_{\mathbb{S}^1}} \|\partial_{\theta} f_n(x)\| = \infty$.

1.3.2. Geometric structures on stratified spaces. — In this section, we recall other works defining structures similar to trellis. These structures are almost always weaker than the trellis structure, because they were used in a topological context.

The study of such structures come back as far as the work of H. Whitney on the study of the singularities of analytic varieties [36].

CONJECTURE 1.3.26 (H. Whitney, 1965). — *Every analytic variety V of \mathbb{C}^n supports an analytic stratification such that, for every point p of a stratum X , there exists a neighborhood U of $p \in V$, a metric space T and a homeomorphism*

$$\phi : (X \cap U) \times T \longrightarrow U$$

such that, for every $t \in T$, the restriction $\phi|_{X \cap U \times \{t\}}$ is biholomorphic onto its image, the differential on these restrictions are continuous on $(X \cap U) \times T$ and the lamination generated by the chart ϕ^{-1} (and of the same dimension as X) is coherent with all the strata.

In other words, H. Whitney conjectured the existence of a stratification that admits locally a tubular neighborhood, with holomorphic leaves, for each stratum.

Later, R. Thom and J.N. Mather were also interested in these structures for the study of the singularities of differentiable maps. They introduced differentiable stratified spaces (A, Σ) with extra intrinsic regularity conditions which in some cases allow to prove that their stratifications are locally trivial: for every point $x \in A$ which belongs to a stratum $X \in \Sigma$, there exists a neighborhood U of x in A , a neighborhood V of x in X , a differentiable stratified space (A', Σ') and a homeomorphism $h : V \times A' \rightarrow U$ such that the strata of $\Sigma|U$ are the images by h of strata of the product stratified space $(V \times A', X|V \times \Sigma')$.

In 1993, D. Trotman adapted the Whitney's conjecture to differentiable stratified spaces.⁽⁵⁾ To formulate his conjecture, let us recall that an embedding p of a differentiable stratified space (A, Σ) into \mathbb{R}^n is *b-regular* if for all strata $(X, Y) \in \Sigma^2$ with $Y < X$, for all sequences $(x_i)_i \in X^{\mathbb{N}}$ and $(y_i)_i \in Y^{\mathbb{N}}$ which converge to $y \in Y$, if $(T_{x_i} X)_i$ converges to τ and the unitary vector in the direction of $\overline{x_i y_i} \in \mathbb{R}^n$ converges to λ , then λ is included in τ .

It is well known and easy to show that *b-regularity* implies *a-regularity*.

The Trotman's conjecture is the following:

CONJECTURE 1.3.27 (D. Trotman 1993). — *Let (A, Σ) be a differentiable stratified space b-regularly embedded by p into \mathbb{R}^n ; then for every stratum $X \in \Sigma$ and point $x \in X$, there exists a neighborhood U of x and a tubular neighborhood (L, \mathcal{L}) of $X|U \cap X$ in the stratified space $(U, \Sigma|U)$ such that the restriction $p|L$ is an embedding of (L, \mathcal{L}) .*

Unfortunately, we will see in part 2.4.1 that there exist *b-regular* stratifications that are persistent but not *b-regularly* persistent.

In the spirit of this conjecture, in his PhD thesis C. Murolo [25] defines the “système de contrôle feuilleté, totalement compatible et *a-régulier*” which is the data of compatible tubular neighborhoods $(L_X, \mathcal{L}_X)_{X \in \Sigma}$, on a differentiable stratified space.

In another context, for surface diffeomorphisms that satisfy axiom A and the strong transversality condition, W. De Melo [22] built a real trellis structure on the stratification of laminations $(W^s(\Lambda_i))_i$ defined in property 1.2.7.⁽⁶⁾ This construction allowed him to prove the structural persistence of surface C^1 -diffeomorphism that satisfies axiom A and the strong transversality condition. In a local way, this idea was improved by C. Robinson [28] to achieve the proof of the Palis and Smale's conjecture [32]: every C^1 -diffeomorphism of compact manifold that satisfies axiom A and the strong transversality condition is C^1 -structurally stable⁽⁷⁾.

5. This an adaptation because H. Whitney shows that every analytic variety supports a *b-regular* analytic stratification [37].

6. Actually, he requires the existence of a “system of unstable tubular families”. This structure is a family of compatible tubular neighborhoods. Even if the foliation's condition is not required, he proves it. Actually, he is just interested in finding topological properties. The present work can be used to show smoother property of the conjugacy homeomorphism: to be an stratified endomorphism.

7. Actually, he requires the existence of “compatible families of unstable disks”. Even if the algorithm builds, locally, a trellis structure, for the same reason as W. De Melo, he only requires to have locally a “system of unstable tubular families”.

We will see that there exist α -regular stratifications that do not admit trellis structures and are not even locally trivial.

But beyond the local obstructions, there exist also global topological constraints, that prevent stratified spaces to admit trellis structures.

For instance, let us consider the stratification on the tangent bundle of the sphere, consisting of two strata: the first being the image of the zero section endowed with the structure of 2-manifold (that we identify with the sphere \mathbb{S}^2) and the second being the complement of this image, endowed with its structure of 4-manifold. For the sake of contradiction, let us suppose that this stratification admits a trellis structure. Then there exists a lamination on a neighborhood of the sphere in the tangent bundle, such that the sphere is a leaf. As the sphere is simply connected, the holonomy along the leaves is trivial. Therefore we can transport a small non-zero vector of the tangent bundle by holonomy, to define a vector field on the tangent bundle without zero. But it is well known that such a vector field does not exist on the 2-sphere.

CHAPTER 2

PERSISTENCE OF STRATIFICATIONS OF LAMINATIONS

Throughout this chapter, all manifolds considered are of class C^∞ . The regularity classes of laminations, stratifications or trellis structures will be not mentioned if they are not relevant.

In section 2.2.2, we state the main result on persistence of stratifications of normally expanded laminations. In section 2.4, we give various applications of this result. Before dealing with stratifications of laminations, we study the restricted case of laminations (which is a stratification consisting of only one stratum), hoping that the new definitions and the main result will be more understandable.

2.1. Persistence of lamination

2.1.1. Preserved laminations. — A lamination (L, \mathcal{L}) embedded by i into a manifold M is *preserved* by an endomorphism f of M if each embedded leaf of \mathcal{L} is sent by f into an embedded leaf of \mathcal{L} .

This is equivalent to suppose the existence of an endomorphism f^* of (L, \mathcal{L}) such that the following diagram commutes:

$$\begin{array}{ccc} M & \xrightarrow{f} & M \\ i \uparrow & & \uparrow i \\ L & \xrightarrow{f^*} & L \end{array}$$

The endomorphism f^* is the *pullback of f via i* .

When the lamination is only immersed by i , these two definitions are not equivalent.

A lamination (L, \mathcal{L}) immersed by i into a manifold M is *preserved* by an endomorphism f of M if there exists a *pull back of f in (L, \mathcal{L}) via i* . That is an endomorphism f^* of (L, \mathcal{L}) such that the following diagram commutes:

$$\begin{array}{ccc} M & \xrightarrow{f} & M \\ i \uparrow & & \uparrow i \\ L & \xrightarrow{f^*} & L \end{array}$$

The leaves of a lamination (L, \mathcal{L}) immersed by i into a manifold M is *preserved* by an endomorphism f of M if each immersed leaf of \mathcal{L} is sent by f into an immersed leaf of \mathcal{L} .

Clearly, if f preserves an immersed laminations, then it preserves its leaves.

In Appendix D, we give three examples of a diffeomorphism preserving the leaves of an immersed lamination, but not the lamination. In the last example, this happens whatever is the immersion; it is a negative answer to a question of [15].

2.1.2. Persistence of laminations. — Let r be a fixed positive integer. Let (L, \mathcal{L}) be a lamination C^r -embedded by i into a manifold M . Let f be a C^r -endomorphism of M which preserves \mathcal{L} . Let f^* be the pull back of f . Then the embedded lamination (L, \mathcal{L}) is C^r -*persistent* if for any endomorphism f' C^r -close to f , there exists an embedding i' C^r -close to i such that f' preserves the lamination (L, \mathcal{L}) embedded by i' and such that each point $i'(x)$ of $i'(L)$ is sent by f' into the image by i' of a small plaque containing $f^*(x)$. This implies that the pullback f'^* of f' is equivalent and C^r -close to f^* .

Let (L, \mathcal{L}) be a lamination immersed by i into a manifold M . Let f be a C^r -endomorphism of M which preserves \mathcal{L} . Let f^* be a pull back of f in (L, \mathcal{L}) . Then the immersed lamination (L, \mathcal{L}) is C^r -*persistent* if for any endomorphism f' C^r -close to f , there exists an immersion i' C^r -close to i , such that f' preserves the lamination (L, \mathcal{L}) immersed by i' and pullback to (L, \mathcal{L}) to an endomorphism f'^* equivalent and C^r -close to f^* . In other words, for every $f' \in \text{End}^r(M)$ close to f there exists $i' \in \text{Im}^r(\mathcal{L}, M)$ and $f'^* \in \text{End}_{f^*}^r(\mathcal{L})$ close to i and f^* such that the following diagram commutes:

$$\begin{array}{ccc} M & \xrightarrow{f'} & M \\ i' \uparrow & & \uparrow i' \\ L & \xrightarrow{f'^*} & L \end{array}$$

In the above definitions the topology of $\text{End}^r(M)$, $\text{Im}^r(\mathcal{L}, M)$, $\text{Emb}^r(\mathcal{L}, M)$ and $\text{End}_{f^*}^r(\mathcal{L})$ are described in section 1.1.4.

2.1.3. Lamination persistence theorems. — Up to now the following result was the most general theorem showing that hyperbolicity implies persistence of laminations.

THEOREM 2.1.1 (Hirsch-Pugh-Shub [15]). — *Let (L, \mathcal{L}) be a compact lamination C^r -immersed by i into a manifold M , for $r \geq 1$. Let f be a C^r -diffeomorphism of M such that:*

- f preserves \mathcal{L} and is r -normally hyperbolic at \mathcal{L} ;
- a pull back f^* of f leaves invariant L ($f^*(L) = L$).

Then the immersed lamination is C^r -persistent. If moreover i is an embedding and f is plaque-expansive at (L, \mathcal{L}) then the embedded lamination is C^r -persistent.

We recall the definition of normal hyperbolicity and plaque-expansiveness in sections 2.4.6 and 2.1.3.3 respectively.

A first consequence of the main result is an analogous theorem of the above: we allow f to be an endomorphism, that is to be possibly non-bijective and with singularities, but we suppose f normally expanding instead of normally hyperbolic.

THEOREM 2.1.2. — *Let (L, \mathcal{L}) be a compact lamination C^r -immersed by i into a manifold M . Let f be a C^r -endomorphism of M which preserves and r -normally expands \mathcal{L} . Then the immersed lamination is C^r -persistent. If moreover i is an embedding and f is plaque-expansive at (L, \mathcal{L}) then the embedded lamination is C^r -persistent.*

Let us describe this theorem.

2.1.3.1. Normal expansion. — Let (L, \mathcal{L}) be a lamination and let (M, g) be a Riemannian manifold. Let $f \in \text{End}(M)$ be preserving the lamination (L, \mathcal{L}) immersed by $i \in \text{Im}(\mathcal{L}, M)$. Let f^* be a pullback of f in (L, \mathcal{L}) .

We identify, via the injection given by i , the bundle $T\mathcal{L} \rightarrow L$ to a subbundle of $\pi : i^*TM \rightarrow L$. Thus, \mathcal{L} is endowed with the Riemannian metric i^*g . By commutativity of the above diagram, the endomorphism i^*Tf of $i^*TM \rightarrow i^*TM$, over f^* , preserves the subbundle $T\mathcal{L}$. The action of the endomorphism i^*Tf to the quotient $i^*TM/T\mathcal{L}$ is denoted by

$$[i^*Tf] : i^*TM/T\mathcal{L} \longrightarrow i^*TM/T\mathcal{L}.$$

We notice that the quotient $i^*TM/T\mathcal{L}$ is the normal bundle of \mathcal{L} . We endow this bundle with the norm induced by the Riemannian metric of M : the norm of a vector $u \in i^*TM/T\mathcal{L}$ is the norm of the vector i^*TM which is orthogonal to $T\mathcal{L}$ and represents u .

DEFINITION 2.1.3. — For every $r \geq 1$, the endomorphism f *r -normally expands the lamination (L, \mathcal{L}) (immersed by i over f^*)*, if there exist a continuous function C on L and $\lambda < 1$ such that for all $v \in i^*TM/T\mathcal{L} \setminus \{0\}$ and $n \geq 0$:

$$\max(1, \|T_{\pi(v)}f^{*n}\|)^r \cdot \|v\| < C(x) \cdot \lambda^n \cdot \|[i^*Tf]^n(v)\|.$$

REMARK 2.1.4. — Usually, one supposes L to be compact and C to be constant. This is consistent with this definition, by replacing C by its maximum on L .

DEFINITION 2.1.5. — If the function C is bounded, we say that f *uniformly r -normally expands the lamination (L, \mathcal{L})* .

PROPERTY 2.1.6. — *Let (L, \mathcal{L}) be a lamination immersed by i into a manifold M and 1-normally expanded. Then, for all $x, y \in L$ with the same images by i , the spaces $T_x\mathcal{L}$ and $T_y\mathcal{L}$ are sent by Ti to the same subspace of $T_{i(x)}M$. Thus, we can abuse the notation by denoting $T_{i(x)}\mathcal{L}$ the subspace $Ti(T_x\mathcal{L})$. Moreover, for every compact subset K of L , the section of the Grassmannian $z \in i(K) \rightarrow T_z\mathcal{L}$ is continuous.*

Proof. — By normal expansion at x , the vectors of $Ti(T_y\mathcal{L}) \setminus Ti(T_x\mathcal{L})$ grow exponentially faster than those of $Ti(T_x\mathcal{L})$ and by normal expansion at y , the vectors of $Ti(T_x\mathcal{L}) \setminus Ti(T_y\mathcal{L})$ grow exponentially faster than those of $Ti(T_y\mathcal{L})$. Then the vectors of $Ti(T_y\mathcal{L}) \setminus Ti(T_x\mathcal{L})$ grow and decrease exponentially faster than those of $Ti(T_x\mathcal{L}) \setminus Ti(T_y\mathcal{L})$. Therefore the spaces $Ti(T_x\mathcal{L})$ and $Ti(T_y\mathcal{L})$ are equal.

For any compact subset K of L , the continuity of the map $z \in i(K) \rightarrow T_z \mathcal{L}$ follows from the compactness of K : given a sequence $(z_n) \in i(K)^{\mathbb{N}}$ which converges to some $z \in i(K)$, there exists a sequence $(x_n)_n \in K^{\mathbb{N}}$ sent by i to $(z_n)_n$. By compactness of K , we may suppose that $(x_n)_n$ converges to some $x \in K$. Therefore, by continuity, x is sent by i to z and we have

$$\lim_{n \rightarrow \infty} T_{z_n} \mathcal{L} = \lim_{n \rightarrow \infty} Ti(T_{x_n} \mathcal{L}) = Ti(T_x \mathcal{L}) = T_z \mathcal{L}. \quad \square$$

REMARK 2.1.7. — The above definition of r -normal expansion is equivalent to the following: *there exists $\lambda > 1$ and a continuous positive function C on L such that for every $x \in L$, for all unitary vectors $v_0 \in T_{i(x)} \mathcal{L}$ and $v_1 \in (T_{i(x)} \mathcal{L})^\perp$, for any $n \geq 0$, it holds:*

$$\|p \circ Tf^n(v_1)\| \geq C(x) \cdot \lambda^n \cdot (1 + \|Tf^n(v_0)\|^r),$$

with p equal to the orthogonal projection of $TM|_{i(L)}$ onto $T\mathcal{L}^\perp$.

PROPOSITION 2.1.8. — *Let $r \geq 1$. Let (L, \mathcal{L}) be a lamination immersed by i into a Riemannian manifold (M, g) . Let $f \in \text{End}(M)$, $i \in \text{Im}(\mathcal{L}, M)$, and $f^* \in \text{End}(\mathcal{L})$. If f r -normally expands the immersed lamination \mathcal{L} over f^* , for every compact subset K of L stable by f^* ($f^*(K) \subset K$), there exist a Riemannian metric g' on M and $\lambda' < 1$ such that for the metric i^*g on $T\mathcal{L}$ and the norm induced by g' on i^*TM , it holds for every $v \in (i^*TM/T\mathcal{L})|_K \setminus \{0\}$:*

$$\max(1, \|T_{\pi(v)} f^*\|^r) \cdot \|v\| < \lambda' \cdot \|[i^*Tf](v)\|.$$

We say that g' is a metric adapted to the normal expansion of f on K .

We will prove this proposition in Appendix B.

The following gives a useful geometrical property equivalent to the 1-normal expansion.

PROPERTY 2.1.9. — *Let (L, \mathcal{L}) be a lamination immersed by i into a manifold M . Let $f \in \text{End}^1(M)$ which, for some $r \geq 1$, r -normally expands (L, \mathcal{L}) over $f^* \in \text{End}^1(\mathcal{L})$. Let K be a compact subset of L sent into itself by f^* . Then there exist $\lambda > 1$, a Riemannian metric on M adapted to the r -normal expansion of \mathcal{L} over K and an (open) cone field C on $i(K)$ such that, for every $x \in i(K)$:*

- 1) $T_x \mathcal{L}^\perp$ is a maximal subspace of $T_x M$ contained in C_x ;
- 2) $Tf(\text{cl}(C(x)))$ is included in $C(f(x)) \cup \{0\}$;
- 3) $\|Tf(u)\| > \lambda \cdot \|u\|$ for every $u \in C(x)$.

We will also prove this property in Appendix B.

2.1.3.2. *Persistence of immersed laminations.* — The following result is a particular case of main theorem 2.2.11.

THEOREM 2.1.10. — *Let $r \geq 1$ and let (L, \mathcal{L}) be a lamination C^r -immersed by i into a manifold M . Let f be a C^r -endomorphism of M preserving this immersed*

lamination. Let f^* be a pullback of f and let L' be a precompact open subset of L such that

$$f^*(\text{cl}(L')) \subset L'.$$

If f r -normally expands (L, \mathcal{L}) , then the immersed lamination $(L', \mathcal{L}|_{L'})$ is C^r -persistent. Moreover, there exists a continuous map

$$f' \mapsto (i(f'), f'^*) \in \text{Im}^r(\mathcal{L}, M) \times \text{End}_{f^*}^r(\mathcal{L})$$

defined on a neighborhood V_f of f , such that $i(f)$ is equal to i and such that the following diagram commutes:

$$\begin{array}{ccc} M & \xrightarrow{f'} & M \\ i(f') \uparrow & & \uparrow i(f') \\ L' & \xrightarrow{f'^*} & L' \end{array}$$

Furthermore, off a compact neighborhood W of L' which does not depend on $f' \in V_f$, the maps $i(f')$ and f'^* are equal to i and f^* respectively.

REMARK 2.1.11. — We remark that, every map $f' \in V_f$, close enough to f normally expands the lamination $(L', \mathcal{L}|_{L'})$ immersed by $i(f')$ over f'^* . Hence the hypotheses of the theorem correspond to open conditions on the elements involved.

REMARK 2.1.12. — In the above theorem, the existence of W and the continuity of

$$f' \mapsto (f'^*, i(f')) \in \text{End}_{f^*}^r(\mathcal{L}) \times \text{Im}^r(\mathcal{L}, M)$$

imply its continuity in the strong topology: for any $\epsilon > 0$, for any f' close enough to f and for every $x \in L$, the points $i(x)$ and $i(f')(x)$ are ϵ -distant and the points $f^*(x)$ and $f'^*(x)$ belong to a same plaque of \mathcal{L} with diameter less than ϵ . Similarly, the r -first derivatives of $i(f')$ and f'^* along the leaves of \mathcal{L} are uniformly close to those of i and f^* , for f' close to f .

EXAMPLE 2.1.13. — Let f_1 be a C^r diffeomorphism of a manifold N_1 . Let K be a hyperbolic compact subset. Then, by example 1.1.5, $W^s(K)$ is the image of a lamination (L_1, \mathcal{L}_1) C^r -immersed injectively, whose leaves are the stable manifolds. Let E_u be the unstable direction of K and

$$m := \min_{u \in E_u \setminus \{0\}} \frac{\|Tf(u)\|}{\|u\|} > 1.$$

Let M_2 be a compact Riemannian manifold. Let f_2 be a C^r -endomorphism of M_2 whose differential has norm less than \sqrt{m} (hence f_2 has possibly many singularities and is not necessarily bijective).

Thus, the product dynamics $f := (f_1, f_2)$ on $M := M_1 \times M_2$ r -normally expands the C^r -immersed lamination $(L, \mathcal{L}) := (L_1 \times M_2, \mathcal{L}_1 \times M_2)$ over an endomorphism f^* . Thus, for any precompact subset L' of L , whose closure is sent into itself by f^* (there exist arbitrarily wide such subsets), the lamination $(L', \mathcal{L}|_{L'})$ is C^r -persistent.

2.1.3.3. Plaque-expansiveness

DEFINITION 2.1.14 (Pseudo-orbit). — Let (L, \mathcal{L}) be a lamination and let f be an endomorphism of (L, \mathcal{L}) . Let ϵ be a positive continuous function on L . An ϵ -pseudo-orbit which respects \mathcal{L} is a sequence⁽¹⁾ $(x_n)_{n \geq 0} \in L^{\mathbb{N}}$ such that, for any $n \geq 0$, the point $f(x_n)$ belongs to a plaque of \mathcal{L} containing x_{n+1} with diameter less than $\epsilon(x_{n+1})$.

DEFINITION 2.1.15 (Plaque-expansiveness). — Let ϵ be a positive continuous function on L . The endomorphism f is ϵ -plaque-expansive at (L, \mathcal{L}) if the following condition is satisfied: for any positive continuous function η on L less than ϵ , for all η -pseudo-orbits $(x_n)_n$ and $(y_n)_n$ which respect \mathcal{L} , if for any n the distance between x_n and y_n is less than $\eta(x_n)$, then x_0 and y_0 belong to a same small plaque of \mathcal{L} .

REMARK 2.1.16. — Usually, one supposes L to be compact and ϵ to be constant. This is consistent with this definition by replacing ϵ by its minimum.

REMARK 2.1.17. — We do not know if the normal expansion implies the plaque-expansiveness, even when L is compact. But in many case this is true (see Appendix C).

2.1.3.4. Persistence of embedded laminations. — The following result is a particular case of corollary 2.2.9 of the main theorem.

COROLLARY 2.1.18. — Let $r \geq 1$ and let (L, \mathcal{L}) be a lamination embedded by i into a manifold M . Let f be a C^r -endomorphism of M preserving this embedded lamination. Let f^* be a pullback of f and let L' be a precompact open subset of L such that

$$f^*(\text{cl}(L')) \subset L'.$$

If f r -normally expands (L, \mathcal{L}) and if f^* is plaque-expansive, then the embedded lamination $(L', \mathcal{L}|_{L'})$ is persistent. Moreover there exists a continuous map

$$f' \longmapsto (i(f'), f'^*) \in \text{Em}^r(\mathcal{L}, M) \times \text{End}^r(\mathcal{L})$$

defined on a neighborhood V_f of f , such that $i(f')$ is equal to i and such that the following diagram commutes:

$$\begin{array}{ccc} M & \xrightarrow{f'} & M \\ i' \uparrow & & \uparrow i' \\ L' & \xrightarrow{f'^*} & L' \end{array}$$

Furthermore, off a compact neighborhood W of L' independent of $f' \in V_f$, the maps $i(f')$ and f'^* are equal to i and f^* respectively.

REMARK 2.1.19. — We remark that, every map $f' \in V_f$, close enough to f , normally expands the lamination $(L', \mathcal{L}|_{L'})$ embedded by $i(f')$ and is plaque-expansive. Thus, the hypotheses of the corollary correspond to open conditions on the elements involved.

1. In the diffeomorphism context, as in Hirsch-Pugh-Shub's theorem, sequences are indexed by \mathbb{Z} .

EXAMPLE 2.1.20. — Let $P := x \mapsto x^2 + c$ be expanding on a compact subset K . For instance, c can be a Collet-Eckmann parameter or a hyperbolic parameter. Let $f := (x, y) \in \mathbb{R}^2 \mapsto (x^2 + c, 0)$. The one dimensional embedded lamination $K \times \mathbb{R}$ is r -normally expanded by f for any $r \geq 1$. As this lamination is a bundle, f is obviously plaque-expansive at this lamination. Let $R > 0$ and let

$$L' := K \times] - R, R[.$$

Then this lamination is C^r -persistent. This means that, for any C^r -perturbation f' of f , there exists a C^r -embedding i' of $K \times] - R, R[$ into \mathbb{R}^2 such that f' sends $i'(\{k\} \times] - R, R[)$ into $i'(\{P(k)\} \times] - R, R[)$, and i' is C^r -close to i : i' is uniformly C^0 close to i , the r -first partial derivatives of i with respect to its second coordinate exists, are continuous and are uniformly close to those of i .

2.2. Main result on persistence of stratifications of laminations

2.2.1. Problematics

2.2.1.1. *Embedded stratifications of laminations.* — Throughout this section, we denote by r a fixed positive integer.

Let (A, Σ) be a stratified (laminar) space C^r -embedded by i into a manifold M . We can identify the space (A, Σ) with its image in M .

A C^r -endomorphism f of M *preserves* the stratification (of lamination) Σ if f preserves each stratum of Σ as an embedded lamination.

The stratification Σ is C^r -persistent if every endomorphism f' C^r -close to f preserves a stratified embedding i' of (A, Σ) , C^r -close to i and such that the image by f' of every point $i'(x) \in i'(A)$ belongs to the image by i' of a small plaque containing $f(x)$ (of the stratum containing x). This is equivalent to require the existence of an endomorphism $f'^* \in \text{End}_{f^*}^r(\Sigma)$ close to the restriction $f|_A \in \text{End}^r(\Sigma)$ such that the following diagram commutes:

$$\begin{array}{ccc} M & \xrightarrow{f'} & M \\ i' \uparrow & & \uparrow i' \\ A & \xrightarrow{f'^*} & A \end{array}$$

In particular, this implies also that the dynamics induced by f' and f on the leaves space of each stratum X are the same.

By “close” we meant close for the topologies of $\text{Em}^r(\Sigma, M)$ or $\text{End}_{f^*|_A}^r(\Sigma)$ described in 1.2.4.

If the embedding i is furthermore a -regular and the embedding i' is also a -regular, for every f' close to f , we say that *the a -regular stratification Σ is C^r -persistent*

Our problematics are to found sufficient conditions implying the C^r -persistence of stratifications of laminations.

As we are dealing with endomorphisms, the normal expansion and the plaque-expansiveness of each stratum appear to be good hypotheses.

If we reject the hypothesis of plaque-expansiveness, we shall consider the immersions of stratifications of laminations.

2.2.1.2. Immersed stratifications of laminations. — A stratified (laminar) space (A, Σ) C^r -immersed by i into a manifold M is C^r -preserved by an endomorphism f of M , if there exists an endomorphism $f^* \in \text{End}^r(\Sigma)$ such that the following diagram commutes:

$$\begin{array}{ccc} M & \xrightarrow{f} & M \\ i \uparrow & & \uparrow i \\ A & \xrightarrow{f^*} & A \end{array}$$

Such an endomorphism f^* is the *pullback* of f (into (A, Σ) via i).

This immersed stratified space is C^r -persistent if, for any C^r -endomorphism f' close to f , there exist an immersion i' close to i and an endomorphism $f'^* \in \text{End}_{f^*}^r(\Sigma)$ close to f^* such that the following diagram commutes:

$$\begin{array}{ccc} M & \xrightarrow{f'} & M \\ i' \uparrow & & \uparrow i' \\ A & \xrightarrow{f'^*} & A \end{array}$$

2.2.2. Main result. — Unfortunately, we will see in section 2.3 an example of an embedded (differentiable) compact stratified space, which is normally expanded but not persistent. Therefore some extra hypotheses are required.

We suspect the topology of the stratified space to play a main role.

That is why throughout this section, we fix $r \geq 1$ and we denote by (A, Σ) a stratified space endowed with a C^r -trellis structure \mathcal{T} (such a structure does not exist in the aforementioned example). Moreover M will refer to a Riemannian manifold.

A hypothesis of the main result needs to generalize the notion of pseudo-orbits.

DEFINITION 2.2.1. — Let (L, \mathcal{L}) be a lamination, V an open set of L , f a continuous map from V to L , and ϵ a continuous positive function on V . A sequence $(p_n)_n \in V^{\mathbb{N}}$ is an η -pseudo-orbit of V which respects \mathcal{L} if p_{n+1} and $f(p_n)$ belong to a same plaque of \mathcal{L} with diameter less than $\epsilon(p_{n+1})$, for every $n \geq 0$.

We now state a useful corollary of main theorem 2.2.11.

COROLLARY 2.2.2. — Let i be a \mathcal{T} -controlled C^r -embedding of (A, Σ) into M . We suppose that A is compact. We identify (A, Σ) with its image by i in M . Let f be a C^r -endomorphism of M preserving (A, Σ) . We suppose that for every $X \in \Sigma$:

- (i) f r -normally expands the lamination X ;
- (ii) f is plaque-expansive at X .

There exists a continuous function η on a neighborhood V_X of X satisfying:

- (iii) each plaque of \mathcal{L}_X included in V_X is sent by f into a leaf of \mathcal{L}_X ;
- (iv) every η -pseudo-orbit of V_X which respects \mathcal{L}_X is contained in X .

Then the stratification of laminations (A, Σ) is persistent. Moreover, there exists a family of neighborhoods $(V'_X)_{X \in \Sigma}$ adapted to f such that, for every f' nearby f (for the C^r -compact-open topology), there exists a \mathcal{T} -controlled C^r -embedding i' of (A, Σ) into M , close to i , which is preserved by f' and satisfies for every $X \in \Sigma$:

- (i) f' r -normally expands the lamination X embedded by i' ;
- (ii) f' is plaque-expansive at the lamination X embedded by i' .

There exists a continuous function η' on V'_X satisfying:

- (iii) for every $x \in V'_X$, the endomorphism f' sends $i'(x)$ into the image by i' of the leaf of $f(x)$ in \mathcal{L}_X ;
- (iv) every η' - f' -pseudo-orbits of V'_X , which respects the plaques of the lamination \mathcal{L}_X embedded by i' , is contained in X .

REMARK 2.2.3. — Hypothesis (iii) says that the restriction $f|A$ is a \mathcal{T} -controlled endomorphism and that the family $(V'_X)_X$ is adapted to $f|A$.

REMARK 2.2.4. — The fact that i' is a \mathcal{T} -controlled C^r -embedding i' of (A, Σ) into M , close to i , means that:

- i' is an homeomorphism of A onto its image in M , C^0 -close to the embedding i ;
- for each stratum X , the restriction of i' to L_X is an immersion of the lamination (L_X, \mathcal{L}_X) and the r -first partial derivatives of i' along the plaques of \mathcal{L}_X are close to those of i for the compact-open topology.

REMARK 2.2.5. — Conclusion (iii) says that:

- the pullback f'^* of f' via i' is \mathcal{T} -controlled,
- the family of neighborhoods $\mathcal{V}' = (V'_X)_{X \in \Sigma}$ is adapted to the pull back f'^* of f' ;
- the endomorphism f'^* belongs to the equivalence class $\text{End}_{f|A \mathcal{V}'}^r(\mathcal{T})$ of $f|A$.

Moreover, as f' is close to f and i' close to i , the pull back of f' via i' is close to $f|A$ in the topology of $\text{End}_{f|A \mathcal{V}'}^r(\mathcal{T})$.

REMARK 2.2.6. — Conclusions (i), (ii), (iii) and (iv) imply that the hypotheses of this corollary correspond to open conditions on the elements involved. Moreover, as $(V'_X)_{X \in \Sigma}$ does not depend on f' C^r -close to f , conclusion (iii) appears to be very useful for the proof of the structural stability of non-hyperbolic compact subsets or the persistence of non-normally hyperbolic laminations (see sections 2.4.6 and 2.4.3).

Let us now give some easy applications of this corollary.

EXAMPLE 2.2.7. — Let

$$f : \mathbb{R}^2 \longrightarrow \mathbb{R}^2, \quad (x, y) \longmapsto (x^2, y^2).$$

For any $r \geq 1$, the endomorphism f r -normally expands the canonical stratification Σ on the square $[-1, 1]^2$ formed by the vertices X_0 , the edges X_1 and the interior X_2 . Moreover f is obviously plaque-expansive at each stratum of this stratification. Let $\mathcal{T} = (L_{X_i}, \mathcal{L}_{X_i})_{i=0}^3$ be the trellis structure built in example 1.3.11. We suppose that

L_{X_1} is disjoint from the diagonals of the square. Let V_0 , V_1 and V_2 be equal to respectively

$$L_0 \cap f^{-1}(L_0) \setminus [-\frac{1}{2}, \frac{1}{2}]^2, \quad V_1 \cap f^{-1}(V_1) \setminus [-\frac{1}{2}, \frac{1}{2}]^2, \quad L_2 = X_2.$$

For these settings, hypotheses (i), (ii), (iii) and (iv) are satisfied.

Thus, by corollary 2.2.2, this stratification is C^r -persistent: *for $f' \in \text{End}^r(\mathbb{R}^2)$ close to f , there exists a homeomorphism i' from $[-1, 1]^2$ onto its image in \mathbb{R}^2 , whose restriction to each stratum X_0 , X_1 , X_2 is a C^r -embedding and such that f' preserves the stratification $(i'(X_0), i'(X_1), i'(X_2))$ of $i'([-1, 1]^2)$.* But, as we will see in section 2.4.1, generally $i'([-1, 1]^2)$ is not diffeomorphic to $[-1, 1]^2$.

In fact, in section 2.4 we will systematize this example by showing, on the one hand, the persistence of the canonical stratification of submanifolds with corners normally expanded and, on the other, the persistence of some product stratifications.

EXAMPLE 2.2.8 (Viana map). — Let

$$V : \mathbb{C} \times \mathbb{R} \longrightarrow \mathbb{C} \times \mathbb{R}, \quad (z, h) \longmapsto (z^2, h^2 + c).$$

We fix $c \in]-2, \frac{1}{4}[$. Therefore the map $h \mapsto h^2 + c$ preserves an open interval I and expands its boundary ∂I . Thus, the endomorphism V preserves the stratification Σ of

$$C := \{(z, h) \in \mathbb{C} \times \mathbb{R}; |z| \leq 1 \text{ and } h \in I\}$$

formed by the strata

$$X_0 := \mathbb{S}^1, \quad X_1 := \mathbb{S}^1 \times I, \quad X_2 := \mathbb{D} \times \partial I, \quad X_3 := \mathbb{D} \times I$$

of dimension respectively 0, 1, 2 and 3. We endow (C, Σ) with the trellis structure $\mathcal{T} = (L_{X_i}, \mathcal{L}_{X_i})_{i=0}^3$ described in example 1.3.12.

The endomorphism 1-normally expands each stratum of Σ (see [9] for estimation which implies the 1-normal expansion of X_1). Thus, hypothesis (i) of corollary 2.2.2 is satisfied.

As all the strata are bundles, V is plaque-expansive at each of these laminations (see Appendix C). Thus, hypothesis (ii) is also satisfied.

We notice that $V|_C$ is \mathcal{T} -controlled, hence hypothesis (iii) is satisfied.

Eventually, for an adapted family of tubular neighborhoods small enough, hypothesis (iv) is also satisfied (for any functions η).

Therefore, by corollary 2.2.2, the a -regular stratification Σ is C^1 -persistent.

In other words, for every endomorphism V' C^1 -close to V , there exists a homeomorphism i' of $\text{cl}(\mathbb{D} \times I)$ onto its image in $\mathbb{C} \times \mathbb{R}$, C^0 -close to the canonical inclusion, such that for each stratum $X_k \in \Sigma$:

- the restriction $i'|_{X_k}$ is an embedding of the lamination, close to the canonical inclusion of X_k in $\mathbb{C} \times \mathbb{R}$;
- the lamination $i'(X_k)$ is preserved by V' and, for $x \in X_k$, the point $V' \circ i'(x)$ belongs to the image by i' of a small plaque of X_k containing $V(x)$.

An artistic view of such a perturbation of this stratification is represented figure 4.

More sophisticated applications of this corollary will be given in section 2.4.

The above corollary is an immediate consequence of the following corollary of theorem 2.2.11 (for A compact and $A' = A$). Now A is not supposed to be compact. We now use the notations explain in 1.3.1.

COROLLARY 2.2.9. — *Let i be a \mathcal{T} -controlled C^r -embedding of (A, Σ) into M . Let f be a C^r -endomorphism of M preserving (A, Σ) . We suppose that:*

- (i) $f|_A$ is \mathcal{T} -controlled;
- (ii) f r -normally expands each stratum X ;
- (iii) for every stratum X , there exists a positive continuous function η on a neighborhood V_X of X in A such that every η -pseudo-orbit of V_X , which respects the plaques of \mathcal{L}_X , is contained in X ;
- (iv) f is plaque-expansive at each stratum X .

Let A' be a precompact open subset of A such that $f^*(\text{cl}(A'))$ is included in A' . Then there exist a neighborhood V_f of f in $\text{End}^r(M)$, a family of neighborhoods \mathcal{V} adapted to $f|_{A'}$ and a continuous map

$$V_f \longrightarrow \text{Em}^r(\mathcal{T}|_{A'}, M), \quad f' \longmapsto i(f')$$

with $i(f) = i$ and such that $(f', i(f'))$ satisfies the above properties (i), (ii), (iii) and (iv) for the stratified space $(A', \Sigma|_{A'})$ endowed with the trellis structure $\mathcal{T}|_{A'}$. Moreover, for every $x \in V'_X$, the endomorphism f' sends $i'(x)$ into the image by i' of a small \mathcal{L}_X -plaque containing $f(x)$. In particular $(V'_X)_X$ is adapted to $f'|_{i'(A)}$.

In particular, the stratification $(A', \Sigma|_{A'})$ is persistent.

REMARK 2.2.10. — The continuity of the map $f' \mapsto i(f')$ means that for f' close to f'' in V_f , for any stratum $X \in \Sigma|_{A'}$, any compact subset $K \subset A' \cap L_X$, the elements $i(f')(x)$ and $\partial_{T_x \mathcal{L}_X}^s i(f')$ are uniformly close, for $x \in K$ and $s \in \{1, \dots, r\}$, to respectively $i(f'')(x)$ and $\partial_{T_x \mathcal{L}_X}^s i(f'')$.

The following theorem is the main result of this memoir.

THEOREM 2.2.11. — *Let f be a C^r -endomorphism of M , let i be a \mathcal{T} -controlled C^r -immersion of (A, Σ) into M and let f^* be a \mathcal{T} -controlled C^r -endomorphism such that:*

- (i) the following diagram commutes

$$\begin{array}{ccc} M & \xrightarrow{f} & M \\ i \uparrow & & \uparrow i \\ A & \xrightarrow{f^*} & A \end{array};$$

- (ii) f normally expands each stratum X immersed by $i|_X$ and over $f^*|_X$;
- (iii) for every stratum $X \in \Sigma$, there exist an adapted neighborhood V_X of X and a continuous positive function η on V_X , such that every η -pseudo-orbit of V_X which respects \mathcal{L}_X is contained in X .

Let A' be a precompact open subset of A such that $f^*(\text{cl}(A')) \subset A'$. Then there exist a neighborhood V_f of f in $\text{End}^r(M)$, a family of neighborhoods \mathcal{V}' adapted to $f^*|A'$ and a continuous map

$$V_f \longrightarrow \text{End}_{f^*|A', \mathcal{V}'}^r(\mathcal{T}|A') \times \text{Im}^r(\mathcal{T}|A', M), \quad f' \longmapsto (f'^*, i(f'))$$

with $i(f) = i$ and such that $(f', i(f'), f'^*)$ satisfies the above properties (i), (ii) and (iii) for the stratified space $(A', \Sigma|A')$ endowed with the trellis structure $\mathcal{T}|A'$. In particular, f' preserves the stratification of laminations $\Sigma|A'$ immersed by $i(f')$ and, for every $X \in \Sigma|A'$, each point $x \in V'_X$ is sent by f'^* into a small plaque of \mathcal{L}_X containing $f^*(x)$. In other words, the immersed stratification $\Sigma|A'$ is persistent.

REMARK 2.2.12. — The continuity of the map $f' \mapsto f'^*$ means that for f' C^r -close to f'' in V_f , for any stratum $X \in \Sigma|A'$, any compact subset $K \subset V'_X$, the elements $f'^*(x)$ and $\partial_{T_x \mathcal{L}_X}^s f'^*$ are uniformly close, for $x \in K$ and $s \in \{1, \dots, r\}$, to respectively $f''^*(x)$ and $\partial_{T_x \mathcal{L}_X}^s f''^*$.

QUESTIONS 2.2.13

- The counterexample in 2.3 shows that the existence of a trellis structure, at least locally, seems to be important. However, is it necessary that such a structure controls f^* (or i) to imply the persistence of an embedded stratification? In proof of theorem 2.2.9, this hypothesis is used only in the lemma of 3.5.7. Without this hypothesis this theorem would be much easier to apply to several cases.
- When i is a controlled embedding, is hypothesis (iii) always satisfied? Under the hypotheses of theorem 2.2.11, is this hypothesis necessary? This problem could be a first step to the construction of a counterexample of a normally expanded embedded lamination, but not plaque-expansive.
- Given an a -regular stratification of normally expanded laminations, does the existence of a (local) trellis structure is linked to extra dynamic conditions? For example, given a diffeomorphism that satisfies axiom A and the strong transversality condition, the stratification $(W^s(\Lambda_i))_i$ (see 1.3.2) admits locally a trellis structure.

2.3. A normally expanded but not persistent stratification

Let us present, for all $r \geq 1$, an example of an a -regular compact differentiable stratification with r -normally expanded strata, but not topologically persistent. This means that there exists f' C^∞ -close to f , which does not preserve the image of each stratum by any homeomorphism C^0 -close to the canonical inclusion of the support. We will notice that this stratified space cannot support a trellis structure (even locally).

Let \mathbb{S}^1 be a circle embedded into \mathbb{R}^3 and r -normally hyperbolic for a diffeomorphism f of \mathbb{R}^3 . We suppose that the strong stable dimension is 1. According to [15], the union of the strong stable manifolds of the circle is an immersed manifold, that

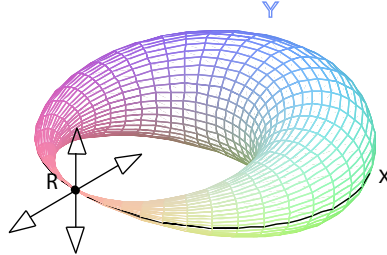

FIGURE 1. Stratification of normally expanded laminations, which is not persistent.

we denote by W^s . We suppose that the point $0 \in \mathbb{R}^3$ is fixed by f and that the restriction of f to $] - 1, 1[$ is equal to

$$f|_{]-1, 1[} :] - 1, 1[\rightarrow \mathbb{R}^3, \quad (x, y, z) \mapsto (x + x^3, 2y, 2z).$$

Thus, the point 0 is topologically repulsive for f . We suppose that W^s without the circle S^1 is contained in the repulsive basin of 0. Therefore, W^s is a manifold embedded into \mathbb{R}^3 .

Let us suppose that the restriction of f to the circle S^1 has a repulsive fixed point and that the stable manifold of this point (in \mathbb{R}^3) intersects $] - 1, 1[$ at $] - 1, 1[\times \{0\}^2 \setminus \{0\}$.

Then the union of 0 with this stable manifold is a circle X differentially C^r -embedded into \mathbb{R}^3 . Let Y be the submanifold $W^s \setminus X$.

We may suppose that the intersection of W^s with

$$\left[-\frac{1}{2} - \frac{1}{8}, -\frac{1}{2} \right] \cup \left[\frac{1}{2}, \frac{1}{8} + \frac{1}{2} \right] \times] - 1, 1[^2$$

is an union of graph of maps from $\left[-\frac{1}{2} - \frac{1}{8}, -\frac{1}{2} \right] \cup \left[\frac{1}{2}, \frac{1}{8} + \frac{1}{2} \right]$ into $] - 1, 1[^2$.

Thus, the partition $\Sigma := (X, Y)$ on $A := X \cup Y$ is an a -regular stratification of \mathbb{R}^3 , r -normally expanded by f . We draw in figure 1 how this stratification looks-like.

If this stratified space (restricted to a neighborhood of 0) could admit a trellis structure, then a small neighborhood of 0 in A would be homeomorphic to the product of a neighborhood of 0 in X with the intersection of A with a plan transverse to X . This last product can be a segment, which is not homeomorphic to any neighborhood of 0 in A , because a segment does not contain any surface.

We suppose, for the sake of contradiction, that the stratification (X, Y) is topologically C^r -persistent. This means that for every diffeomorphism f' C^r -close to f there exists a homeomorphism h , C^0 -close to the canonical inclusion, such that $h(X)$ and $h(Y)$ are f' -stable.

We build now a family of C^∞ -perturbations of f which contradicts this persistence hypothesis. Let ρ be a C^∞ -function with support in $] - 1, 1[$ and such that its restriction to $] - \frac{1}{2}, \frac{1}{2}[$ is equal to 1. For any small $t \geq 0$, let f_t be the diffeomorphism

of \mathbb{R}^3 equal to f on the complement of $] - 1, 1[^3$ and such that its restriction to $] - 1, 1[^3$ is equal to

$$f_t|] - 1, 1[^3 :] - 1, 1[^3 \longrightarrow \mathbb{R}^3, \quad (x, y, z) \longmapsto f(x, y, z) + (-t \cdot \rho(x) \cdot x, 0, 0).$$

We notice that f_0 is equal to f . For t small enough, let $(X(t), Y(t))$ be the f_t -stable stratification given by the persistence hypothesis.

Let us prove that the stratum $X(t)$ is equal to X for t small enough. We note that each diffeomorphism $(f_t)_t$ preserves and 0-normally expands X . Thus, there is a neighborhood V of X such that, for t small enough, the intersection $\bigcap_{n \geq 0} f_t^{-n}(V)$ is equal to X . But, for t small enough, the stratum $X(t)$ is included in V . By f_t -stability of the stratum $X(t)$, we have

$$X(t) \subset \bigcap_{n \geq 0} f_t^{-n}(U) = X$$

since the stratum $X(t)$ is compact, this stratum is a close subset of X . Since this stratum has the same dimension as X , this stratum is an open subset of $X(t)$. Therefore, by connectedness, $X(t)$ is equal to X .

For every $r \in]0, \frac{1}{2}[$ small enough, the set Y only intersects the faces $\{-r\} \times] - r, r[^2$ and $\{r\} \times] - r, r[^2$ of the cube $[-r, r]^3$. The same is satisfied by $Y(t)$, for t small enough.

We can also suppose that t is less than $r^2 < \frac{1}{4}$. This implies that the interval $] - \sqrt{t}, \sqrt{t}[$ is sent into itself by the map

$$\phi_t : x \longmapsto x + x^3 - t \cdot \rho(x) \cdot x.$$

We notice that the restriction $f_t|] - 1, 1[^3$ is equal to $(x, y, z) \mapsto (\phi_t(x), 2y, 2z)$.

The compact set $X \cup Y$ is locally connected and the closure of Y contains X . Since these properties are invariant by homeomorphism, they are also satisfied by $X(t)$ and $Y(t)$.

Thus, there exists a path γ included in $] - \sqrt{t}, \sqrt{t}[\times [-r, r]^2 \cap Y(t)$ and containing $0 \in X = X(t)$ in its closure. We are going to show that the f_t -orbit of γ intersects another face of the cube $[-r, r]^3$ than $\{-r\} \times] - r, r[^2$ and $\{r\} \times] - r, r[^2$. As $Y(t)$ is f_t -stable, this would imply that $Y(t)$ intersects another face of $[-r, r]^3$ than $\{-r\} \times] - r, r[^2$ or $\{r\} \times] - r, r[^2$. This is a contradiction.

As γ is included in the repulsive basin of X , there exists a first integer n such that $f_t^n(\gamma)$ intersects the complement of $] - r, r[^3$. Since the set $] - \sqrt{t}, \sqrt{t}[$ is ϕ_t -stable and r is less than $\frac{1}{2}$, it follows that $f_t^n(\gamma)$ is included in $] - \sqrt{t}, \sqrt{t}[\times] - 1, 1[^2$ and intersects $] - \sqrt{t}, \sqrt{t}[\times (] - 1, 1[^2 \setminus] - r, r[^2)$. As 0 is a fixed point of f_t , it belongs to the closure of $f_t^n(\gamma)$. By connectedness, there exists a point of $f_t^n(\gamma)$ whose second or third coordinate are equal to $-r$ or r . But \sqrt{t} is less than r , so the path $f_t^n(\gamma)$ intersects the boundary of $[-r, r]^3$ at faces different to $\{-r\} \times] - r, r[^2$ or $\{r\} \times] - r, r[^2$.

2.4. Consequences of the main result (theorem 2.2.11)

2.4.1. Submanifolds with boundary

THEOREM 2.4.1. — *Let (M, g) be a Riemannian manifold and let N be a compact C^r -submanifold with boundary of M . Let f be a C^r -endomorphism of M which preserves and r -normally expands the boundary ∂N and the interior $\overset{\circ}{N}$ of N . Then the stratification $(\overset{\circ}{N}, \partial N)$ on N is C^r -persistent.*

REMARK 2.4.2. — In other words, the above theorem concludes that, for any map f' C^r -close to f , there exist two submanifolds $\partial N'$ and $\overset{\circ}{N}'$ such that:

- $\overset{\circ}{N}'$ (resp. $\partial N'$) is preserved by f' , diffeomorphic and close to $\overset{\circ}{N}$ (resp. ∂N) for the compact-open C^1 -topology;
- the pair $(\overset{\circ}{N}', \partial N')$ is a stratification (of laminations) on $N' := \overset{\circ}{N}' \cup \partial N'$;
- the set N' is the image of N by an embedding C^0 -close to the canonical inclusion of N into M .

Idea of proof. — We build a trellis structure on $(N, (\partial N, \overset{\circ}{N}))$ which satisfies properties (iii) and (iv) of corollary 2.2.2. As other properties (i) and (ii) are obviously checked, the corollary implies the C^r -persistence of the stratification. Details of this proof are in [6]. \square

REMARK 2.4.3. — Usually, N' is not a submanifold with boundary.

2.4.2. Submanifolds with corners. — The above theorem can be generalized to submanifold with corners.

We recall that a compact manifold with corners N is a differentiable manifold modeled on \mathbb{R}_+^d . A subset N of manifold M (without corner) is a submanifold with corners if there exist charts $(\phi_\alpha)_\alpha$ of M whose restrictions to respectively $(\phi_\alpha^{-1}(\mathbb{R}^d \times \{0\}))_\alpha$ form an atlas of manifold with corners (for a fixed integer d). For example, a cube, a product of manifolds with boundary or a generic intersection of submanifolds are endowed with canonical structures of manifold with corners.

We denote by $\partial^{0_k} N$ the set of points in N which, seen in a chart, have exactly k coordinates equal to zero. The pair $(N, \Sigma := \{\partial^{0_k} N\})$ is a stratified space.

THEOREM 2.4.4. — *Let N be a compact C^r -submanifold with corners of a manifold M , for $r > 1$. Let f be a C^r -endomorphism of M , which preserves and r -normally expands each stratum $\partial^{0_k} N$. Then the stratification Σ on N is C^r -persistent.*

REMARK 2.4.5. — In other words, the above theorem concludes that, for every endomorphism f' C^r -close to f , there exist submanifolds $(\partial^{0_k} N')_k$ such that:

- for each k , $\partial^{0_k} N'$ is preserved by f' , is diffeomorphic, and is C^r -close to $\partial^{0_k} N$ for the compact-open topology;
- the family $(\partial^{0_k} N')_k$ is a stratification (of laminations) on

$$N' := \bigcup_k \partial^{0_k} N';$$

— the set N' is the image of N by an embedding C^0 -close to the canonical inclusion of N into M .

Idea of proof. — We build a trellis structure on (N, Σ) which satisfies properties (iii) and (iv) of corollary 2.2.2 (this is not easy). As the other properties (i) and (ii) are obviously satisfied, the corollary implies the C^r -persistence of the stratification. The complete proof is in [6]. \square

REMARK 2.4.6. — Usually, N' is not an embedded submanifold with corner.

2.4.3. Extension of the Shub's theorem on conjugacy of repulsive compact set. — The same corollary 2.2.2 implies a complement of M. Shub's celebrated result [30] on the structural stability of expanded compact sets for endomorphisms: the conjugacy between the compact set and its continuation can be extended to a homeomorphism of the ambient space, which is still a conjugacy in the neighborhood of the compact set. C. Robinson already proved a similar result for locally maximal hyperbolic sets of diffeomorphisms.

COROLLARY 2.4.7. — *Let $r \geq 1$, let M be a compact Riemannian manifold, let f be a C^r -endomorphism of M , and let K be a compact subset of M that satisfies*

$$f^{-1}(K) = K.$$

Moreover, we suppose that f expands K , that is, for every $x \in K$, the differential $T_x f$ is invertible with contracting inverse. Then there exists a neighborhood V_K of K such that, for every f' C^r -close to f , there exists a homeomorphism i' of M close to the identity such that

$$\forall x \in V_K, \quad f' \circ i'(x) = i' \circ f(x).$$

Moreover the restriction $i(f')|_{K^c}$ belongs to $\text{Diff}^r(M \setminus K, M \setminus i(f')(K))$ and is C^r -close to the identity (for the compact-open topology).

This corollary is, in a way, the (regular) analogous theorem for endomorphisms of the following (see [28, thm. 4.1]):

THEOREM 2.4.8 (Robinson 1975). — *Let f be a C^1 -diffeomorphism of a compact manifold M . Let K be a compact subset of M which is f -invariant and which has a local product structure. Then there exists a neighborhood V_K of K such that, for f' C^1 -close to f , there exists a homeomorphism h from V_K onto its image, satisfying $h \circ f = f' \circ h$. Moreover, when f' is C^1 -close to f , then h is C^0 -close to the canonical inclusion.*

To show corollary 2.4.7, we will use the following lemma, which will be useful in other context.

LEMMA 2.4.9. — *Let M be a Riemannian n -manifold and let f be a C^1 -endomorphism of M . Let A be a compact subset of M , which is the union of a compact subset K with an open subset X disjoint from K , and such that*

$$K \subset \text{cl}(X), \quad f(K) \subset K, \quad f(X) \subset X$$

Let us suppose that f is expanding on K . We regard K as a 0-dimensional lamination and X as an n -dimensional lamination. Then $(A, (K, X))$ is a stratified space whose canonical embedding is preserved and normally expanded by f , and there exists a trellis structure on it such that hypotheses (i), (ii), (iii) and (iv) of corollary 2.2.2 are satisfied.

REMARK 2.4.10. — As K is a 0-dimensional lamination (and M a C^∞ -manifold), the trellis structure is of class C^r and f r -normally expands the strata K and X , for every $r \geq 1$.

Proof of lemma 2.4.9. — Let us denote by f^* the restriction $f|_A$. Let L_K be a neighborhood of K in A endowed with the 0-dimensional lamination structure \mathcal{L}_K . We recall that X is endowed with the n -dimensional lamination structure. Then (\mathcal{L}_K, X) forms a trellis structure on the stratified space $(A, (K, X))$, which obviously controls f^* and so satisfies hypothesis (iii).

As a ball next to K and included in X has its image by f next to K , included in X but containing a ball of larger radius, there is none orbit of f in a neighborhood V_K of K which is not included in K . We can suppose V_K included in $f^{-1}(L_K) \cap L_K$. As the pseudo-orbits of V_K which respect \mathcal{L}_K are orbits of f in V_K and, as $\bigcap_{n \geq 0} f^{*-1}(V_K)$ is equal to K , hypothesis (iv) of corollary 2.2.2 is satisfied. Moreover, an endomorphism which is expanding on a compact set is necessarily expansive, thus f is plaque-expansive at each stratum K and X . That is why hypothesis (ii) is satisfied. \square

Proof of corollary 2.4.7. — The boundary ∂K of K is f invariant since f is open. We endow the compact subset ∂K with the 0-dimensional lamination structure. Let X be the open subset $M \setminus K$ of M , endowed with the lamination structure of the same dimension as M . Put $A = \partial K \sqcup (M \setminus K) = M \setminus \text{int } K$

We remark that $(A, \Sigma := \{\partial K, X\})$ is a stratified space whose strata are normally expanded. It follows from lemma 2.4.9, that hypotheses (i), (ii), (iii) and (iv) of corollary 2.2.2 are satisfied, for a trellis structure \mathcal{T} on (A, Σ) . This corollary provides a C^r -neighborhood V_f of f and a neighborhood $V'_{\partial K}$ of ∂K such that, for f' C^r -close to f , there exists C^r -embedding i' from (A, Σ) into M , close to the identity, such that conclusion (iii) holds: for any $x \in V_{\partial K}$, the map f' sends $i'(x)$ into the image by i' of the leaf of $f(x) \in L_{\partial K}$. As this leaf is 0-dimensional, we have obtained the conjugacy:

$$\forall x \in V_{\partial K}, \quad f' \circ i'(x) = i' \circ f(x).$$

By shrinking V_f , we can extend i' to K with the conjugacy provided by Shub theorem, since by expansiveness, and the extension of i' to $V_K = V_{\partial K} \cup K$ is injective. We note that $V_K = V_{\partial K} \cup K$ is a neighborhood of K in M and that i' is actually an embedding onto M .

As i' is a stratified embedding C^r -close to the identity, i' is C^0 close to the identity and the restriction $i'|_{K^c}$ is C^r -close to the identity of K^c for the compact-open topology. \square

2.4.4. Product of stratifications of laminations. — The following proposition provides several examples of persistent stratifications in product dynamics.

PROPOSITION 2.4.11. — *Let M , (A, Σ) , \mathcal{T} , f , i and f^* be respectively a manifold, a stratified space, a trellis structure on (A, Σ) , an endomorphism of M , a \mathcal{T} -controlled immersion and a \mathcal{T} -controlled endomorphism that satisfy hypotheses (i) and (iii) of theorem 2.2.11.*

Let M' , (A', Σ') , \mathcal{T}' , f' , i' , and f'^ be respectively a manifold, a stratified space, and a trellis structure on (A', Σ') , an endomorphism of M' , a \mathcal{T}' -controlled immersion and a \mathcal{T}' -controlled endomorphism that satisfy hypotheses (i) and (iii) of theorem 2.2.11.*

We denote by (f, f') and (f^, f'^*) the product dynamics on $M \times M'$ and on $A \times A'$. We denote by (i, i') the immersion of the product stratified space $(A \times A', \Sigma \times \Sigma')$ into $M \times M'$.*

Then there exists a trellis structure $\mathcal{T}_{\text{prod}}$ on the product stratified space such that (f^, f'^*) and (i, i') are $\mathcal{T}_{\text{prod}}$ -controlled and satisfy hypotheses (i) and (iii) with (f, f') .*

Moreover if i and i' are embedding and if f and f' are plaque-expansive at each stratum of respectively Σ and Σ' , then (f, f') is plaque-expansive at each stratum of $\Sigma \times \Sigma'$.

REMARK 2.4.12. — Normal expansion is not a property preserved by product dynamics.

Proof. — Let $\Sigma \times \Sigma'$ be the product stratification on $A \times A'$ defined in 1.2.10 and let $\mathcal{T}_{\text{prod}}$ be the trellis structure defined in 1.3. Let us show that this structure controls (f, f') . For each strata $(X, X') \in \Sigma \times \Sigma'$, there exist neighborhoods V_X and $V_{X'}$ of X and X' adapted to respectively f^* and f'^* . This means that the restrictions $f^*|_{V_X}$ and $f'^*|_{V_{X'}}$ are morphisms from $\mathcal{L}_X|_{V_X}$ and $\mathcal{L}_{X'}|_{V_{X'}}$ to respectively \mathcal{L}_X and $\mathcal{L}_{X'}$. Then the products dynamics (f^*, f'^*) of $A \times A'$ restricted to $V_X \times V_{X'}$ is a morphism from the product lamination $\mathcal{L}_X|_{V_X} \times \mathcal{L}_{X'}|_{V_{X'}}$ to $\mathcal{L}_X \times \mathcal{L}_{X'}$. Let

$$V_{X \times X'} := (V_X \times V_{X'}) \cap L_{X \times X'} \cap (f^*, f'^*)^{-1}(L_{X \times X'})$$

be the adapted neighborhood of $X \times X'$. The product dynamics (f^*, f'^*) restricted to $V_{X \times X'}$ is a morphism from the product lamination $\mathcal{L}_{X \times X'}|_{V_{X \times X'}}$ to $\mathcal{L}_{X \times X'}$, since the lamination $\mathcal{L}_{X \times X'}$ is a restriction of $\mathcal{L}_X \times \mathcal{L}_{X'}$.

Thus, the endomorphism (f^*, f'^*) is $\mathcal{T}_{\text{prod}}$ -controlled.

Let us check hypothesis (iii) of theorem 2.2.11. Let $X \times X'$ be a stratum of $\Sigma \times \Sigma'$. Let η and η' be the functions on respectively V_X and $V_{X'}$ provided by hypothesis (iii). Let η_{prod} be the function on $V_{X \times X'}$ defined by

$$\eta_{\text{prod}} : (x, x') \in V_{X \times X'} \mapsto \min(\eta(x), \eta'(x')).$$

Let $(x_n)_n$ be an η_{prod} -pseudo-orbit of $V_{X \times X'}$ which respects $\mathcal{L}_{X \times X'}$. By projecting canonically to A and A' , we obtain an η -pseudo-orbit of V_X which respects \mathcal{L}_X and an η' -pseudo-orbit of $V_{X'}$ which respects $\mathcal{L}_{X'}$. Hypothesis (iii) implies that these two last pseudo-orbits belong to respectively X and X' . Therefore, the pseudo-orbit $(x_n)_n$ belongs to $X \times X'$. Thus, hypothesis (iii) is satisfied.

We show similarly the plaque-expansiveness. \square

2.4.5. Example of persistent stratifications of laminations in product dynamics

2.4.5.1. *Product of quadratic hyperbolic polynomials.* — Let

$$f : \mathbb{R}^n \longrightarrow \mathbb{R}^n, \quad (x_i)_i \longmapsto (x_i^2 + c_i)_i.$$

We choose $(c_i)_i \in [-2, \frac{1}{4}]^n$, such that the endomorphism $f_i : x \mapsto x^2 + c_i$ has an attractive periodic orbit for each i . Therefore, the trace of the (non filled) Julia set is an expanding compact set K_i .

According to Graczyk-Świątek [14] and Lyubich [18], this is the case for an open and dense set of parameters $(c_i)_i \in [-2, \frac{1}{4}]^n$.

The map $x \mapsto x^2 + c_i$ normally expands the stratification of laminations Σ_i formed by the 0-dimensional lamination supported by K_i and the 1-manifold X_i supported by $\mathbb{R} \setminus K_i$ without its unbounded connected components.

It follows from lemma 2.4.9 that f is a product of maps f_i which satisfy hypotheses (i), (ii), (iii) and (iv) of corollary 2.2.2 with the stratification Σ_i .

We note that the product stratification $\prod \Sigma_i$ is formed by the strata $(Y_J)_{J \subset \{1, \dots, n\}}$, with Y_J the lamination of dimension the cardinal of J and of support

$$\prod_{j \in J} X_j \times \prod_{j \in J^c} K_j.$$

The leaves of Y_J are in the form $\prod_{j \in J} C_j \times \prod_{j \in J^c} \{k_j\}$, with C_j a connected component of X_j and k_j a point of K_j .

Since f r -normally expands the product stratification $\prod \Sigma_i$, by applying $(n - 1)$ -times proposition 2.4.11 and finally corollary 2.2.2, we show the C^r -persistence of this a -regular stratification of laminations, for every $r \geq 1$.

Figure 2 is a numerical experimentation of the persistent stratification of a C^∞ -perturbation of f , for $n = 2$ and $c_1 = c_2 = -1$. The curves form the one-dimensional strata which spiral at each intersection at an exponential speed, that is why this spiraling is imperceptible.

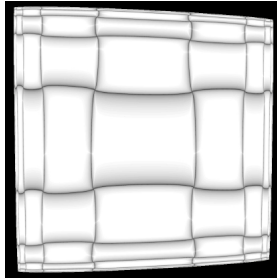

FIGURE 2. Numerical experimentation of the example 2.4.5.2

In dimension two, it is actually J.-C. Yoccoz who remarked the persistence of such a family of curves which spiral at the crossing points. It is this example which motivates the presented theory.

2.4.5.2. *Products of hyperbolic rational functions.* — Let

$$f : \widehat{\mathbb{C}}^n \longrightarrow \widehat{\mathbb{C}}^n, \quad (z_i)_i \longmapsto (R_i(z_i))_i.$$

We assume that R_i is a hyperbolic rational function of the Riemann sphere $\widehat{\mathbb{C}}$ for each i . It follows that its Julia set K_i is an expanded compact subset. The complement X_i of K_i in $\widehat{\mathbb{C}}$ is the union of attraction basins of the attracting periodic orbits. The map R_i normally expands the stratification of laminations Σ_i consisting of the 0-dimensional lamination supported by K_i and of the 2-dimensional lamination supported by X_i .

We notice that the product stratification $\prod_i \Sigma_i$ consists of the strata $(Y_J)_{J \subset \{1, \dots, n\}}$, where the stratum Y_J is of (real) dimension twice the cardinal of J and with support $\prod_{j \in J} X_j \times \prod_{j \in J^c} K_j$. The leaves of Y_J are of the form $\prod_{j \in J} C_j \times \prod_{j \in J^c} \{k_j\}$, with C_j a connected component of $\widehat{\mathbb{C}} \setminus K_j$ and k_j a point of K_j .

For the same reason as above, the a -regular stratification Σ is C^r -persistent, for every $r \geq 1$.

2.4.6. Lamination normally axiom A. — In the diffeomorphism context, we would love to unify two remarkable theorems, that we are going to recall.

The first is the following:

THEOREM 2.4.13 (see Hirsch-Pugh-Shub [15]). — *Let (L, \mathcal{L}) be a compact lamination embedded into a manifold M . Let f be a diffeomorphism of M which leaves invariant and preserves (L, \mathcal{L}) . If f is r -normally hyperbolic and plaque-expansive at \mathcal{L} then the embedded lamination is C^r -persistent.*

We recall that a diffeomorphism *leaves invariant* a lamination (L, \mathcal{L}) if it preserves it and if $f(L) = L$. The definition of plaque-expansiveness in the diffeomorphism context is written in section 2.1.3.3.

Let us be more precise about normal hyperbolicity.

DEFINITION 2.4.14. — Let (L, \mathcal{L}) be a compact lamination embedded into a manifold M . Let f be a diffeomorphism of M leaving invariant (L, \mathcal{L}) . The diffeomorphism f is r -normally hyperbolic to (L, \mathcal{L}) if there exist two subbundles E^s and E^u of the restriction of tangent bundle of M to L , such that:

- E^s and E^u are Tf -invariant;
- $E^s \oplus T\mathcal{L} \oplus E^u = TM|_L$;
- there exists $\lambda < 1$ satisfying for all $x \in L$, $u \in T_x \mathcal{L} \setminus \{0\}$ and $v \in E^u(x)$:

$$\begin{cases} \|T_x f|E^s\| \leq \lambda \cdot \min(1, \|T_x f(u)\|^r / \|u\|^r), \\ \lambda \cdot \|T_x f(v)\| \geq \max(1, \|Tf|T_x \mathcal{L}\|^r) \|v\|. \end{cases}$$

Hence for a zero dimensional lamination K , the normal hyperbolicity of K means that K is hyperbolic. Moreover the persistence of K means that K is structurally stable. But there exist structurally stable diffeomorphisms, that is diffeomorphisms whose C^1 -perturbations are C^0 -conjugated to them, which are not Anosov. Thus, the Hirsch-Pugh-Shub theorem is not optimal. Fortunately, the identification of C^1 -structurally stable diffeomorphism is done, and leads up to the following definition:

DEFINITION 2.4.15. — A diffeomorphism satisfies axiom A and the strong transversality condition (AS) if:

- the nonwandering set Ω is hyperbolic;
- the periodic points are dense in Ω ;
- the intersection of stable and unstable manifolds of points are transverse.

The work of Smale [32], Palis [26], de Melo [22], Mañé [20], Robbin [27] and Robinson [28] have concluded to the following theorem:

THEOREM 2.4.16. — *The diffeomorphisms C^1 -structurally stable of a compact manifold are exactly the AS diffeomorphisms.*

In order to generalize the above two theorems in only one conjecture, let us introduce a last definition:

DEFINITION 2.4.17. — Let (L, \mathcal{L}) be a compact lamination, preserved by a diffeomorphism f of a manifold M . We denote by $\Omega(\mathcal{L})$ the smallest \mathcal{L} -saturated compact subset, which contains the nonwandering set of $f|L$. The lamination \mathcal{L} is *r-normally AS* if:

- there exist $\epsilon > 0$ and a neighborhood U of $\Omega(\mathcal{L})$, such that every ϵ -pseudo-orbit of U which respects \mathcal{L} is included in $\Omega(\mathcal{L})$;
- the lamination $\Omega(\mathcal{L})$ is r -normally hyperbolic and plaque-expansive;
- the stable set of each leaf of $\Omega(\mathcal{L})$ (which is an immersed manifold) intersects transversally the unstable set of every leaf of $\Omega(\mathcal{L})$.

This is our conjecture:

CONJECTURE 2.4.18. — *Every compact r -normally AS lamination is C^r -persistent.*

EXAMPLE 2.4.19. — Let f be an AS diffeomorphism of a manifold M . Let N be a compact manifold. Let \mathcal{L} be the lamination on $M \times N$ whose leaves are written in the form $\{m\} \times N$, for $m \in M$. Let F be the dynamics on $M \times N$ equal to the product of f with the identity of N . Then the lamination \mathcal{L} is normally AS. This conjecture would imply that this lamination is persistent. We can do the same example with a non trivial bundle.

By using main theorem 2.2.11, we have proved in [4] the following theorem:

THEOREM 2.4.20. — *A compact 1-normally AS lamination, whose leaves are the connected components of a C^1 -bundle over a surface is C^1 -persistent.*

REMARK 2.4.21. — This theorem provides non-trivial lamination which are persistent but not normally hyperbolic.

The above theorem can be written in the following equivalent form:

THEOREM 2.4.22. — *Let s be a C^1 -submersion of a compact manifold M onto a compact surface S . Let \mathcal{L} be the lamination structure on M whose leaves are the connected components of the fibers of s . Let f be a diffeomorphism of M which preserves the lamination \mathcal{L} . Let $f_b \in \text{Diff}^1(S)$ be the dynamics induced by f on the leaves spaces of \mathcal{L} . We suppose that:*

- f_b satisfies axiom A and the strong transversality condition;
- the \mathcal{L} -saturated subset generated by the nonwandering set of f in M is 1-normally hyperbolic.

Then \mathcal{L} is C^1 -persistent.

CHAPTER 3

PROOF OF THE PERSISTENCE OF STRATIFICATIONS

3.1. Preliminary

3.1.1. Statements and notations. — Along all this chapter, we work at least under the hypotheses of theorem 2.2.11 with the following notations:

- we denote by n the dimension of M ;
- we denote by $\mathcal{V} = (V_X)_{X \in \Sigma}$ the family of neighborhoods adapted to f^* ;
- we denote by $\Sigma' := \{X_1, \dots, X_N\}$ the set of strata of Σ which intersect $\text{cl}(A')$, indexed such that, for any integers $i \leq j$ of $\{1, \dots, N\}$, if X_i and X_j are incident then $X_i \leq X_j$;
- we denote by d_j the dimension of X_j . To make lighter the notations, we denote by (L_j, \mathcal{L}_j) the tubular neighborhood $(L_{X_j}, \mathcal{L}_{X_j})$ and by V_j the neighborhood V_{X_j} .
- Given a compact subset C , we denote by V_C an open and precompact neighborhood of C , and by (V'_C, \widehat{V}_C) a pair of open subsets that satisfies

$$C \subset V'_C \subset \text{cl}(V'_C) \subset V_C \subset \text{cl}(V_C) \subset \widehat{V}_C$$

We recall that if L_j intersects L_k , then X_j and X_k are incident and, if $j \leq k$, then we have $d_j \leq d_k$.

3.1.2. Construction of an adapted filtration. — We denote by K the compact $\text{cl}(A')$.

PROPERTY 3.1.1. — *There exists a family of compact sets $(K_p)_{p=1, \dots, N+1}$ which satisfies:*

- 3.1.1.1 $K = K_1 \supset K_2 \supset \dots \supset K_{N+1} = \emptyset$ and $f^*(K_p) \subset \text{int}(K_p)$, $\forall p \geq 0$, such that, for all $p \leq N$, with $C_p := \text{cl}(K_p \setminus K_{p+1})$, we have:
- 3.1.1.2 the compact set C_p is included in the adapted neighborhood V_p .
- 3.1.1.3 For any $x \in C_p$, any $u \in \text{Ti}(T_x \mathcal{L}_p)^\perp$, the orthogonal projection of $T_x f(u)$ onto $\text{Ti}(T_{f^*(x)} \mathcal{L}_p)^\perp$ is nonzero.

REMARK 3.1.2. — For all $p \in \{1, \dots, N\}$, the compact set K_p is equal to $\bigcup_{j=p}^N C_j$. It follows from 3.1.1.2 that K_p is included in $\bigcup_{j \geq p} X_j$.

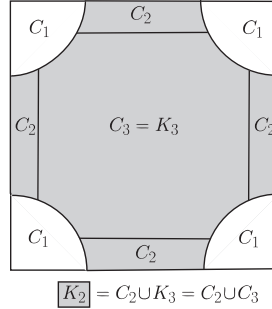

FIGURE 1. Compact sets $(C_k)_k$ for the simplicial stratification of a square, endowed with the trellis structure drawn figure 2.

Proof. — To make lighter the notation, we are going to work along this proof with the topology induced by M on K . Also we abuse notation by denoting $f f^*$ its restriction $f^*|K$.

We will prove the existence of an open neighborhood S_p of $\bigcup_{j \leq p} X_j \cap K$ (in the topology induced by K), that satisfies

$$(1) \quad \emptyset = S_0 \subset S_1 \subset \dots \subset S_N = K \quad \text{and} \quad f^{*-1}(\text{cl}(S_p)) \subset S_p$$

such that $\text{cl}(S_p \setminus S_{p-1})$ can be chosen arbitrarily close to $X_{p+1} \cap K \setminus S_{p-1}$ (the open subset S_{p-1} being fixed) and satisfies

$$(2) \quad \bigcap_{n \in \mathbb{N}} f^{*-n}(S_p) = \bigcup_{j \leq p} X_j \cap K.$$

We define then $K_p := K \setminus S_{p-1}$, for $p \geq 1$. Let us show that (1) and (2) are sufficient to prove this property:

Proof of 3.1.1.1. — The first part is obvious by the first part of (1).

The compact set K is sent by f^* into the interior of K and, following the second inclusion of (1), we have

$$\begin{aligned} K_p = K \setminus S_{p-1} &\subset f^{*-1}(\text{int}(K)) \setminus f^{*-1}(\text{cl}(S_p)) = f^{*-1}(\text{int}(K) \setminus \text{cl}(S_p)) \\ &\implies f^*(K_p) \subset \text{int}(K) \setminus \text{cl}(S_p) = \text{int}(K_p). \end{aligned}$$

Proof of 3.1.1.2. — The compact set C_p is equal to $\text{cl}(S_p \setminus S_{p-1})$, which can be chosen arbitrarily close to the compact set $X_p \cap K_p = X_p \cap K \setminus S_{p-1}$, which is included in V_p .

Proof of 3.1.1.3. — By normal expansion, for any $x \in K \cap X_p \setminus S_{p-1}$, any $u \in Ti(T_x \mathcal{L}_p)$, the orthogonal projection of $T_x f(u)$ onto $Ti(T_x \mathcal{L}_p)^\perp$ is nonzero. By compactness, statement 3.1.1.3 is then satisfied if C_p is nearby $X_p \cap K_p$.

Proof of (1) and (2). — Let us construct, by induction on $p \in \{0, \dots, N\}$, the subset S_p which satisfies (1) and (2). For the rest of the proof, we deal with the topology induced by \tilde{K} .

Let p be an integer that satisfies the induction hypothesis. Let $U := (K \cap V_{p+1}) \cup S_p$. Following (2), every orbit which starts in $U \cap K$ without $\tilde{K} := K \cap (\bigcup_{j \leq p+1} X_j)$ leaves definitively S_p and, by theorem 2.2.11 (iii), leaves also V_{p+1} . As the set $f^{*-1}(\tilde{K})$ is equal to \tilde{K} , we have

$$\bigcap_{n \geq 1} f^{*-n}(U) = \tilde{K}.$$

Let V_0 be a compact neighborhood of \tilde{K} in U . We have also

$$\bigcap_{n \geq 1} f^{*-n}(V_0) = \tilde{K}.$$

By compactness, there exists $M \geq 0$ such that $\bigcap_{n=1}^M f^{*-n}(V_0)$ is included in V_0 . We now define

$$V_1 := \bigcap_{n=0}^M f^{*-n}(V_0).$$

The compact set V_1 has its preimage by f^* which is included into itself. The decreasing sequence of preimages of V_1 converges to \tilde{K} . Moreover, V_1 is a neighborhood of \tilde{K} (for the topology induced by K). We would like the preimage $f^{*-1}(V_1)$ to be included into the interior of V_1 . This requires the construction of a new neighborhood.

There exists $M' > 0$ such that $f^{*-M'}(V_1)$ is included in the interior of V_1 . We chose a family of open subsets $(V^i)_{i=0}^{M'-1}$ that satisfies

$$\text{int}(f^{*-M'}(V_1)) =: V^0 \subset \text{cl}(V^0) \subset V^1 \subset \text{cl}(V^1) \subset V^2 \subset \dots \subset V^{M'-1} := \text{int}(V_1).$$

Let us define the following open neighborhood of \tilde{K} in V_0 :

$$V_2 := \bigcup_{n=0}^{M'-1} f^{*-n}(V^n)$$

We easily check that the preimage by f^* of $\text{cl}(V_2)$ is included in V_2 , and that

$$\bigcap_{n \geq 0} f^{*-n}(V_2) = \tilde{K}$$

Let us define $S_{p+1} := V_2 \cup S_p$, which is a neighborhood of \tilde{K} and satisfies (1). Moreover, $f^{*-k}(S_{p+1})$ is equal to $f^{*-k}(V_2) \cup f^{*-k}(S_p)$, thus $\bigcap_{n \geq 0} f^{*-n}(S_{p+1})$ is equal to $K \cap (\bigcup_{\ell \leq p+1} X_\ell)$, which is (2). The hypothesis is satisfied with $\text{cl}(S_{p+1} \setminus S_p)$ arbitrarily close to $K \cap X_{p+1} \setminus S_p$, by replacing S_{p+1} by $f^{*-n}(S_{p+1}) \cup S_p$. \square

3.1.3. Uniformity of exiting chains. — Let (L, \mathcal{L}) be a lamination, let V be a subset of L and let f^* be a continuous map from V to L . A ϵ -pseudo-chain of V which respects \mathcal{L} is a sequence $(p_n)_{n=0}^m \in V^{m+1}$ such that, for all $n \in \{0, \dots, m-1\}$, the points p_{n+1} and $f^*(p_n)$ are in a same plaque of \mathcal{L} of diameter less than ϵ . We say that $(p_n)_{n=0}^m \in L^{m+1}$ starts from p_0 , arrives to p_m , and is of length m .

PROPERTY 3.1.3. — Let $p \in \{1, \dots, N\}$ and let η be the function on V_p associated to X_p in hypothesis (iii) of theorem 2.2.11. For every open subset V , precompact in V_p , and every real $\eta' \in]0, \inf_V \eta[$, we have

$$\bigcup_{j \geq 0} \text{int}(U_j) = V \setminus X_p$$

with U_j the subset of points $x \in V_p$ such that there is no η' -pseudo-chain of V , which respects \mathcal{L}_p , starts from x and of length j .

Proof. — It is sufficient to prove that, for every $x \in V \setminus X_p$, there exists $j \geq 0$ such that x belongs to the interior of U_j . Let W be a compact neighborhood of x included in $V \setminus X_p$. Let W_n be the subset V consisting of the arriving points of η' -pseudo-orbits of V , of length n , starting from $x' \in W$, and which respects \mathcal{L}_p .

If for n large enough, the subset W_n is empty, then x belongs to the interior of U_n . Otherwise, we show a contradiction: there exists then a family $((x_i^k)_{i=0}^{N_k})_k$ of η' -pseudo-chains of V which respect \mathcal{L}_p , start from W , and such that $(N_k)_k$ converges to the infinity. We complete $(x_i^k)_{i=0}^{N_k}$ to a family $(x_i^k)_{i \in \mathbb{N}} \in V^{\mathbb{N}}$ with $x_i^k := x$ for every $i > N_k$. As V is precompact in V_p , by diagonal extraction, a subsequence converges to an η -pseudo-orbit of V_p which respects \mathcal{L}_p and starts at $x' \in W$. As x' belongs to $V_p \setminus X_p$, this η -pseudo-orbit is included in $V_p \setminus X_p$. This contradicts hypothesis (iii) of theorem 2.2.11. \square

3.2. Proof to corollary 2.2.9

Let $V_{A'}$ be a neighborhood of $\text{cl}(A')$, such that $f^*(\text{cl}(V_{A'}))$ is included into A' . By applying theorem 2.2.11 with $V_{A'}$ instead of A' , we may suppose that $f' \mapsto f'^*$ is a continuous map from V_f to $\text{End}_{f^*, \mathcal{V}'}(\mathcal{T}|V_{A'})$. Nevertheless, we continue to use all the notations and statements of the preceding sections.

Let $(K_p)_p$ be the compact sets family provided by property 3.1.1. Let us show, by decreasing induction on p , that by taking V_f sufficiently small, the map $i(f')|K_p$ is injective, for every $f' \in V_f$. Therefore, the restriction $i(f')|K$ is a homeomorphism onto its image and $i(f')|A'$ is a $\mathcal{T}|A'$ -controlled embedding.

For $p = N$, we first remark that K_N is a compact subset of X_N . Let $\epsilon > 0$ be less than the minimum on K_N of the plaque-expansiveness function of X_N . By taking ϵ sufficiently small, we may suppose that restricted to any X_N -plaque intersecting K_N and with diameter less than ϵ , the map $i(f')$ is injective, for every $f' \in V_f$.

We notice that the following map is continuous:

$$\phi : V_f \longrightarrow \mathbb{R}^+, \quad f' \longmapsto \min_{\substack{(z, z') \in K_N^2 \\ d(z, z') \geq \epsilon}} d(i(f')(z), i(f')(z')).$$

As $\phi(f)$ is positive, by taking V_f sufficiently small, we may suppose that ϕ is positive on V_f . Let $(x, y) \in K_N^2$ and $f' \in V_f$ be such that $i(f')(x) = i(f')(y)$. By commutativity of the diagram, this implies that, for every $n \geq 0$, the points $i(f')(f'^{*n}(x))$ and $i(f')(f'^{*n}(y))$ are equal. It follows from 3.1.1.1 and from the continuity of the extension of $f' \mapsto i(f')$ that, by taking V_f sufficiently small, the points $f'^{*n}(y)$ and $f'^{*n}(x)$ belong to K_N , for every $n \geq 0$. As $\phi(f')$ is positive, this implies that the points $f'^{*n}(y)$ and $f'^{*n}(x)$ are ϵ -distant. By taking V_f sufficiently small, $(f'^{*n}(x))_n$ and $(f'^{*n}(y))_n$ are ϵ -pseudo-orbits which respect the lamination X_N . By plaque-expansiveness and injectivity of the restriction of $i(f')$ to the ϵ - X_N -plaques, x and y are equal. This implies that the restriction of $i(f')$ to K_N is injective, for every $f' \in V_f$.

We suppose the injectivity shown on K_{p+1} . By proceeding as in the step $p = N$, one shows that the restriction of $i(f')$ to the compact set $K_p \cap X_p$ is injective, for every $f' \in V_f$. Let $(x, y) \in K_p^2$ and $f' \in V_f$ be satisfying:

$$i(f')(x) = i(f')(y).$$

For V_f sufficiently small, we may suppose that, for every $f'' \in V_f$, the compact sets $i(f'')(K_p \cap X_p)$ and $i(f'')(K_{p+1})$ are disjoint, and $f''^*(K_p)$ is contained in K_p .

If x belongs to X_p , by commutativity of the diagram, we have

$$\begin{aligned} \forall n \geq 0, \quad i(f') \circ f'^{*n}(x) &= i(f') \circ f'^{*n}(y) \\ \implies \forall n \geq 0, \quad f'^{*n}(y) &\in K_p \setminus K_{p+1} \subset C_p. \end{aligned}$$

By the compactness of C_p in V_p , for V_f sufficiently small, the sequence $(f'^{*n}(y))_n$ is an η -pseudo-orbit which respects \mathcal{L}_p , with η the function on V_p provided by hypothesis (iii) of theorem 2.2.11. Therefore, following this hypothesis (iii), y belongs to $X_p \cap C_p$. Thus, x and y are equal.

Let us treat the case where neither x nor y belongs to X_p . We fix a compact neighborhood V_{C_p} of C_p in V'_p , and we note that:

1) By taking V_f sufficiently small, it follows from the local inversion theorem and from the compactness of V_{C_p} that there exists $\epsilon > 0$ which does not depend on $f' \in V_f$, such that the restriction of $i(f')$ to any plaque of \mathcal{L}_p , with diameter less than ϵ and nonempty intersection with V_{C_p} , is an embedding.

2) By taking ϵ and then V_f sufficiently small, it follows from 3.1.1.3 that there exists $\epsilon > 0$ such that for any pair $(x', y') \in V_{C_p}^2$ satisfying $f'^*(x') = f'^*(y')$ and $d(x', y') < \epsilon$, the points x and y belong to a same plaque of \mathcal{L}_p whose diameter is less than ϵ . We can suppose moreover that the open set V_{C_p} contains the ϵ -neighborhood of C_p .

3) We notice that the following map is continuous:

$$\phi : V_f \longrightarrow \mathbb{R}^+, \quad f' \longmapsto \min_{\substack{(z, z') \in K_p^2 \\ d(z, z') \geq \epsilon}} d(i(f')(z), i(f')(z')).$$

As $\phi(f)$ is positive, by taking V_f sufficiently small, for every $f' \in V_f$, the real number $\phi(f')$ is also positive.

Since $i(f')(x)$ is equal to $i(f')(y)$, by commutativity of the diagram, for every $n \geq 0$, the point $i(f') \circ f'^{*n}(x)$ is equal to $i(f') \circ f'^{*n}(y)$. It follows from 3) that, for $n \geq 0$, we have $d(f'^{*n}(x), f'^{*n}(y)) < \epsilon$.

By taking V_f sufficiently small, it follows from hypothesis (iii) and 3.1.1.2, as neither x nor y belongs to X_p , that there exists a minimal integer M such that $f'^{*M}(x)$ and $f'^{*M}(y)$ belong to K_{p+1} . Using the induction hypothesis, the point $f'^{*M}(x)$ is equal to $f'^{*M}(y)$. Moreover, by definition of M , the points $f'^{*M-1}(x)$ and $f'^{*M-1}(y)$ belong to the ϵ -neighborhood of C_p and so to V_{C_p} . Using 2) then 1), we have

$$f'^{*M-1}(x) = f'^{*M-1}(y).$$

By decreasing induction, using 3), then 2), and finally 1), we have

$$\forall n \leq N, f'^{*n}(x) = f'^{*n}(y).$$

Thus, x and y are equal. \square

3.3. Fundamental property of dynamics on K_p

The following fundamental property implies main theorem 2.2.11, and will be shown by decreasing induction on p .

FUNDAMENTAL PROPERTY 3.3.1. — *For every $p \in \{1, \dots, N+1\}$, there exist:*

- a real $\eta' > 0$ and a neighborhood V_f of $f \in \text{End}^r(M)$, both arbitrarily small;
- an open neighborhood A_p of K_p , which is precompact in $\bigcup_{q \geq p} X_q$ and whose closure is sent by f^* into $\text{int}(K_p)$;
- a family of neighborhoods $\mathcal{V}^p := (V_X)_{X \in \Sigma|_{A_p}}$ adapted to $f^*|_{A_p}$;
- a continuous map

$$V_f \longrightarrow \text{End}_{f^*|_{A_p, \mathcal{V}^p}}^r(\mathcal{T}|_{A_p}) \times \text{Mor}^r(\mathcal{T}, M), \quad f' \longmapsto (f_p^*, i_p(f'))$$

that satisfy:

- 1) $f_p^* = f^*|_{A_p}$ and $i_p(f) = i$;
- 2) the following diagram commutes

$$\begin{array}{ccc} M & \xrightarrow{f'} & M \\ i_p(f') \uparrow & & \uparrow i_p(f') \\ A_p & \xrightarrow{f_p^*} & A_p \end{array};$$

- 3) the restriction of $i_p(f')$ to A_p is an immersion;
- 4) for every $j \geq p$, the subset $V_{X_j^p}$ is a neighborhood of C_j , and for all $x \in V_{X_j^p}$ and $f' \in V_f$, the point $f_p^*(x)$ belongs to the set⁽¹⁾ $\mathcal{L}_{j f_p^*(x)}^{\eta'}$.

1. We recall that \mathcal{L}_y^δ denote the union of the plaques of \mathcal{L}_j containing $y \in L_j$ and of diameter less than $\delta > 0$.

The link between η' and V_f is the following: η' will be chosen small enough, then V_f will be chosen small enough regarding to η' .

3.4. Fundamental property implies main theorem 2.2.11

Let us show that, for $p = 1$, the above property implies theorem 2.2.11. For every $j \geq 1$, we denote by X'_j the stratum of $\Sigma|A'$ associated to X_j .

As $\text{cl}(A')$ is a compact subset included in A_1 sent by f^* into A' , by taking η' and V_f sufficiently small, we may suppose that, for all $f' \in V_f$, we have

$$d(A'^c, f'^*(A')) > \eta'.$$

Therefore, it follows from fundamental property 3), that we can define the following continuous map:

$$\begin{aligned} V_f &\longrightarrow \text{End}_{f^*|A', \mathcal{V}'}^r(\mathcal{T}|A') \times \text{Im}^r(\mathcal{T}|A', M), \\ f' &\longmapsto (f'^* := f'_1{}^*|A', i(f') := i_1(f')|A') \end{aligned}$$

with $V_{X'_j} := V_{X_j} \cap A'$ and $\mathcal{V}' := (V_X)_{X \in \Sigma|A'}$ for $j \geq 1$.

Conclusion (i) of theorem 2.2.11 is a simple consequence of fundamental property 2).

Conclusion (iii) of theorem 2.2.11 for the stratum X'_p can be shown by induction on $p \geq 1$.

For every $p \geq 1$, by restricting $V_{X'_p}$, we may suppose that $V_{X'_p} \cap K_p$ is precompact in V_p . We may also suppose that η' is less than the minimum on $V_{X'_1} \cap K_p$ of the function η associated to X_p in hypothesis (iii).

The step $p = 1$ is then obvious. We now consider $p > 1$.

As K_p is sent by f^* into its interior, by taking V_f and η' sufficiently small, every η' - f'^* -pseudo-orbit of $V_{X'_p}$, which respects \mathcal{L}_p , and starts in $V_{X'_p} \cap K_p$ is included in K_p , and by hypothesis (iii), is necessarily included in X_p .

In the other hand, by taking V_f sufficiently small, it follows from 3.1.1.1 that we have

$$(3) \quad A' \cap K_p \subset \text{int}(f'^{*^{-1}}(A' \cap K_p))$$

and we can show that

$$(4) \quad \bigcup_{n \geq 0} f'^{*^{-n}}(A' \cap K_p) \supset V_{X'_p}.$$

Because, otherwise there exists $x \in V_{X'_p}$ having its f'^* -orbit which does not intersect K_p . Let $q < p$ be maximal such that the orbit of x intersects C_q . The point x cannot belong to X_q ; so its orbit leaves necessarily C_q , by the hypothesis of induction, fundamental property 4) and the choice of η' . On the other hand, the orbit of x intersects K_q , so eventually lands in K_q but does not intersect K_p . Therefore its orbit intersects $C_{q'}$ with $p > q' > q$. This is a contradiction with the maximality of q .

By (3) and (4), we can build a continuous and positive function η'' on $V_{X'_p}$, which is less than η' and such that: for all $n \geq 1$, $x \in f'^{*^{-n}}(A' \cap K_p) \cap V_{X'_p}$, and

$x_1 \in V_{X'_p} \cap \mathcal{L}_{pf'^*(x)}^{\eta''(x)}$, the set $V_{X'_p} \cap \mathcal{L}_{pf'^*(x_1)}^{\eta''(x_1)}$ is included in $f'^{*n+1}(A' \cap K_p) \cap V_{X'_p}$. Such a function η'' satisfies conclusion (iii) of theorem 2.2.11, because all η'' -pseudo-orbits of f'^* in $V_{X'_p}$ belong eventually to $V_{X'_p} \cap K_p$.

Only the proof of conclusion (ii) remains. By fundamental properties 2), 3), and 4), the lamination X'_p is immersed by $i(f')$ and preserved by $f' \in V_f$, for every $p \geq 1$. By continuity of $f' \mapsto (i_1(f'), f'^*)$ and the r -normal expansion, we may restrict V_f such that the endomorphism f' uniformly r -normally expands the lamination X'_p over the compact set $X_p \cap K_p$. It follows from (3) and (4), that the endomorphism f' r -normally expands the immersed lamination X'_p . Thus, conclusion (ii) of theorem 2.2.11 is satisfied.

3.5. Proof of fundamental property

We proceed by decreasing induction on p .

By taking $A_{N+1} := \emptyset$, $V_f := \text{End}^r(M)$, and $i(f') := i$ for every $f' \in V_f$, step $p = N + 1$ is obviously satisfied. Let us suppose the fundamental property satisfied for $p + 1 \leq N$.

The proof proceeds by a graph transformation which needs a tubular neighborhood to be defined.

In appendix A.2.2, we will show the following:

PROPOSITION 3.5.1. — *There exists a lifting $F_p : x \in L_p \mapsto F_{px}$ of $i|_{L_p}$ into the Grassmannian of $n - d_p$ -plans of TM which is $\mathcal{T}|_{L_p}$ -controlled and C^0 -close to $x \mapsto Ti(T_x \mathcal{L}_p)^\perp$.*

By lifting we mean that $F_{px} \subset T_{i(x)}M$, for every $x \in L_p$. As F_{px} is close to $Ti(T_x \mathcal{L}_p)^\perp$, we assume it in direct sum with $Ti(T_x \mathcal{L}_p)$.

Let F_p be the union $\bigcup_{x \in L_p} F_{px}$ endowed with a natural vector bundle structure over L_k . We endow this bundle with the norm induced by the Riemannian metric on M .

We denote by \exp the exponential map associated to a complete Riemannian metric on M . Let $\epsilon \in C^\infty(M, \mathbb{R}_*^+)$ be a positive function less than the injectivity radius of the exponential map. Let

$$\text{Exp} : i^*TM \longrightarrow M, \quad (x, v) \longmapsto \exp_{i(x)} \left(\epsilon \circ i(x) \cdot \frac{v}{\sqrt{1 + \|v\|^2}} \right).$$

For all $p \in \{1, \dots, N\}$ and $x \in L_p$, let \mathcal{F}_{px} be the submanifold $\text{Exp}(F_{px})$ and let $\mathcal{F}_{px}^{\eta'}$ be the submanifold $\text{Exp}(B_{F_{px}}(0, \eta'))$.

Naively, the idea of the proof is, for every $f' \in V_f$, to glue $i_{p+1}(f')$ with its pull back given by the following graph transformation:

LEMMA 3.5.2. — *By restricting η' and then V_f , there exist an open precompact neighborhood \widehat{V}_{C_p} of C_p in V_p such that, for any small neighborhood \widehat{A}_p of K_p , there*

exist a neighborhood V_i of $i|\widehat{A}_p \in \text{Mor}^r(\mathcal{T}|\widehat{A}_p, M)$ and a continuous map

$$S^0 : V_f \times V_i \longrightarrow \text{Mor}^r(\mathcal{T}|\widehat{V}_{C_p}, M)$$

satisfying:

- 1) the morphism $S^0(f, i|\widehat{A}_p)$ is equal to $i|\widehat{V}_{C_p}$, for all $x \in L_p$ and $f' \in V_f$;
- 2) the preimage of $i'(\mathcal{L}_{pf^*(x)}^{\eta'})$ by f' intersects $\mathcal{F}_{px}^{\eta'}$ at a unique point $S^0(f', i')(x)$, for all $f' \in V_f$ and $i' \in V_i$.
Let $f_{i'}^*(x) \in \mathcal{L}_{pf^*(x)}^{\eta'}$ be defined by $f' \circ S^0(f', i')(x) = i'(f_{i'}^*(x))$.
- 3) If i' is a controlled immersion around $f_{i'}^*(x)$, then $S_0(f', i')(x)$ is a controlled immersion around x .

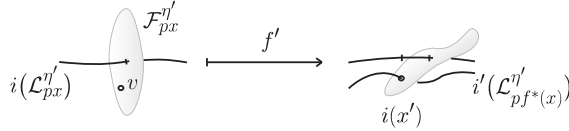

FIGURE 2. Definition of S^0

3.5.1. Proof of lemma 3.5.2. — A small neighborhood \widehat{V}_{C_p} of C_p is precompact in V_p . We may suppose $\eta' > 0$ and the compact neighborhood $\text{cl}(\widehat{V}_{C_p})$ small enough such that, by 3.1.1.3, the restriction of f' to $\mathcal{F}_{px}^{\eta'}$ is a diffeomorphism onto its image, and this image intersects transversally at a unique point the image of the plaque $\mathcal{L}_{pf^*(x)}^{\eta'}$ by i' , for all $x \in \text{cl}(\widehat{V}_{C_p})$, i' C^r -close to i and f' C^r -close to f . Writing this intersection point in the form

$$f'(v) = i'(x'),$$

we define (see figure 2)

$$f_{i'}^*(x) := x' \in \mathcal{L}_{pf^*(x)}^{\eta'}, \quad S^0(f', i')(x) := v \in \mathcal{F}_{px}^{\eta'}.$$

Such a map S^0 satisfies conclusions 1) and 2) of lemma 3.5.2. Let us show that S^0 takes continuously its values in the set of morphisms from the lamination $\mathcal{L}_p|\widehat{V}_{C_p}$ into M .

3.5.1.1. *Well definition and continuity of*

$$(f', i') \in V_f \times V_i \mapsto S^0(f', i') \in \text{Im}(\mathcal{L}_p|\widehat{V}_{C_p}, M)$$

Let $x \in \text{cl}(C_p)$ and let $(U_y, \phi_y) \in \mathcal{L}_p|\widehat{V}_{C_p}$ be a chart of a neighborhood of $y := f^*(x)$. We may suppose that ϕ_y can be written in the form

$$\phi_y : U_y \longrightarrow \mathbb{R}^{d_p} \times T_y$$

where T_y is a locally compact metric space. Let (u_y, t_y) be defined by

$$\phi_y(y) =: (u_y, t_y).$$

We remark that \mathbb{R}^{d_p} is C^r -immersed by $\psi := u \in \mathbb{R}^{d_p} \mapsto i \circ \phi^{-1}(u, t_y)$.

As we saw, the endomorphism f , restricted to a small neighborhood of $i(x)$, is transverse to the above immersed manifold, at $z := f \circ i(x)$. In other words,

$$Tf(T_x M) + T\Psi(T_{u_y} \mathbb{R}^{d_p}) = T_z M.$$

Thus, by transversality, there exist open neighborhoods V_{u_y} of $u_y \in \mathbb{R}^d$ and $V_{i(x)}$ of $i(x) \in M$ such that the preimage by $f|V_{i(x)}$ of $\psi(V_{u_y})$ is a C^r -submanifold. Moreover, such a submanifold depends continuously on f and ψ , with respect to the C^r -topologies.

More precisely, there exist neighborhoods V_{u_y} of u_y , V_f of $f \in \text{End}^r(M)$, V_ψ of $\psi \in C^r(\mathbb{R}^{d_p}, M)$, and $V_{i(x)}$ of $i(x)$ such that, for all $f' \in V_f$ and $\psi' \in V_\psi$, the map $f'|V_{i(x)}$ is transverse to $\Psi'|V_{u_y}$ and the preimage by $f'|V_{i(x)}$ of $\psi'(V_{u_y})$ is a manifold which depends continuously on f' and ψ' , in the compact-open C^r -topologies.

There exist neighborhoods V_{t_y} of t_y in T_y and V_i of $i \in \text{Im}^r(\mathcal{T}, M)$, such that

$$\psi_{i',t} : u \in \mathbb{R}^d \longmapsto i' \circ \phi(u, t)$$

belongs to V_ψ , for all $t \in T_y$ and $i' \in V_i$.

Thus, the preimage by every $f' \in V_f$, restricted to $V_{i(x)}$, of the plaque $\mathcal{L}_t := \phi_y^{-1}(V_{u_y} \times \{t\})$, immersed by $i' \in V_i$, depends C^r -continuously on f' , i' and t' .

Let (U_x, ϕ_x) be a chart of a neighborhood of x . Let us suppose that ϕ_x can be written in the form

$$\phi_x : U_x \longrightarrow \mathbb{R}^{d_p} \times T_x$$

where T_x is a locally compact metric space. We define

$$(u_x, t_x) := \phi_x(x) \text{ and } x_t := \phi_x^{-1}(u_x, t), \quad \forall t \in T_x.$$

For $V_{i(x)}$ and then $\eta' > 0$ and U_x small enough, the manifolds $(\mathcal{F}_{px'}^{\eta'})_{x' \in \mathcal{L}_{px_t}^{\eta'}}$ are open subsets of leaves of a C^r -foliation on $V_{i(x)}$, which depends C^r -continuously on $t \in T_x$. We may suppose U_x small enough to have its closure sent by f^* into $\phi_y^{-1}(V_{u_y} \times V_{t_y})$.

For all $\eta' > 0$ and then V_i and V_f small enough, each submanifold $\mathcal{F}_{px'}^{\eta'}$ intersects transversally at a unique point the submanifold $f'^{-1}|V_{i(x)}(i'(\mathcal{L}_{t'}))$, where t' is the second coordinate of $\phi_y \circ f^*(x')$ and x' belongs to U_x . As we know $S^0(f', i')(x')$ is this intersection point.

In other words, $S^0(f', i')|_{\mathcal{L}_{x_t}^{\eta'}}$ is the composition of i with the holonomy along the C^r -foliation $(\mathcal{F}_{px'}^{\eta'})_{x' \in \mathcal{L}_{px_t}^{\eta'}}$, from $i(\mathcal{L}_{px_t}^{\eta'})$ to the transverse section $f'^{-1}|V_{i(x)}(i'(\mathcal{L}_{t'}))$, where t' is the second coordinate of $\phi_y \circ f^*(x_t)$.

Thus, the map $S^0(f', i')$ is of class C^r along the \mathcal{L}_p -plaque contained in U_x . As these foliations and manifolds vary C^r -continuously with $x' \in U_x$, the map $S^0(f', i')$ is a $\mathcal{L}_p|U_x$ -morphism into M .

These foliations and manifolds also depend C^r -continuously on $x' \in U_x$, $i' \in V_i$, and $f' \in V_f$. Thus, the map

$$S^0 : (f', i') \in V_f \times V_i \longmapsto S^0(f', i')$$

is continuous into $\text{Mor}^r(\mathcal{L}_p|U_x, M)$.

As, C_p is compact, we get a finite open covers of C_p by such open subsets U_x on which the restriction of S^0 satisfies the above regularity property. By taking V_i and V_f small enough to be convenient for all the subsets of this finite covers, we get the continuity of the following continuous map:

$$S^0 : (f', i') \in V_f \times V_i \longmapsto S^0(f', i') \in \text{Mor}^r(\mathcal{L}_p|\widehat{V}_{C_p}, M)$$

where \widehat{V}_{C_p} is the union of the open covers of C_p .

As $S^0(f, i) = i$ is an immersion and S^0 is continuous, by restricting a slice \widehat{V}_{C_p} , and by restricting V_f and V_i , we may suppose that S^0 takes its values in the set of immersions from $\mathcal{L}_p|\widehat{V}_{C_p}$ into M .

3.5.1.2. *Well definition and continuity of*

$$(f', i') \in V_f \times V_i \mapsto S^0(f', i') \in \text{Mor}(\mathcal{T}|\widehat{V}_{C_p}, M)$$

We regard now the \mathcal{T} -controlled properties of i' and f^* . This supplementary regularity will imply that $S^0(f', i')$ is $\mathcal{T}|\widehat{V}_{C_p}$ -controlled without restricting V_i and V_f .

We recall that $S^0(f', i')$ has been defined by transversality on a finite union of distinguish open sets U_x for \mathcal{L}_p .

As $\widehat{V}_{C_p} \subset L_p$ is included in the union of the strata $(X_j)_j$, for every $j > p$, the set $U_x \cap X_j$ is included in the union of distinguish open sets U_j for the foliation of laminations $\mathcal{L}_p|L_p \cap L_j$ of $\mathcal{L}_j|L_p \cap L_j$.

This means that the restriction of the \mathcal{L}_p -chart ϕ_x of U_x restricted to U_j is equivalent to a chart:

$$\phi_j : U_j \longrightarrow \mathbb{R}^{d_p} \times \mathbb{R}^{d_j-d_p} \times T_j$$

which is also a chart of \mathcal{L}_j .

Also, we can suppose such U_j included in the adapted neighborhood V_j . Furthermore, by property 1.3.15, we can suppose that U_j is $\mathcal{L}_p|U_x$ -saturated: all the \mathcal{L}_p -plaques included in U_x and intersecting U_j are included in U_j .

We recall that the distinguish open subset U_x was sent into the distinguish open subset U_y by f^* , with all the room needed to make work the transversality argument defining $S^0|U_x$. Remember that $\phi_y : U_y \rightarrow \mathbb{R}^{d_p} \times T_y$ denotes a \mathcal{L}_p chart of U_y .

Let ψ be the continuous map from $\mathbb{R}^{d_j-d_p} \times T_j$ to T_y equal to the second component of the morphism:

$$\phi_y \circ f^* \circ \phi_j^{-1} : \mathbb{R}^{d_p} \times \mathbb{R}^{d_j-d_p} \times T_j \longrightarrow \mathbb{R}^{d_p} \times T_y.$$

As U_j is included in the adapted neighborhood V_j , the image of U_j by f^* is included into L_j .

By Property 3.1.1.3, for every $t \in T_j$, the union $\bigcup_{v \in \mathbb{R}^{d_j-d_p}} \mathcal{L}_{\psi(v,t)}$ is a \mathcal{L}_j -plaque, with $\mathcal{L}_{t'} := \phi_y^{-1}(\mathbb{R}^{d_p} \times \{t'\})$ for every $t' \in T_y$.

As every $i' \in V_i$ is \mathcal{T} -controlled, the following union is a C^r submanifold of $\mathbb{R}^{d_j-d_p} \times M$:

$$\bigcup_{v \in \mathbb{R}^{d_j-d_p}} \{v\} \times i'(\mathcal{L}_{\psi(v,t)}).$$

We recall that for $x' \in U_x$, $i' \in V_i$, $t' \in T_y$ and $f' \in V_f$, the map f' is transverse to $i'(\mathcal{L}_{t'})$ at a neighborhood of $S^0(f', i')(x')$. Consequently, for every $t \in T_j$, $v \in \mathbb{R}^{d_j-d_p}$,

the product of the identity of $\mathbb{R}^{d_j-d_p}$ with f' is transverse to $\{v\} \times i'(\mathcal{L}_{\psi(v,t)})$ at a neighborhood of $S^0(f', i')(x')$. This implies that:

$$\mathcal{M}_{i', f', t} := \bigcup_{v \in \mathbb{R}^{d_j-d_p}} \{v\} \times f'^{-1}(i'(\mathcal{L}_{\psi(v,t)})),$$

intersected with neighborhood of $i'(x')$ is a C^r -submanifold of dimension d_j .

As $f'^{-1}(i'(\mathcal{L}_{\psi(v,t)}))$ is transverse to $\mathcal{F}_{px'}$, the above union is transverse to $\{v\} \times \mathcal{F}_{px'}$, for every $v \in \mathbb{R}^{d_j}$. By control of $N_p|\widehat{V}_{C_p}$, the family

$$\mathcal{F}_t := (\{v\} \times \mathcal{F}_{px'})_{\{(v,x') \in \mathbb{R}^{d_j-d_p} \times U_j : \phi_{ij}(x') \in \mathbb{R}^{d_p} \times \{v,t\}\}}$$

is a C^r foliation, for every $t \in T_j$.

By holonomy along \mathcal{F}_t from $\mathcal{M}_{i', f', t}$ to $\bigcup_{v \in \mathbb{R}^{d_j-d_p}} \{v\} \times i \circ \phi_j^{-1}(\mathbb{R}^{d_p} \times \{v,t\})$, we get that $S^0(f', i')$ restricted to $\phi_j^{-1}(\mathbb{R}^{d_j} \times \{t\})$ is of class C^r .

As moreover this foliations and the transverse sections vary continuously with $t \in T_j$, $f' \in V_f$, $i' \in V_i$, the map:

$$(f', i') \in V_f \times V_i \longmapsto S^0(f', i')|U_j \in \text{Mor}(\mathcal{L}_j|V_j, M)$$

is well defined and continuous.

As we did not have to shrink V_i nor V_f , we can do the same argument for every $j \geq p$ and U_j to get the continuity and well definition of

$$(f', i') \in V_f \times V_i \mapsto S^0(f', i') \in \text{Mor}(\mathcal{T}|\widehat{V}_{C_p}, M)$$

By using tools defined later, we will proof in section 3.6 that conclusion 3) holds. \square

In order to satisfy statements 2) and 4) of the fundamental property, we have to pay attention on the way we glue $i_{p+1}(f')$ and $i'_p(f') := S^0(f', i_{p+1}(f'))$, for f' close to f .

We shall begin by studying the combinatorial topology.

3.5.2. Topological study. — This is the “gluing area”:

LEMMA 3.5.3. — *Let Δ be the compact subset $C_p \cap K_{p+1}$. There exists an open neighborhood V_Δ of Δ , arbitrarily small which is precompact in $\widehat{V}_{C_p} \cap A_{p+1}$ and such that:*

- (i) $f^*(\text{cl}(V_\Delta))$ is included in $\text{int}(K_{p+1} \setminus V_\Delta)$;
- (ii) $f^*(\text{cl}(A_{p+1}))$ is disjoint from $\text{cl}(V_\Delta)$.

Proof. — As Δ is included in K_{p+1} , the open subset A_{p+1} is a neighborhood of Δ . Since Δ is included in C_p the open subset \widehat{V}_{C_p} is a neighborhood of Δ . Thus, a small neighborhood of Δ is included in $\widehat{V}_{C_p} \cap A_{p+1}$.

As Δ is included in K_{p+1} , the endomorphism f^* sends Δ into $\text{int}(K_{p+1})$, by 3.1.1.1. Moreover, Δ is included in $C_p \subset \text{cl}(K_{p+1}^c)$. Thus, a small neighborhood V_Δ of Δ satisfies (i).

Since Δ is included in $\text{cl}(K_{p+1}^c)$ and since, by the induction hypothesis, $f^*(\text{cl}(A_{p+1}))$ is included in $\text{int}(K_{p+1})$, a small neighborhood V_Δ of Δ satisfies (ii). \square

Let V'_Δ be an open subset of A that satisfies

$$\Delta \subset V'_\Delta \subset \text{cl}(V'_\Delta) \subset V_\Delta.$$

PROPERTY 3.5.4. — For each $j \geq p$, there exist two precompact open neighborhoods V'_{C_j} and V_{C_j} of C_j , that satisfy $\text{cl}(V'_{C_j}) \subset V_{C_j}$, such that with

$$A_p := \bigcup_{j \geq p} V'_{C_j} \text{ and } A'_{p+1} := \bigcup_{j > p} V_{C_j},$$

we have:

- 3.5.4.0 A_p and A'_{p+1} are neighborhoods of K_p and K_{p+1} respectively; moreover, A'_{p+1} is included in A_{p+1} ;
- 3.5.4.1 f^* sends $\text{cl}(A_p \cup V_{C_p})$ into $\text{int}(K_p)$ and f^* sends $\text{cl}(A_{p+1})$ into $\text{int}(K_{p+1}) \setminus \text{cl}(V_{C_p} \cup V_\Delta)$;
- 3.5.4.2 $\text{cl}(V_{C_j}) \subset V_{X_j^{p+1}}$, for every $j > p$, and $\text{cl}(V_{C_p}) \subset \widehat{V}_{C_p}$,
- 3.5.4.3 for any $x \in \widehat{V}_{C_p}$, any $u \in \text{Ti}(T_x \mathcal{L}_p)^\perp$, the orthogonal projection of $T_x f(u)$ onto $\text{Ti}(T_{f^*(x)} \mathcal{L}_p)^\perp$ is nonzero;
- 3.5.4.4 the intersection $\text{cl}(V_{C_p}) \cap \text{cl}(A'_{p+1})$ is included in V'_Δ ;
- 3.5.4.5 we have $V_{C_p} \cup A'_{p+1} \cup \text{int}(A_p^c) = A$.

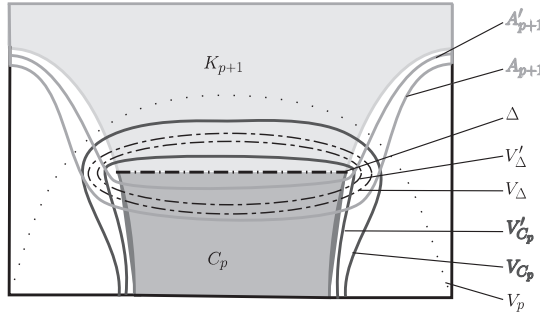

FIGURE 3. This new figure summaries all the new notations with: $A_p \subset \widehat{A}_p = A'_{p+1} \cup V_{C_p}$, $A_p = \bigcup_{j \geq p} V'_{C_j}$ and $A'_{p+1} = \bigcup_{j > p} V_{C_j}$

Proof. — Since the union of compact subsets $(C_j)_{j \geq p}$ is equal to K_p and since the union of compact subsets $(C_j)_{j \geq p+1}$ is equal to K_{p+1} , we easily get statement 3.5.4.0. When the neighborhoods $(V_{C_j})_{j \geq p}$ are small, the neighborhoods A_p and A'_{p+1} are close to respectively K_p and K_{p+1} . Thus, for $(V_{C_j})_{j > p}$ small enough, the subset A'_{p+1} is included in the open set A_{p+1} given by the inductive fundamental property.

The first part of 3.5.4.1 follows from 3.1.1.1 for $(V'_{C_j})_{j \geq p}$ and V_{C_p} small enough. The second part of 3.5.4.1 is true for V_{C_p} and V_Δ small enough, by the fundamental property which states that the compact subset $\text{cl}(A_{p+1})$ is sent into the interior of \widehat{K}_{p+1} .

Inclusions 3.5.4.2 is a consequence of fundamental property 4), for $(V_{C_j})_{j \geq p}$ small enough.

Inequality 3.5.4.3 is a consequence of 3.1.1.3, for \widehat{V}_{C_p} and V_Δ small enough.

To obtain statement 3.5.4.4, we fix V'_Δ , then we take neighborhoods $(V_{C_j})_{j \geq p}$ small enough.

Statement 3.5.4.5 is obvious. \square

We fix now definitively $(V_{C_j})_{j \geq p}$, $(V'_{C_j})_{j \geq p}$, \widehat{V}_{C_p} , V_Δ , and $V_{\Delta'}$.

3.5.3. Gluing lemma. — The idea of the proof is to glue $i_{p+1}(f')$ to $i'_p := S^0(f', i_{p+1}(f'))$ over V_Δ , and then to reapply lemma 3.5.2 and so on. We will prove then that such a sequence converges to a certain controlled morphism $i_p(f')$.

In order to satisfy fundamental property 4), we have to take care on the way of gluing. We must connect $i_{p+1}(f')(x)$ to $i'_p(f')(x)$ along the submanifold

$$i_{p+1}(f')(\mathcal{L}'_{jx}), \forall j > p, x \in V_{C_j} \cap \widehat{V}_{C_p} \text{ and } f' \in V_f.$$

The above intersections are well transverse by taking η' and then V_f sufficiently small.

Let us show that $i'_p(f')(x)$ belongs to $i_{p+1}(f')(\mathcal{L}'_{jx})$. It follows from conclusion 2) of lemma 3.5.2, that the point $i'_p(f')(x)$ is sent by f' into $i_{p+1}(f')(\mathcal{L}'_{pf^*(x)})$.

By taking η' smaller, the distance $d(f^*(V_{C_j}), L_j^c)$ is greater than $2\eta'$. Thus, by coherence of tubular neighborhoods, the plaque $\mathcal{L}'_{pf^*(x)}$ is included in $\mathcal{L}'_{jf^*(x)}$.

$$(5) \quad \implies f'(i'_p(f')(x)) \in i_{p+1}(f')(\mathcal{L}'_{jf^*(x)}).$$

By transversality, the component of $f'^{-1}(i_{p+1}(f')(\mathcal{L}_{jf^*(x)}))$ containing $i'_p(f')(x)$ is a manifold of dimension d_j . By fundamental property 2) and property 3.5.4.2:

$$i'_p(f')(x) \in i_{p+1}(f')(\mathcal{L}'_{jx}).$$

This is the gluing lemma:

LEMMA 3.5.5. — *By taking $\eta' > 0$ smaller and then V_f smaller, there exist a neighborhood G of the graph of $i|V_\Delta$ and a continuous map*

$$\gamma : V_f \longrightarrow \text{Mor}^r((\mathcal{T} \times M)|G \times [0, 1], M)$$

such that, for all $f' \in V_f$ and $(x, y) \in G$:

- 1) $\gamma(f')(x, y, 0)$ is equal to $i_{p+1}(f')(x)$;
- 2) for every $t \in [0, 1]$, the point $\gamma(f')(x, y, t)$ belongs to $i_{p+1}(f')(\mathcal{L}'_{jx})$, if x belongs to V'_{C_j} ;

- 3) if y belongs to $i_{p+1}(f')(\mathcal{L}'_{jx})$ for every $j > p$ such that x belongs to V'_{C_j} , then $\gamma(f')(x, y, 1)$ is equal to y .

Lemma 3.5.5 will be proved in section 3.6.7.

Let us proceed with the gluing lemma. Let $\rho \in \text{Mor}^r(\mathcal{T}, [0, 1])$ be a function with support in V_Δ and equal to 1 on V'_Δ . By taking V_f sufficiently small, we may define

$$i^0(f') : A \longrightarrow M, \quad x \longmapsto \begin{cases} \gamma(f')(x, i'_p(f')(x), \rho(x)) & \text{if } x \in V_\Delta, \\ i_{p+1}(f')(x) & \text{if } x \in V'_\Delta. \end{cases}$$

Since the support of ρ is included in V_Δ , by statement 1) of lemma 3.5.5, the map i^0 is continuous from V_f into $\text{Mor}^r(\mathcal{T}, M)$.

By statement 3) of lemma 3.5.5, the morphism i^0 is equal to i'_p on $\text{cl}(V'_\Delta)$ and to i_{p+1} on the complement of V_Δ .

PROPERTY 3.5.6. — *By restricting η' and then V_f , we may suppose that, for all $f' \in V_f$, $j > p$ and $x \in V'_{C_j}$:*

3.5.6.1 *the point $f' \circ i^0(f')(x)$ belongs to $i^0(f')(\mathcal{L}'_{jf^*(x)})$;*

3.5.6.2 *the point $i^0(f')(x)$ belongs to $i_{p+1}(f')(\mathcal{L}'_{jx})$.*

Proof. — Statement 3.5.6.2 is an obvious consequence of conclusion 2) of lemma 3.5.5, let us show statement 3.5.6.1.

For every $x \in V'_{C_j} \setminus V_\Delta$, the points $i^0(f')(x)$ and $i_{p+1}(f')(x)$ are equal. It follows from fundamental property 2), that the points $f' \circ i_{p+1}(f')(x)$ and $i_{p+1}(f') \circ f'^*_{p+1}(x)$ are equal. Since x belongs to A_{p+1} , by restricting V_f , the point $f'^*_{p+1}(x)$ never belongs to V_Δ , thus the points $i_{p+1}(f') \circ f'^*_{p+1}(x)$ and $i^0(f') \circ f'^*_{p+1}(x)$ are equal. Finally, by fundamental property 4) and property 3.5.4.2, the point $f'^*_{p+1}(x)$ belongs to $\mathcal{L}'_{jf^*(x)}$. Hence

$$\begin{aligned} f' \circ i^0(f')(x) &= f' \circ i_{p+1}(f')(x) = i_{p+1}(f') \circ f'^*_{p+1}(x) \\ &= i^0(f') \circ f'^*_{p+1}(x) \in i^0(f')(\mathcal{L}'_{jf^*(x)}). \end{aligned}$$

By statement 2) of lemma 3.5.5, for all $x \in V_\Delta \cap V'_{C_j}$ and $f' \in V_f$, the point $i^0(f')(x)$ belongs to $i_{p+1}(f')(\mathcal{L}'_{jx})$. Moreover, the points $i^0(f')(x)$ and $i(x)$ are equal. Thus, by taking V_f sufficiently small, f' sends $i^0(f')(x)$ into $i_{p+1}(f')(\mathcal{L}'_{jf^*(x)})$.

By the first statement of lemma 3.5.3, the image of $\text{cl}(V_\Delta)$ by f^* is disjoint from $\text{cl}(V_\Delta)$. Thus, on a neighborhood of $f^*(V_\Delta)$, the morphism i^0 is equal to i_{p+1} . Therefore, for η' and V_f small enough, the images of $\mathcal{L}'_{jf^*(x)}$ by $i^0(f')$ and by $i_{p+1}(f')$ are equal.

Therefore, $i_{p+1}(f')(\mathcal{L}'_{jf^*(x)}) = i^0(f')(\mathcal{L}'_{jf^*(x)})$ contains the image by f' of the point $i^0(f')(x)$, for any $x \in V_\Delta \cap V'_{C_j}$. \square

Let us show, for all $f' \in V_f$, $q > p$, and $x \in A_{p+1} \cap L_q$, that the differential $\partial_{T_x \mathcal{L}_q} i^0(f')$ is injective. By fundamental property 3), it is sufficient to check this

for $x \in V_\Delta$. By fundamental property 3) and property 3.5.6.2, it is sufficient to prove that $\partial_{T_x \mathcal{L}_j} i^0(f')$ is injective for every $j > p$ such that $x \in V_{C_j}$. For $f' = f$, the morphism $i^0(f')$ is equal to i , thus $\partial_{T_x \mathcal{L}_j} i^0(f')$ is injective. Since V_{C_j} is precompact in L_j and since the map $i_p^0|_{L_j}$ is continuous from V_f into $\text{Mor}^1(\mathcal{L}_j, M)$, by restricting V_f , the differential $\partial_{T_x \mathcal{L}_j} i^0(f')$ is always injective.

3.5.4. Definition of $(i^k)_k$. — Let \widehat{A}_p be equal to $A'_{p+1} \cup V_{C_p}$. By property 3.5.4.5, \widehat{A}_p is a neighborhood of $\text{cl}(A_p)$. Let

$$\begin{aligned} \mathcal{M}_p &:= \{j \in \text{Mor}^r(\mathcal{T}|\widehat{A}_p, M) : j(x) \in \mathcal{F}_{px}, \forall x \in L_p\}, \\ \mathcal{M}_p^{f'} &:= \{j \in \mathcal{M}_p, j|_{A'_{p+1}} = i^0(f')|_{A'_{p+1}}\}. \end{aligned}$$

Let \mathcal{M} be the following set

$$\prod_{f' \in V_f} \{f'\} \times \mathcal{M}_p^{f'}$$

endowed with the topology induced by $\text{End}^r(M) \times \text{Mor}^r(\mathcal{T}|\widehat{A}_p, M)$.

We notice that $(f', i^0(f')|_{\widehat{A}_p})$ belongs to \mathcal{M} , for every $f' \in V_f$.

We are going to define i_p , by induction and by using the following lemma proved in section 3.6:

LEMMA 3.5.7. — *There exists a neighborhood $V_{f,i}$ of $(f, i) \in \mathcal{M}$ such that the following map is well defined and continuous:*

$$S : V_{f,i} \longrightarrow V_{f,i}, \quad (f', j) \longmapsto (f', S_{f'}(j)),$$

where $S_{f'}(j)$ is equal to $i^0(f')$ on A'_{p+1} and equal to $S^0(f', i')$ on V_{C_p} . Moreover S satisfies, for all $(f', j) \in V_{f,i}$:

- 1) For every $x \in V_{C_p}$, the point $S_{f'}(j)(x)$ is the unique intersection point of $\mathcal{F}_{px}^{\eta'}$ with the preimage by f' of $j(\mathcal{L}_{pf^*(x)}^{\eta'})$.

Let $f_j^{f'*}(x) \in \mathcal{L}_{pf^*(x)}^{\eta'}$ defined by

$$f' \circ S_{f'}(j) = j \circ f_j^{f'*}(x).$$

- 2) For all $k \geq p$ and $x \in V_{C_p} \cap X_k$, if $\partial_{TX_k} j$ is injective at $f_j^{f'}(x)$, then $\partial_{TX_k} S_{f'}(j)$ is also injective at x .
- 3) For the distance⁽²⁾ defining the strong topology of C^r -morphism from the immersed lamination \mathcal{L}_p , for every $\delta > 0$, there exist a neighborhood $V_{f'}$ of $f' \in V_f$ and $M > 0$ such that for every $f'' \in V_{f'}$, we have

$$\text{diam}_{\mathcal{L}_p} \{j|_{V_{C_p}} : (f'', j) \in S_{f''}^M(V_{f,i})\} < \delta.$$

2. See section 1.1.4.

For V_f sufficiently small, we can now define, for all $k > 0$, the continuous map

$$i^k : f' \in V_f \mapsto S_{f'}^k(i^0(f')) \in \text{Mor}^r(\mathcal{T}, M).$$

We are going to prove that, for every $f' \in V_f$, the sequence $(i^k(f'))_k$ converges to a morphism $i_p^\infty(f') \in \text{Mor}^r(\mathcal{T}|\widehat{A}_p, M)$. Then $i_p(f')$ will be equal to $i_p^\infty(f')$ on A_p and to i on the complement of \widehat{A}_p .

3.5.5. Convergence of $(i^k)_k$ to i_p . — Let us describe the values of i_p^k on V_{C_p} , for every $f' \in V_f$.

By conclusion 1) of lemma 3.5.7, for every $x \in V_{C_p}$, the point

$$i^k(x) = S_{f'}(i_p^{k-1}(f'))(x)$$

depends only on $i^{k-1}(x_1)$, where $x_1 := f_{i^{k-1}(f')}^*(x)$ is η' -close to $f^*(x)$ in a plaque of \mathcal{L}_p . By 3.5.4.1, the map f^* sends $\text{cl}(V_{C_p})$ into $\text{int}(K_p)$, thus we may suppose that x_1 belongs to K_p .

If moreover x_1 belongs to A_{p+1}^c , then x_1 belongs to $K_p \setminus A_{p+1}' \subset V_{C_p}$. Then, we can iterate this process which constructs an η' -pseudo chain $(x_i)_{i=0}^{n_x}$ of f^* , which respects the plaques of \mathcal{L}_p , defined by

$$(6) \quad \begin{cases} x_0 = x, \\ x_{i+1} := f_{i^{k-i-1}(f')}^*(x_i) \text{ and } f' \circ i^{k-i}(f')(x_i) = i^{k-i-1}(f')(x_{i+1}) \end{cases}$$

that we stop when i is equal to k or x_i belongs to A_{p+1}' . Therefore, we have $x_0 = x, \dots, x_i \in K_p \setminus A_{p+1}', \dots, x_{n_x} \in A_{p+1}' \cap K_p$ or $n_x = k$.

We are going to prove that

$$(7) \quad \forall x \in V_{C_p}, \quad i^k(f')(x) = S_{f'}^{n_x}(i^0(f'))(x).$$

For $n_x = k$, this equality is the definition of i^k .

For $n_x < k$, by 3.5.4.4, the point x_{n_x} belongs to A_{p+1}' thus, $i^{k-n_x}(f')(x_{n_x}) = i^0(f')(x_{n_x})$ and so $i^k(f')(x) = i^0(f')(x)$.

We remark that n_x does not change for a greater k and that $x \mapsto n_x$ is upper semi continuous since A_{p+1}' is open and the maps f_{ij}^* are continuous.

Also, for every $x \in \widehat{A}_p \setminus X_p$, the sequence $(i^k(f')(x))_k$ is eventually locally constant, by hypothesis (iii) of the theorem, for η' and then V_f sufficiently small.

Let us now define i_p . It follows from conclusion 3) of lemma 3.5.7 and from the description of the values of $(i^k)_k$, that this sequence converges in $C^0(V_f, C^0(\widehat{A}_p, M))$, to a certain map i_p^∞ .

Let $r \in \text{Mor}^r(\mathcal{T}, [0, 1])$ be equal to 1 on the η' -neighborhood of A_p and to 0 on a neighborhood of the complement of \widehat{A}_p (we may reduce η' if necessary). Let

$$i_p := f' \in V_f \mapsto \left[x \in A \mapsto \begin{cases} \text{Exp}(r(x) \cdot \text{Exp}_{i(x)}^{-1}(i_p^\infty(x))) & \text{if } x \in \widehat{A}_p \\ i(x) & \text{otherwise} \end{cases} \right].$$

3.5.6. Properties of i_p . — Let us begin by showing that i_p is a continuous map from V_f into $\text{Mor}^r(\mathcal{T}, M)$. As the restriction of i_p^∞ to A'_{p+1} is a continuous map from V_f into $\text{Mor}^r(\mathcal{T}|A'_{p+1}, M)$, and as i and r are \mathcal{T} -controlled C^r -morphisms, the restriction of i_p to A'_{p+1} is a continuous map from V_f into $\text{Mor}^r(\mathcal{T}|A'_{p+1}, M)$.

It follows from conclusion 3) of lemma 3.5.7 that the restriction of i_p to V_{C_p} is continuous from V_f into $\text{Mor}^r(\mathcal{L}_p|V_{C_p}, M)$.

By taking η' small enough, we may suppose this constant less than $\inf_{V_{C_p}} \eta$, where η is the function on V_p provided by hypothesis (iii) of the theorem. We define U_j as the interior of the subset of points in V_{C_p} which are not the starting point of any η' -pseudo-chain of V_{C_p} which respects \mathcal{L}_p and with length j . By property 3.1.3, the sequence of open subsets $(U_j)_j$ is increasing and its union is equal to $V_{C_p} \setminus X_p$. It follows from the description of the values of $(i^k)_k$ that, for $k > j$, the morphism $i^k(f')$ and $i_p^\infty(f')$ are equal on U_j . Thus, i_p is continuous from V_f into $\text{Mor}^r(\mathcal{T}, M)$.

Let us prove that i_p satisfies fundamental property 3): *the restriction of $i_p(f')$ to A_p is an immersion, for every $f' \in V_f$.*

By definition of i_p , on a neighborhood of $A'_{p+1} \cap A_p$, the map $i_p(f')$ is equal to $i^0(f')$. We recall that A'_{p+1} is included in A_{p+1} and that we showed that $i_p^0(f')|A_{p+1}$ is an immersion. Thus, $i_p(f')|A'_{p+1}$ is an immersion.

Let us now study the restriction of $i_p(f')$ to $V'_{C_p} \setminus A'_{p+1}$ which is equal to $A_p \setminus A'_{p+1}$. Let $x \in (V'_{C_p} \setminus (X_p \cup A'_{p+1}))$. We regard as before the pseudo-chain $(x_k)_{k=0}^{n_x}$ which respects the plaques of \mathcal{L}_p and which is associated to x . We will show by decreasing induction on $k \in \{0, \dots, n_x\}$ that, when x_k belongs to X_ℓ , the tangent map $\partial_{T_{x_k} \mathcal{L}_\ell} S_{f'}^{n_x-k}(i^0(f'))$ is injective.

The case $k = n_x$ follows from the fact that $i^0(f')|A'_{p+1}$ is an immersion.

Let us suppose that $\partial_{T_{x_k} \mathcal{L}_\ell} S_{f'}^{n_x-k}(i^0(f'))$ is injective. We recall that $x \mapsto n_x$ is upper semi-continuous and so for x' nearby x , $n_{x'} \leq n_x$ and so:

$$S_{f'}^{n_{x'}-k}(i^0(f'))(x') = S_{f'}^{n_x-k}(i^0(f'))(x').$$

Therefore, it follows from conclusion 2) of lemma 3.5.7, that the differential of $S_{f'}^{n_x-k+1}(i^0(f'))$ along $T_{x_{k-1}} \mathcal{L}_\ell$ is injective.

Thus, the restriction of i_p to $A_p \setminus X_p$ is an immersion. As $A_p \cap X_p$ is precompact in $L_p \cap \hat{A}_p$, by continuity of i_p and by restricting V_f , $i_p|A_p$ is a \mathcal{T} -controlled immersion.

3.5.7. Construction of a family of adapted neighborhoods \mathcal{V}^p

For $j \geq p$, by 3.5.4.2, we may suppose η' small enough such that

$$(8) \quad d(f^*(V'_j), L_j^c) > 2\eta',$$

and that the close subset $\text{cl}(\mathcal{L}_{j f^*(x)}^{\eta'})$ is a compact subset included in $\mathcal{L}_{j f^*(x)}^{2\eta'}$ which depends continuously on $x \in \text{cl}(V'_j)$, in the space of nonempty compact subsets of A endowed with the Hausdorff distance.

We can now define $\mathcal{V}^p := (V_{X_k^p})_{k=p}^N$ by

$$V_{X_j^p} := \{x \in L_j \cap A_p; \exists k \in \{p, \dots, j\} : x \in V'_{C_k} \text{ and } \text{cl}(\mathcal{L}_{k f^*(x)}^{\eta'}) \subset L_j\}.$$

We remark that, for every $j \geq p$, the subset $V_{X_j^p}$ is open. Let us show that $V_{X_j^p}$ contains $X_j^p := X_j \cap A_p$. Let x be a point of X_j^p . As $(V_{C_k}')_k$ covers A_p , there exists $k \in \{p, \dots, N\}$ such that x belongs to V_{C_k}' . Since, $V_{C_k}' \subset L_k$ intersects X_j , the integer k is not greater than j . Moreover, $f^*(x)$ belongs to X_j and the compact subset $\text{cl}(\mathcal{L}_{kf^*(x)}^{\eta'})$ is included in $\mathcal{L}_{kf^*(x)}^{2\eta'}$. Thus, by property 1.3.15, $\text{cl}(\mathcal{L}_{kf^*(x)}^{\eta'})$ is included in X_j , itself included in L_j . Therefore, x belongs to $V_{X_j^p}$. This shows that X_j^p is contained in $V_{X_j^p}$.

Finally, we notice that $V_{X_j^p}$ contains V_{C_j}' and hence C_j , for every $j \geq p$. Therefore, a part of fundamental property 4) is shown.

3.5.8. Construction of $f' \mapsto f_p^*$. — Since for every $k \geq 0$, the morphism $i^{k+1}(f')$ is equal to $S_{f'}(i^k(f'))$, by conclusion 1) of lemma 3.5.7, for $f' \in V_f$, $x \in V_{C_p}'$ and $k \geq 0$, we have

$$f' \circ i^k(f')(x) \in i^k(f')(\mathcal{L}_{pf^*(x)}^{\eta'}).$$

By taking the limit, as k approaches the infinity, we get

$$(9) \quad f' \circ i_p(f')(x) \in \text{cl}(i_p(f')(\mathcal{L}_{pf^*(x)}^{\eta'})) \subset i_p(f')(\mathcal{L}_{pf^*(x)}^{2\eta'}).$$

On A_{p+1}' , the maps i_p and i^0 are equal.

Moreover, for $j > p$, the compact subset $\text{cl}(V_{C_j}')$ is contained in A_{p+1}' which is sent into K_p , by 3.5.4.1. Thus, on a neighborhood of the compact subset $f^*(\text{cl}(V_{C_j}'))$ the map i_p and i^0 are equal. By the fact 3.5.6.1, we deduce for all $x \in V_{C_j}'$ and $f' \in V_f$:

$$(10) \quad f' \circ i_p(f')(x) \in i_p(f')(\mathcal{L}_{jf^*(x)}^{\eta'}).$$

Therefore, by restricting V_f , (9) and (10) imply that for all $j \geq p$, $x \in V_{C_j}'$, and $f' \in V_f$,

$$(11) \quad f' \circ i_p(f')(x) \in i_p(f')(\mathcal{L}_{jf^*(x)}^{\eta'}).$$

For $x \in V_{C_j}'$, let $f_p^*(x)$ be the point of $\mathcal{L}_{jf^*(x)}^{\eta'}$ such that:

$$f' \circ i_p(f')(x) = i_p(f')(f_p^*(x)).$$

This point is unique since i_p embeds the η' -plaques $\mathcal{L}_{jf^*(x)}^{\eta'}$. Also this definition does not depend on j (at the intersection points of $(V_{C_j}')_j$).

For every $j \geq p$, $x \in V_{X_j^p}$, let $p \leq k \leq j$ be such that x belongs to V_{C_k}' . As $i_p(f')$ C^r -embeds $\mathcal{L}_{kf^*(x)}^{\eta'}$, it embeds the plaques of an \mathcal{L}_j -distinguished set containing $\mathcal{L}_{kf^*(x)}^{\eta'}$.

For x' nearby x , one of these plaques, denoted by $\mathcal{L}_{f^*(x')}$ contains $f^*(x')$. Let $\mathcal{L}_{jx'}$ be a small plaque of x with compact closure sent into $\mathcal{L}_{f^*(x')}$ by f_p^* .

We notice that $f_p^*|_{\mathcal{L}_{jx'}} = (i_p(f')|_{\mathcal{L}_{jf^*(x')}})^{-1} \circ f' \circ i_p(f')|_{\mathcal{L}_{jx'}}$ is a composition of C^r -maps and so is of class C^r .

Moreover these maps depend continuously on x' around x , and so f_p^* is locally a \mathcal{L}_j - C^r morphism from $V_{X_j^p}$ into $\mathcal{L}_j|L_j \cap A_p$. In other words, f_p^* is a morphism $\mathcal{T}|A_p$ -controlled and \mathcal{V}^p is adapted to f_p^* .

As these maps depend furthermore continuously on f'' nearby f' , the following map is continuous:

$$f' \in V_f \longmapsto f_p^{f'*} \in \text{End}_{\mathcal{V}^p}(\mathcal{T}|A_p). \quad \square$$

3.6. Proof of lemma 3.5.7 and injectivity of $TS^0(f', i')$ in lemma 3.5.2

3.6.1. Proof of the injectivity of $TS^0(f', i')$ and $TS(f', i')$ in lemmas 3.5.2 and 3.5.7. — As both proof are equal, we only do the one of $TS^0(f', i')$. Let us prove, for every $j \geq p$ and $x \in X_j \cap \widehat{V}_{C_p}$, that the partial derivative $\partial_{T_x X_j}(S_{f'}^0(i'))$ is injective when $\partial_{T_{f_i^{f'*}(x)} X_j}(i')$ is injective, for all $f' \in V_f$ and $i' \in V_i$.

As we have already seen that $S^0(f', i')$ is an immersion of $\mathcal{L}_p|\widehat{V}_{C_p}$ into M , it remains to prove that, for $u \in T_x X_j \setminus T_x \mathcal{L}_p$, the vector $T(S^0(f', i'))(u)$ is nonzero, for $j > p$.

By the same argument as above, the map $f_i^{f'*}$ is $\mathcal{T}|\widehat{V}_{C_p}$ -controlled, equivalent to $f^*|\widehat{V}_{C_p}$ and C^r -close to it.

By definition of S^0 , we have for every $x' \in \widehat{V}_{C_p}$,

$$f' \circ S^0(f', i')(x') = i' \circ f_i^{f'*}(x').$$

This implies that

$$\partial_{T_x X_j}(f' \circ S^0(f', i')) = \partial_{T_x X_j}(i' \circ f_i^{f'*}).$$

Thus, it is sufficient to prove that the vector $T(i' \circ f_i^{f'*})(u)$ is nonzero. As we assume that $\partial_{T_{f_i^{f'*}(x)} X_j}(i')$ is injective, it is sufficient to prove that $Tf_i^{f'*}(u)$ is nonzero.

As $f_i^{f'*}$ is equivalent to f^* , by holonomy $Tf_i^{f'*}(u)$ does not belong to $T_{f_i^{f'*}(x)} \mathcal{L}_p \ni 0$, for every $u \in T_x X_j \setminus T_x \mathcal{L}_p$ for $x \in X_j \cap \widehat{V}_{C_p}$.

3.6.2. Definition of $S_{f'}$

For $f' \in V_f$, let

$$S_{f'} : i' \in V_i \cap \mathcal{M}_p^{f'} \longmapsto \left[x \longmapsto \begin{cases} i^0(f')(x) & \text{if } x \in A_{p+1}' \setminus V_{C_p} \\ S_{f'}^0(i')(x) & \text{if } x \in V_{C_p} \end{cases} \right],$$

where $S_{f'}^0 := S^0(f', \cdot)$ was defined in lemma 3.5.2.

By definition, the restriction to V_{Δ}' of $i^0(f')$ is equal to the one of $i_p'(f')$. Since the image by f^* of V_{Δ} is disjoint from $\text{cl}(V_{C_p} \cup V_{\Delta})$, by restricting V_f , for $f' \in V_f$ and $i' \in V_i \cap \mathcal{M}_p^{f'}$, the maps $i_p'(f')$ and $S_{f'}^0(i')$ are equal on V_{Δ}' . Thus, $i^0(f')$ and $S_{f'}^0(i')$ are equal on $A_{p+1}' \cap V_{C_p} \subset V_{\Delta}'$.

Therefore, the values of $S_{f'}$ are in $\mathcal{M}_p^{f'}$.

Let \widetilde{K}_p be the compact set $\text{cl}(V_{C_p} \cap X_p)$. Let U be a small open neighborhood of $i(\widetilde{K}_p)$ in M on which there exists a continuous extension χ of the section of the

Grassmannian of d_p -plan of $TM|_{i(\tilde{K}_p)}$ defined by⁽³⁾

$$\chi(y) = Ti(T_x \mathcal{L}_p), \quad \text{if } x \in \tilde{K}_p \text{ and } y = i(x).$$

We endow M with an adapted metric satisfying property 2.1.9, for the normally expanded lamination X_p over the compact subset \tilde{K}_p . In particular for all $x \in i(\tilde{K}_p)$, $u \in \chi(x)$, $v \in \chi(x)^\perp \setminus \{0\}$, we have

$$\lambda \cdot \|T_x f(u)\|^r < \|p \circ T_x f(v)\|,$$

with p the orthogonal projection of $T_{f(x)}M$ onto $\chi_{f(x)}^\perp$.

Also, by restricting U , there exist $\lambda > 1$ and an open cone field C over U of $i(\tilde{K}_p)$ such that the following property holds:

- For each $x \in \tilde{K}_p$, the space $Ti(T_x \mathcal{L}_p)^\perp$ is a maximal vector subspace included in $C(x)$;
- there exist $\delta > 0$ and $\lambda < 1$ satisfying for all $x \in U$ and $u \in cl(C(x)) \setminus \{0\}$ with norm less than δ ,

$$v := \exp_{f(x)}^{-1} \circ f \circ \exp(u) \in C(f(x)) \quad \text{and} \quad \lambda \|v\| > \|u\|,$$

with \exp be the exponential map associated to the adapted metric.

3.6.3. The C^0 -contraction. — Let $U^* \subset V_{C_p} \setminus V_\Delta$ be a neighborhood of $X_p \cap \hat{A}_p$, whose closure is sent by i into $f^{-1}(U) \cap U$. For V_i and V_f small enough, any $f' \in V_f$ and $i' \in V_i$ satisfy

$$S^0(f', i')(U^*) \subset U \cap f'^{-1}(U).$$

Consequently, for $\eta' > 0$, $\delta > 0$ and then V_i and V_f small enough, for all $f' \in V_f$, $(i', i'') \in (V_i \cup S_{f'}^0(V_i))^2$, and $x \in U^*$, we have:

- for every $u \in C_{i'(x)}$ with norm less than δ , the vector $\exp_{f'(x)}^{-1} \circ f' \circ \exp(u)$ belongs to $C_{f'(x)}$ and has norm greater than $\|u\|/\lambda$;
- the following number is equal to 0 if and only if $i'(x)$ is equal to $i''(x)$:

$$d_x(i', i'') := \sup_{\substack{u \in cl(C_{i'(x)}) \\ \|u\| < \delta}} \{ \|u\|; \exp(u) \in i''(\mathcal{L}_{p_x}^\delta) \};$$

- the number $d_x(i', i'')$ is also equal to

$$\sup_{\substack{u \in cl(C_{i'(x)}) \\ \|u\| < \|Tf|U\| \cdot \delta}} \{ \|u\|; \exp(u) \in i''(\mathcal{L}_{p_x}^{\delta+2\eta'}) \}.$$

By definition of S^0 and f'^* , the map f' sends $S_{f'}^0(i')(x)$ to $i' \circ f_{i'}^*(x)$. For every $u \in C_{S^0(f', i')(x)}$ with norm less than δ , if $\exp(u)$ belongs to $S_{f'}^0(i'')(\mathcal{L}_{p_x}^\delta)$, then it is sent by f' into $i''(\mathcal{L}_{p f_{i'}^*(x)}^{\delta+\eta}) \subset i''(\mathcal{L}_{p f_{i'}^*(x)}^{\delta+2\eta})$. Thus, we have

$$(12) \quad d_x(S_{f'}^0(i'), S_{f'}^0(i'')) \leq \lambda d_{f_{i'}^*(x)}(i', i'').$$

3. It follows from property 2.1.6 that such a section is well defined.

If d denote the Riemannian distance on M , we notice that d_x and

$$d_x^\infty : (i', i'') \mapsto d(i'(x), i''(x))$$

are uniformly equivalent on U^* . Therefore, the map

$$d_0 : (i', i'') \mapsto \sup_{x \in U^*} (d_x(i', i'') + d_x(i'', i'))$$

defines a semi-distance on $V_i \cap S_{f'}^0(V_i)$, for every $f' \in V_f$. Moreover, this semi-distance is equivalent to the semi-distance

$$d_\infty(i', i'') = \sup_{x \in U^*} d_x^\infty(i', i'').$$

In fact, the equivalence is uniform for $f' \in V_f$, since d_x and d_x^∞ do not depend on $f' \in V_f$.

As $S_f(i)$ is equal to i , by (12), for any $i' \in V_i$, we have

$$d_0(i, S_f^0(i)) = d_0(S_f^0(i), S_f^0(i')) \leq \lambda d_0(i, i').$$

Thus, for any $\epsilon \in]0, \delta[$, the intersection of the ϵ -ball centered at i with $S_f^N(\mathcal{M}_p^{f'} \cap V_i)$ is sent by S_f into the ϵ/λ -ball centered at i , with respect to the d_0 -distance.

By continuity of $f' \mapsto S_{f'}$, by restricting V_f , for every $f' \in V_f$, the intersection of V_i with the ϵ -ball centered at i has the closure of its image by $S_{f'}^0$, included in the ϵ -ball centered at i .

Moreover, by equation (12), the map $S_{f'}^0$ is λ -contracting on V_i , for any $f' \in V_f$, with respect to the semi-distance d_0 .

3.6.4. The 1-jet space. — Contrarily to what happened in the C^0 -topology, the map S_f is usually not contracting for the C^1 -topology. However, we are going to show that the backward action of Tf on the Grassmannian of d_p -plans of TM is contracting, at the neighborhood of the distribution induced by TX_p .

The bundle of linear maps from χ into χ^\perp , denoted by P^1 , is canonically homeomorphic (via the graph map) to an open neighborhood of χ in the Grassmannian of d_p -plans of $TM|U$. In this identification the zero section is sent to χ .

We endow P^1 with the norm subordinate to the aforementioned adapted Riemannian metric of M .

By normal expansion, for U small enough and f' close enough to f , for every $x \in U$ sent by f' to a certain $y \in U$, for any $\ell \in P_y^1$ small enough, the preimage by $T_x f'$ of the graph of ℓ is the graph of a small $\ell' \in P_x^1$.

Let us show the following lemma:

LEMMA 3.6.1. — *For all $\epsilon > 0$, then U and then V_f small enough, for all $f' \in V_f$, $x \in U \cap f'^{-1}(U)$ and $\ell \in P_{f'(x)}^1$ with norm not greater than $\epsilon > 0$, then the norm of $\phi_{f'x}(\ell) := \ell' \in P_x^1$ is less than ϵ . Moreover, the map $\phi_{f'x}$ is λ -contracting.*

Proof. — Let π_v and π_h be the orthogonal projections of $TM|U$ onto respectively χ^\perp and χ . Let $Tf'_h := \pi_h \circ Tf'$ and $Tf'_v := \pi_v \circ Tf'$ which are defined on $f'^{-1}(U)$. For

any vector $e' \in \chi(x)$, the point $(e', \ell'(e'))$ is sent by $T_x f'$ to

$$(Tf'_h(e', \ell'(e')), Tf'_v(e', \ell'(e'))).$$

Let $e := Tf'_h(e', \ell'(e'))$. By definition of ℓ' , the point $(e', \ell'(e'))$ is sent by $T_x f'$ to $(e, \ell(e))$.

Therefore, we have $\ell(e) = Tf'_v(e', \ell'(e'))$ and $\ell(e) = \ell \circ Tf'_h(e', \ell'(e'))$.

$$\begin{aligned} \implies Tf'_v(e', \ell'(e')) &= \ell \circ Tf'_h(e', \ell'(e')) \\ \implies (Tf'_v - \ell \circ Tf'_h)(\ell'(e')) &= (\ell \circ Tf'_h - Tf'_v)(e'). \end{aligned}$$

By normal expansion, for ϵ , U and V_f small enough, the map $(Tf'_v - \ell \circ Tf'_h)|_{\chi^\perp}$ is bijective. Consequently:

$$\ell'(e') = (Tf'_v - \ell \circ Tf'_h)|_{\chi^\perp}^{-1}(\ell \circ Tf'_h - Tf'_v)(e').$$

Hence, the expression of $\ell' = \phi_{f',x}(\ell)$ depends algebraically on ℓ , and the coefficients of this algebraic expression depend continuously on f' and x via some trivializations.

When f' is equal to f and x belongs to $i(\tilde{K}_p)$, the map

$$\phi_{fx} : \ell' \mapsto (Tf_v - \ell \circ Tf_h)|_{\chi^\perp}^{-1}(\ell \circ Tf_h)$$

is λ -contracting for ℓ small, by normal expansion.

Thus, for U small enough, for all $x \in U \cap f^{-1}(U)$ and $\ell \in B_{P_{f',x}}(0, \epsilon)$, the partial derivative $\partial_{\ell'} \phi_{fx}$ has a norm less than λ . Therefore, by restricting a slice U , for V_f small enough, the partial derivative $\partial_{\ell'} \phi_{f',x}$ has a norm less than λ and hence $\phi_{f',x}$ is a λ -contraction on $\text{cl}(B_{P_y}(0, \epsilon))$, with $y = f'(x)$.

As, for $x \in i(\tilde{K}_p)$, the map ϕ_{fx} vanishes at 0, for U and V_f small enough, the norm $\phi_{f',x}(0)$ is less than

$$(1 - \lambda) \cdot \epsilon.$$

Consequently, by λ -contraction, the closed ϵ -ball centered at the 0-section is sent by $\phi_{f'}$ into the ϵ -ball centered at 0, for all $x \in f'^{-1}(U) \cap U$ and $f' \in V_f$. \square

3.6.5. Proof of the lemma 3.5.7 when $r = 1$. — Let us begin by proving the existence of a neighborhood $V_{f,i}$ sent by S into itself.

Following the arguments of sections 3.5.6, for V_i and V_f small enough, there exists $N > 0$ such that the subset $V_{C_p} \setminus U^*$ is included in U_N ⁽⁴⁾. In particular, the restriction of $S_{f'}^N(i')$ to U^{*c} does not depend on i' but only on f' , for (f', i') in the domain of S^N .

For $\epsilon > 0$ and then V_f small enough, the set

$$\begin{aligned} V^{f,\epsilon} := \{ i' \in \mathcal{M}_p^f; i' = S_{f'}^N(i^0(f')) \text{ on } U^{*c}; d_0(i, i') < \epsilon, \\ \text{and } Ti(T_x \mathcal{L}_p | U^*) \in B_{P_x^1}(0, \epsilon), \forall x \in U^* \} \end{aligned}$$

4. U_N is the set of points $x \in V_{C_p}$ such that there is no any η' -chain of V_{C_p} which respects \mathcal{L}_p , which start at x , and with length N .

is nonempty and included in V_i . Therefore, by the two last steps and by the equality of S and S^0 on $U^* \subset V_{C_p} \setminus V_\Delta$, the map $S_{f'}$ sends $V^{f'\epsilon}$ into itself. Thus, the following neighborhood of $(f, i) \in \mathcal{M}$ is sent by S into itself:

$$V_{f,i} := \bigcup_{\substack{f' \in V_f \\ 0 \leq k \leq N}} \{f'\} \times S_{f'}^{-k}(V^{f'\epsilon}).$$

We remark that, for any $f' \in V_f$, the restriction of d_0 to $V^{f'\epsilon}$ is a distance, which is equivalent to the distance defining the strong C^0 -topology, for which $S_{f'}$ is λ -contracting. By restricting V_i and V_f , and hence $V_{f,i}$, we may suppose that the set

$$F := \bigcup_{(f',i') \in V_{f,i}} i'(U^*) \cup f' \circ i'(U^*)$$

has its closure included in the interior of U .

Let $r \in C^0(U, [0, 1])$ be equal to 1 on F and with compact support in U . Let

$$\begin{aligned} r\phi : V_f \times \text{cl}(B_{\Gamma^0 P^1}(0, \epsilon)) &\longrightarrow \text{cl}(B_{\Gamma^0 P^1}(0, \epsilon)), \\ (f', \sigma) &\longmapsto [r \cdot \phi_{f'} : x \mapsto r(x) \cdot \phi_{f',x}(\sigma \circ f'(x))], \end{aligned}$$

where $\Gamma^0 P^1$ is the set of the continuous sections of the bundle $P^1 \rightarrow U$.

For every $f' \in V_f$, the map $r\phi_{f'}$ is still λ -contracting and hence has a fixed continuous section $\sigma_{f'}$, which depends continuously on $f' \in V_f$. Thus, for every $f' \in V_f$, there exists a neighborhood $V_{f'}$ of $f' \in V_f$, such that,

$$\|\sigma_{f'} - \sigma_{f''}\|_\infty < \delta, \quad \forall f'' \in V_{f'}.$$

By uniform continuity of $\sigma_{f'}$, there exists $e > 0$ such that

$$\forall (x, y) \in U^2, \text{ if } d(x, y) < e \text{ then } d(\sigma_{f'}(x), \sigma_{f'}(y)) < \delta.$$

Let $N' > N$ be such that $\lambda^{N'-N}\epsilon$ is less than δ and e . Thus, for every $f'' \in V_{f'}$, the diameter of $r\phi_{f''}^{N'}(B(0, \epsilon))$ is less than δ and the C^0 -diameter of $\{i' \in V_i : (f'', i') \in S^{N'}(V_{f,i})\}$ is less than e .

For $N'' > N'$ large enough, for all $f'' \in V_{f'}$ and $((f'', i''), (f'', i')) \in S^{N''}(V_{f,i})^2$, we have for every $x \in V_{C_p}$:

- either $f''^k(i''(x))$ and $f''^k(i'(x))$ belong to F , for all $x \in \{0, \dots, N'\}$, hence $Ti''(T_x \mathcal{L}_p)$ and $Ti'(T_x \mathcal{L}_p)$ belong to $r\phi_{f''}^{N'}(B(0, \epsilon))$;
- either $i''(x)$ is equal to $i'(x)$ and $Ti''(T_x \mathcal{L}_p)$ and $Ti'(T_x \mathcal{L}_p)$ are equal.

In the first case, $d(Ti''(T_x \mathcal{L}_p), Ti'(T_x \mathcal{L}_p))$ is not greater than

$$\begin{aligned} &d(Ti''(T_x \mathcal{L}_p), \sigma_{f''}(i''(x))) \\ &\quad + d(\sigma_{f''}(i''(x)), \sigma_{f'}(i''(x))) + d(\sigma_{f'}(i''(x)), \sigma_{f'}(i'(x))) \\ &\quad + d(\sigma_{f'}(i'(x)), \sigma_{f''}(i'(x))) + d(\sigma_{f''}(i'(x)), Ti''(T_x \mathcal{L}_p)) \\ &\implies d(Ti''(T_x \mathcal{L}_p), Ti'(T_x \mathcal{L}_p)) \leq 5\delta. \end{aligned}$$

The last inequality concludes the proof of conclusion 3, when $r = 1$.

3.6.6. General case: $r \geq 1$. — As we deal with the C^r -topology, we shall generalize the Grassmannian concept as follows:

For $x \in U$, let G_x^r be the set of the C^r - d_p -submanifolds of M , which contain x , quotiented by the following r -tangent equivalence relation: *two such submanifolds N and N' are equivalent if there exists a chart (U, ϕ) of a neighborhood of $x \in M$, which sends $N \cap U$ onto $\mathbb{R}^{d_p} \times \{0\}$ and sends $N' \cap U$ onto the graph of a map from \mathbb{R}^{d_p} into \mathbb{R}^{n-d_p} , whose r -first derivatives vanish at $\phi(x)$.*

Notice that for $r = 1$, this space is the Grassmannian of d_p -planes of $T_x M$.

As we are interested in the submanifolds “close” to the embedding of the small \mathcal{L}_p -plaques by i , we restrict this study to the manifolds whose tangent space at x complements $\chi(x)^\perp$.

The preimage of such submanifolds by the map \exp_x is a graph of some C^r -maps $\bar{\ell}$ from $\chi(x)$ to $\chi(x)^\perp$.

Moreover, their r -tangent equivalence class can be identified to the Taylor polynomial of $\bar{\ell}$ at 0:

$$\bar{\ell}(u) = T_0 \bar{\ell}(u) + \frac{1}{2} T_0^2 \bar{\ell}(u^2) + \dots + \frac{1}{r!} T_0^r \bar{\ell}(u^r) + o(\|u\|^r)$$

where u belongs to $\chi(x)$ and the k -th derivative $T_0^k \bar{\ell}$ belongs to the space $I_{\text{sym}}^k(\chi(x), \chi(x)^\perp)$ of k -linear symmetric space from $\chi(x)^k$ to $\chi(x)^\perp$. We notice that we abused of notation by writing u^k instead of (u, \dots, u) .

The map $\ell(u) := \sum_{k=1}^n \frac{1}{k} T_0^k \bar{\ell}(u)$ is an element of the vector space

$$P_x^r := \bigoplus_{k=1}^r L_{\text{sym}}^j(\chi(x), \chi(x)^\perp).$$

Conversely, any vector $\ell \in P_x^r$ written in the form

$$\ell : u \in \chi(x) \mapsto \sum_{k=1}^r \ell_k(u^k)$$

is the class of the following C^r - d_p -submanifold:

$$\exp \left(\left\{ (u + \ell(u)); u \in \chi(x) \text{ and } \|u\| < \frac{1}{2} r_i(x) \right\} \right),$$

where r_i is the injectivity radius of \exp .

The linear map ℓ_1 from $\chi(x)$ to $\chi(x)^\perp$ will be called the *linear part* of ℓ . We notice that ℓ_1 belongs to P_x^1 .

We denote by P^r the vector bundle over U , whose fiber at x is P_x^r .

By normal expansion, for U small enough and f' close enough to f , for any point $x \in U$ sent by f' into some $y \in U$, any $\ell \in P_y^r$ whose linear part is small enough, the preimage by f' of a representative of ℓ is a representative of vector $\phi_{f',x}(\ell) \in P_x^r$, which depends only on ℓ .

There exists a canonical norm on the bundle P^r over U , and hence on the continuous section $\Gamma^0 P^r$. By the previous section, it is sufficient to prove the following lemma:

LEMMA 3.6.2. — *The map:*

$$\begin{aligned} r\phi : V_f \times \text{cl}(B_{\Gamma^0 P^r}(0, \epsilon)) &\longrightarrow \text{cl}(B_{\Gamma^0 P^r}(0, \epsilon)), \\ (f', \sigma) &\longmapsto [r \cdot \phi_{f'} : x \mapsto \phi(x) \cdot \phi_{f'_x}(\sigma \circ f'(x))] \end{aligned}$$

has an iterate which is contracting.

We recall that r is a continuous function equal to 1 on F and with support in U .

Proof. — Let us show the contraction of $\phi_{f'_x}$ for some equivalent norm. Let $\ell' := \phi_{f'}(\ell)$. Let $J_x^r f'$ be the r -jet map of f' at x (see [23]).

We recall that the r -jet $J_x^r f'$ of f at x is a vector of

$$\prod_{j=1}^r L_{\text{Sym}}^j(T_x M, T_{f'(x)} M)$$

such that, if we denote by f'_j its component in $L_{\text{Sym}}^j(T_x M, T_{f'(x)} M)$, we have

$$\exp_{f'(x)}^{-1} \circ f' \circ \exp_x(u) = \sum_{j=1}^r f_j(u^j) + o(\|u\|^r), \text{ for } u \in \chi(x).$$

By definition of $\ell' := \phi_{f'_x}(\ell)$, for any $u' \in \chi(x)$, there exists $u \in \chi(f'(x))$ such that

$$(13) \quad J_x^r f'(u' + \ell'(u')) = (u + \ell(u)) + o(\|u\|^r).$$

We recall that π_v and π_h denote the orthogonal projection of $TM|U$ onto respectively χ^\perp and χ . By (13), we have

$$\begin{aligned} u &:= \pi_h \circ J_x^r f'(u' + \ell'(u')) + o(\|u'\|^r), \\ \ell(u) &= \pi_v \circ J_x^r f'(u' + \ell'(u')) + o(\|u'\|^r). \end{aligned}$$

Thus, we have

$$(14) \quad \ell \circ \pi_h \circ J_x^r f'(u' + \ell'(u')) = \pi_v \circ J_x^r f'(u' + \ell'(u')) + o(\|u'\|^r).$$

We have

$$(15) \quad J^r f'_x(u' + \ell'(u')) = \sum_{I \in R} f'_{|I|} \left[\prod_{k \in I} \ell'_k(u'^k) \right] + o(\|u'\|^r),$$

where R is the set $\bigcup_{k=1}^r \{0, \dots, r\}^k$, $\ell'_0(u'^0)$ is equal to u' , and for $I \in R$, $|I|$ is the length of I .

Let f_{kv} and f_{kh} be the linear maps $\pi_v \circ f_k$ and $\pi_h \circ f_k$ respectively, for every $k \in \{0, \dots, r\}$. It follows from equations (14) and (15) that

$$(16) \quad \ell \left(\sum_{I \in R} f'_{|I|h} \left[\prod_{k \in I} \ell'_k(u'^k) \right] \right) = \sum_{I \in R} f'_{|I|v} \left[\prod_{k \in I} \ell'_k(u'^k) \right] + o(\|u'\|^r).$$

On the one hand, we have

$$(17) \quad \sum_{I \in R} f'_{|I|v} \left[\prod_{k \in I} \ell'_k(u'^k) \right] = \sum_{m=1}^r \left(\sum_{I \in R, \Sigma I=m} f'_{|I|v} \left[\prod_{k \in I} \ell'_k(u'^k) \right] \right) + o(\|u'\|^r)$$

with, for every $I \in R$, ΣI equal to $\sum_{j \in I} j$ plus the number of times that 0 belongs to I . On the other, we have

$$\ell\left(\sum_{I \in R} f'_{|I|h} \left[\prod_{k \in I} \ell'_k(u^{k'}) \right]\right) = \sum_{a=1}^r \ell_a \left(\sum_{I \in R} f'_{|I|h} \left[\prod_{k \in I} \ell'_k(u^{k'}) \right] \right)^a$$

as

$$\left(\sum_{I \in R} f'_{|I|h} \left[\prod_{k \in I} \ell'_k(u^{k'}) \right] \right)^a = \sum_{(I_\alpha)_{\alpha \in R^a}} \prod_{\alpha} f'_{|I_\alpha|h} \left[\prod_{k \in I_\alpha} \ell'_k(u^{k'}) \right].$$

Thus, the polynomial map $\ell\left(\sum_{I \in R} f'_{|I|h} \left[\prod_{k \in I} \ell'_k(u^{k'}) \right]\right)$ is equal to

$$(18) \quad \sum_{m=1}^r \sum_{\substack{(I_\alpha)_{\alpha \in A} \in R^* \\ \sum_{\alpha} \Sigma I_\alpha = m}} \ell_{|A|} \left(\prod_{\alpha \in A} f'_{|I_\alpha|h} \left[\prod_{k \in I_\alpha} \ell'_k(u^{k'}) \right] \right)$$

with $R^* := \bigcup_{a=1}^r R^a$. By identification, it follows from equations (16), (17), and (18) that for every $m \in \{1, \dots, r\}$

$$\underbrace{\sum_{\substack{(I_\alpha)_{\alpha \in A} \in R^* \\ \sum_{\alpha} \Sigma I_\alpha = m}} \ell_{|A|} \left(\prod_{\alpha \in A} f'_{|I_\alpha|h} \left[\prod_{k \in I_\alpha} \ell'_k(u^{k'}) \right] \right)}_{\substack{\ell'_m \text{ only occurs for } (I_\alpha)_{\alpha} = ((m)) \\ \ell'_m \text{ only for } (I_\alpha)_{\alpha} \in \{\{0\}, \{1\}\}^m}} = \underbrace{\sum_{\substack{I \in R \\ \Sigma I = m}} f'_{|I|v} \left[\prod_{k \in I} \ell'_k(u^{k'}) \right]}_{\text{here } \ell'_m \text{ only occurs for } I = (m)}.$$

Thus, there exists an algebraic function ϕ such that $f'_{1v} \circ \ell'_m(u^m)$ is equal to

$$\sum_{(i_\alpha)_{\alpha=1}^m \in \{0,1\}^m} \ell_m \left(\prod_{\alpha=1}^m f'_{1h} \circ \ell'_{i_\alpha}(u^{i_\alpha}) \right) + \ell_1 \circ f'_{1h} \circ \ell'_m(u^m) + \phi((\ell_i)_{i < m}, (\ell'_i)_{i < m}, (f_i)_{i=1}^r).$$

Since the linear part ℓ_1 of ℓ is small, we have

$$\ell'_m = (f'_{1v} - \ell_1 \circ f'_{1h})|_{\chi^\perp}^{-1} \left[\phi((\ell_i)_{i < m}, (\ell'_i)_{i < m}, (f_i)_{i=1}^r) + \sum_{I \in \{0,1\}^m} \ell_m \circ \prod_{k \in I} f'_{1h} \circ \ell_k \right].$$

For $x \in i(\tilde{K}_p)$ and $f' = f$, we have $f'_{1h}|_{\chi^\perp} = 0$. Thus,

$$\sum_{I \in \{0,1\}^m} \ell_m \prod_{k \in I} f'_{1h} \circ \ell_k = \ell_m \circ (f_{1h})^m.$$

It follows from the r -normal expansion that the map

$$C : \ell_m \mapsto (f'_{1v} - \ell_1 \circ f'_{1h})|_{\chi^\perp}^{-1} \circ \ell_m \circ (f_{1h})^m$$

is λ -contracting, when ℓ_1 is small.

By induction, the map ℓ'_s is an algebraic function of only $(\ell_k)_{k \leq s}$ and $(f'_k)_{j \leq s}$, for $s \leq m$. Thus,

$$\ell'_m = C_m(\ell_m) + \phi((\ell_i)_{i < m}, (f_i)_i).$$

This implies that for an equivalent norm on P^r , the map ϕ_{f_x} is contracting, for U small enough and then f' C^r -close to f . Thus $r\phi$ is contracting for an equivalent norm. This concludes the lemma proof. \square

3.6.7. Proof of gluing lemma 3.5.5. — For every $j > p$, let us admit the following lemma:

LEMMA 3.6.3. — *There exist an open neighborhood G_j of the graph of $i|_{\text{cl}(V_{C_j})}$ and a continuous map*

$$\phi_j : V_{f'} \longrightarrow \text{Mor}^r((\mathcal{T} \times M)|G_j \times [0, 1], M), \quad f' \longmapsto [(x, y, t) \mapsto \phi_{jf'}(x, t)(y)]$$

such that for every $f' \in V_f$ and $x \in \text{cl}(V_{C_j})$:

- (a) for every $t \geq 1/N$, $\phi_{jf'}(x, t)$ is a retraction of $G_{jx} := G_j \cap (\{x\} \times M)$ onto $i_{p+1}(f')(\mathcal{L}_{jx}^{\eta'})$;
- (b) the map $\phi_{jf'}(x, 0)$ is equal to the identity of an open set of M ;
- (c) the restriction of $\phi_{jf'}(x, t)$ to $i_{p+1}(f')(\mathcal{L}_{jx}^{\eta'})$ is the identity for every $t \in [0, 1]$.

Let $(r_j)_{j>p}$ be a partition of the unity subordinate to the covering

$$\left(V_{C_j} \setminus \bigcup_{p < k < j} \text{cl}(V_{C_k}') \right)_j$$

of A'_{p+1} . By restricting V_f , we can define for all (x, y) in a neighborhood G of the graph of $i|_{V_\Delta}$, $t \in [0, 1]$, and $f' \in V_f$, the point

$$\gamma_{f'}(x, y, t) := \phi_{Nf'}(x, r_N(x)) \circ \cdots \circ \phi_{(p+1)f'}(x, r_1(x)) \circ \psi_{f'}(x, y, t),$$

with $\psi_{f'}(x, y, t) := \text{Exp}(t \cdot \text{Exp}_{i_{p+1}(f')(x)}^{-1}(y))$ and $\phi_{jf'}(x, 0)(y) = y$, for all $(x, y) \in G$, $t \in [0, 1]$, and $f' \in V_f$. We notice that, by (b), $\gamma_{f'}$ is a $(\mathcal{T} \times M)|G \times [0, 1]$ -controlled C^r -morphism which depends continuously on $f' \in V_f$.

Let us check properties 1), 2) and 3) of lemma 3.5.5.

1) The point $\psi_{f'}(x, y, 0)$ is equal to $i_{p+1}(f')(x)$. Since $i_{p+1}(f')(x)$ belongs obviously to $i_{p+1}(f')(\mathcal{L}_{jx}^{\eta'})$, for each j such that $V_{C_j} \ni x$, by (c), we get 1).

2) Let $(x, y) \in G$ be such that x belongs to V_{C_j}' , for some $j \in \{p+1, \dots, N\}$. Therefore $r_k(x)$ is equal to zero, for every $k > j$. Thus, the sum $\sum_{p < k \leq j} r_k(x)$ is equal to 1. Consequently, there exists $k \in \{p+1, \dots, j\}$ such that $r_k(x)$ is greater than $1/N$. Therefore, by (a), the point

$$z := \phi_{kf'}(x, r_k(x)) \circ \cdots \circ \phi_{1f'}(x, r_1(x)) \circ \psi_{f'}(x, y, t)$$

belongs to $i_{p+1}(f')(\mathcal{L}_{kx}^{\eta'})$.

By coherence of the tubular neighborhoods, z belongs to $i_{p+1}(f')(\mathcal{L}_{jx}^{\eta'})$, for all $m > k$ such that x belongs to V_{C_m} .

By (c), the point $\phi_{mf'}(x, r_m(x))(z)$ is z . Consequently, $\gamma_{f'}(x, y, t)$ is equal to z which belongs to $i_{p+1}(f')(\mathcal{L}_{jx}^{\eta'})$.

3) This last property is obvious, by definition of ψ and (c).

It remains to prove lemma 3.6.3.

Proof of lemma 3.6.3. — In the beginning of section 3.5, we defined a tubular neighborhood $(\mathcal{F}_{jx})_{x \in L_j}$ of \mathcal{L}_j . Remember that \widehat{V}_{C_j} is a neighborhood of $\text{cl}(V_{C_j})$. For every $x \in \widehat{V}_{C_j}$, any $y \in M$ close to $i(x)$ belongs to the foliation $(\mathcal{F}_{jx'})_{x' \in \mathcal{L}_{jx}^{\eta'}}$. Also for f' close to f , the submanifold $i_{p+1}(f')(\mathcal{L}_{jx}^{\eta'})$ is a transverse section to this foliation and the leaf of y intersects $i_{p+1}(f')(\mathcal{L}_{jx}^{\eta'})$ at a unique point $\pi_j(f')(y)$.

This defines a map $\pi_j(f') : G_j \rightarrow M$ from a neighborhood G_j of the graph of $i|_{\widehat{V}_{C_j}}$. By smoothness of the foliation $(\mathcal{F}_{jx'})_{x' \in \mathcal{L}_{jx}^{\eta'}}$, the map $\pi_j(f')|_{G_j \cap \mathcal{L}_{jx}^{\eta'} \times M}$ is of class C^r . As this foliation and manifold depend continuously on x , the map $\pi_j(f')$ is a C^r -morphism from $\mathcal{L}_j \times M|_{G_j}$ into M .

As the transverse sections depend continuously on f' , the map $f' \mapsto \pi_j(f') \in \text{Mor}(\mathcal{L}_j \times M|_{G_j}, M)$ is continuous.

The well definition and the continuity of $f' \mapsto \pi_j(f') \in \text{Mor}(\mathcal{T} \times M|_{G_j}, M)$ is proved like in 3.5.6.

Let ρ be a bump function equal to 0 on $[1/N, \infty)$ and to 1 on \mathbb{R}^- .

Put $\phi_{j f'}(x, t)(y) = \exp(\rho(t) \exp_{\pi_j(f')(x, y)}^{-1}(y))$, with \exp the exponential function associated to the Riemannian metric of M . We note that $\phi_{j f'}(x, t)$ satisfies the requested properties. □

APPENDIX A

ANALYSIS ON LAMINATIONS AND ON TRELLIS

A.1. Partition of unity

A.1.1. Partition of unity on a lamination

PROPERTY A.1.1

- 1) Let L be a second countable locally compact metric space. There exists an increasing sequence of compact subsets $(K_n)_{n \geq 0}$ whose union is equal to L and such that, for every $n \geq 0$, the compact subset K_n is included in the interior of K_{n+1} .
- 2) Let (L, \mathcal{L}) be a lamination. There exists a locally finite open covering $(V_i)_i$ of L , such that each open subset V_i is precompact in a distinguish open subset.

Proof. — 1) By local compactness of L , for every $x \in L$, we can define the supremum r_x of $r \in]0, 1[$ such that the ball $B(x, r)$ is precompact. As L is second countable, there exists a family $(x_i)_{i \in \mathbb{N}}$ dense in L . Thus, for each $x \in L$, there exists a point x_i at a distance less than $\frac{1}{8}r_x$ from x . Therefore, the ball $B(x_i, \frac{1}{4}r_x)$ is included in $B(x, \frac{1}{2}r_x)$. As the last ball is precompact, the ball $B(x_i, \frac{1}{4}r_x)$ is also precompact; this implies that $r_{x_i} \geq \frac{1}{4}r_x$. We remark that x belongs to the ball $B(x_i, \frac{1}{8}r_x)$ which is included in $B(x_i, \frac{1}{2}r_{x_i})$. Thus, the family of precompact balls $(B(x_i, \frac{1}{2}r_{x_i}))_i$ is a covering of L .

Let $K_n := \bigcup_{0 \leq i \leq n} \text{cl}(B(x_i, \frac{1}{2}r_{x_i}))$. The family of compact subsets $(K_n)_n$ is increasing and its union is equal to L . For every $n \geq 0$, the family $(K_n \setminus \text{int}(K_{n+p}))_{p \geq 0}$ is a decreasing sequence of compact subsets whose intersection is empty:

$$\bigcap_{p \geq 0} K_n \setminus \text{int}(K_{n+p}) = K_n \setminus \bigcup_{p \geq 0} \text{int}(K_{n+p}) \subset K_n \setminus \bigcup_{i \geq 0} B(x_i, \frac{1}{2}r_{x_i}) = \emptyset.$$

Consequently, there exists $p \geq 0$ such that $K_n \setminus \text{int}(K_{n+p})$ is empty; in other words K_n is included in the interior of K_{n+p} . Thus, by considering a subsequence of $(K_n)_n$, we may suppose that K_n is included in the interior of K_{n+1} .

2) Let $(K_n)_n$ be the sequence of compact subsets given by 1). We denote by C_n the compact subset $K_n \setminus \text{int}(K_{n-1})$ (with $K_{-1} := \emptyset$). For each $n \geq 0$ and $x \in C_n$,

there exists $r_x^n > 0$ such that $B(x, r_x^n)$ is disjoint from K_{n-2} , included in K_{n+1} and with (compact) closure included in a distinguish open subset of \mathcal{L} . By compactness of C_n , there exists a finite family $(x_i)_{i \in I_n}$ of points of C_n , such that $(B(x_i, r_{x_i}^n))_n$ covers C_n . Thus, the family $(V_i)_i := (B(x_i, r_{x_i}^n))_{n \geq 0, i \in I_n}$ is a locally finite covering of L such that each open subset V_i is included in a distinguish open subset. \square

PROPOSITION A.1.2. — *Let (L, \mathcal{L}) be a C^r -lamination, for some $r \geq 1$.*

- 1) *For all $\eta > 0$ and $x \in L$, there exists a nonnegative function $\rho \in \text{Mor}^r(\mathcal{L}, \mathbb{R})$ whose support is included in $B(x, \eta)$ and such that $\rho(x)$ is positive.*
- 2) *Given a locally finite open covering $(U_i)_{i \in I}$ of L , there exists $(\rho_i)_i \in \text{Mor}^r(\mathcal{L}, \mathbb{R}^+)^I$ such that $\sum_i \rho_i = 1$ and such that the support of ρ_i is included in U_i . We will say that $(\rho_i)_i$ is a partition of unity subordinate to $(U_i)_i$.*
- 3) *The subset of morphisms from the lamination (L, \mathcal{L}) to \mathbb{R} is dense in the space of the continuous functions on L endowed with the C^0 -strong topology.*

Proof. — 1) Let $(U, \phi) \in \mathcal{L}$ be a chart of a neighborhood of x , which can be written in the form

$$\phi : U \longrightarrow V \times T$$

where V is a open subset of \mathbb{R}^d and T a metric space. We denote by ϕ_1 and ϕ_2 the coordinates of ϕ . We can suppose that $\phi_1(x) = 0$. Let $\rho_1 \in C^\infty(V, \mathbb{R}^+)$ be a nonnegative function with compact support, such that $\rho_1(0)$ is nonzero and the preimage by ϕ of $\text{supp}(\rho_1) \times \{\phi_2(x)\}$ is included into the ball $B(x, \eta)$.

By compactness, there exists a neighborhood τ of $\phi_2(x)$ in T such that the preimage by ϕ of $\text{supp}(\rho_1) \times \tau$ is included in the ball $B(x, \eta)$. Let ρ_2 be a nonnegative continuous function on T , with support in τ and nonzero at $\phi_2(x)$. We define then

$$\rho : y \longmapsto \begin{cases} \rho_1 \circ \phi_1(y) \cdot \rho_2 \circ \phi_2(y) & \text{if } y \in U, \\ 0 & \text{otherwise.} \end{cases}$$

We note that the function ρ satisfies the requested properties.

2) Let us begin by admitting this statement when I is finite. Let $(K_n)_n$ be a sequence of compact subsets of L , given by property A.1.1.1. Let $K_{-1} := K_{-2} := \emptyset$. Thus, for each $n \geq 0$, there exists a function $r_n \in \text{Mor}^r(\mathcal{L}, [0, 1])$ equal to 1 on $K_n \setminus K_{n-1}$ and 0 on $K_{n-2} \cup K_{n+1}^c$. Let $(U_i)_{i \in I_n}$ be a finite subcovering of the covering $(U_i)_{i \in I}$ of $K_{n+1} \setminus K_{n-2}$. Thus, there exists $(\rho_i^n)_{i \in I_n}$ a partition of unity subordinate to the open covering $(U_i)_{i \in I_n}$ of $\bigcup_{i \in I_n} U_i$. Let

$$\rho_i := \frac{\sum_{\{n: I_n \ni i\}} r_n \cdot \rho_i^n}{\sum_n r_n} \in \text{Mor}^r(\mathcal{L}, \mathbb{R}^+),$$

whose support is in U_i and satisfies

$$\sum_i \rho_i = \frac{\sum_n r_n \sum_{i \in I_n} \rho_i^n}{\sum_n r_n} = \frac{\sum_n r_n}{\sum_n r_n} = 1.$$

Consequently $(\rho_i)_i$ is a partition of unity subordinate to $(U_i)_i$. It is now sufficient to prove the existence of a partition of unity when I is finite.

Let us show, by induction on the cardinality of I , that it is sufficient to prove this proposition when the cardinality of I is equal to 2. If the cardinality of I is $k+1 > 2$, by the induction hypothesis, there exists a partition of unity (r_0, r_{k+1}) subordinate to $(\bigcup_{j \leq k} U_j, U_{k+1})$ and a partition of unity $(r_j)_{j=1}^k$ subordinate to $(U_j)_{j=1}^k$ on the restriction of \mathcal{L} to $\bigcup_{j \leq k} U_j$. Then we note that $((r_0 \cdot r_j)_{j=1}^k, r_{k+1})$ is a partition of unity subordinate to $(U_j)_{j=1}^{k+1}$.

We now suppose that the covering $(U_j)_j$ is constituted by only two subsets U_1 and U_2 . Let us define two close subsets F_1 and F_2 included in respectively U_1 and U_2 such that the union of F_1 with F_2 is equal to L .

If, for example, U_1 is equal to L , we choose $F_1 := L$ and $F_2 := \emptyset$. If neither U_1 neither U_2 is equal to L , we define

$$F_1 := \{x \in L; d(x, U_1^c) \geq d(x, U_2^c)\},$$

$$F_2 := \{x \in L; d(x, U_1^c) \leq d(x, U_2^c)\}.$$

Obviously, these two subsets cover L . Suppose, for the sake of contradiction, that F_2 is not included in U_2 . Thus, there exists a point x which belongs to $U_2^c \cap F_2$ and so satisfies

$$d(x, U_1^c) \leq d(x, U_2^c) = 0.$$

Consequently x belongs to the intersection of U_1^c with U_2^c which is empty, this is a contradiction. In the same way, we prove that F_1 is included in U_1 .

Let us now construct two nonnegative functions $r_1 \in \text{Mor}^r(\mathcal{L}, \mathbb{R})$ and $r_2 \in \text{Mor}^r(\mathcal{L}, \mathbb{R})$ which are nonzero at all points of respectively F_1 and F_2 , and have their support included in respectively U_1 and U_2 .

The following functions will then satisfy statement 2):

$$\rho_1 := \frac{r_1}{r_1 + r_2} \quad \text{and} \quad \rho_2 := \frac{r_2}{r_1 + r_2}.$$

Let us construct r_1 for example.

It follows from property A.1.1, that there exists an increasing sequence of compact subsets $(K_n)_n$ whose union is equal to L , and such that for any $n \geq 0$, the interior of K_{n+1} contains K_n . Let $C_n := K_n \setminus \text{int}(K_{n-1})$, with $K_{-1} = \emptyset$. Let $D_n := C_n \cap F_1$. For every $x \in D_n$, there exists $\eta_x^n > 0$ such that the ball $B(x, \eta_x^n)$ does not intersect K_{n-2} and is included in $K_{n+1} \cap U_1$. Let ρ_x^n be the function given by the first statement of this proposition with $\eta = \eta_x^n$. We denote by U_x^n the subset of points at which this function is nonzero. We note that the family of open subsets $(U_x^n)_{x \in D_n}$ is a covering of the compact subset D_n . Hence, there exists a finite subcovering $(U_{x_i}^n)_{i \in I_n}$. We remark that the family $(U_{x_i}^n)_{\{n \geq 0, i \in I_n\}}$ is a locally finite covering of F_1 and of union included in U_1 . Thus, the following function is appropriate:

$$r_1 := \sum_{n \geq 0, i \in I_n} \rho_{x_i}^n.$$

3) Let $f \in C^0(L, \mathbb{R})$ and $\epsilon > 0$. Let us construct a function $f' \in \text{Mor}^r(\mathcal{L}, \mathbb{R})$ satisfying

$$\sup_{x \in L} |f(x) - f'(x)| \leq \epsilon.$$

Let $(U_i)_i$ be a locally finite covering of L by precompact distinguish open subsets. For each i , let $\phi_i : U_i \rightarrow \mathbb{R}^d \times T_i$ be a chart. We denote by ϕ_{i1} and ϕ_{i2} its coordinates. Let $(\rho_i)_i \in \text{Mor}^r(\mathcal{L}, \mathbb{R})^{\mathbb{N}}$ be a partition of unity subordinate to $(U_i)_i$. Let $W_i := U_i \setminus \rho^{-1}(\{0\})$ which is precompact in U_i .

Let $r \in C^\infty(\mathbb{R}^d, \mathbb{R}^+)$ be a function whose support is included in the unity ball and whose integral is equal to 1.

For each i , let $\epsilon_i > 0$ small such that the following function is well defined:

$$f_i : W_i \longrightarrow \mathbb{R}, \quad x \longmapsto \frac{1}{\epsilon_i^d} \int_{B(0, \epsilon_i)} f(\phi_i^{-1}(\phi_{i1}(x) + y, \phi_{i2}(x))) \cdot r\left(\frac{y}{\epsilon_i}\right) dy$$

and satisfies $\sup_{W_i} |f_i - f| < \epsilon$.

From the classical properties of convolutions, the following function satisfies all the required properties:

$$x \longmapsto \sum_{\{i; x \in U_i\}} \rho_i(x) \cdot f_i(x). \quad \square$$

A.1.2. Partition of unity controlled on a stratification of laminations

PROPOSITION A.1.3. — Let (A, Σ) be a stratified space endowed with a C^r -trellis structure \mathcal{T} , with $r \geq 1$.

- 1) For all $\eta > 0$ and $x \in A$, there exists a nonnegative function $\rho \in \text{Mor}^r(\mathcal{T}, \mathbb{R})$ whose support is included in $B(x, \eta)$ and such that $\rho(x)$ is positive.
- 2) For any $\eta > 0$ and any function ρ_0 continuous on A , there exists a C^r - \mathcal{T} -controlled function ρ on A such that

$$\sup_{x \in A} |\rho(x) - \rho_0(x)| \leq \eta.$$

- 3) Given an open covering $(U_i)_{i \in I}$ of A , there exists $(\rho_i)_i \in \text{Mor}^r(\mathcal{T}, \mathbb{R}^+)^I$ such that the support of ρ_i is included in U_i and $\sum_i \rho_i = 1$. We say that $(\rho_i)_i$ is a partition of unity subordinate to $(U_i)_i$.

Proof. — Let us show statement 1) and 2) in the same times. We will replace all the propositions about the sign of the constructed functions by, respectively, the propositions about the distance to ρ_0 of the constructed functions.

We denote by $(X_p)_p$ and $(L_p, \mathcal{L}_p)_p$ the laminations forming from Σ and \mathcal{T} , by property 1.3.20. We are going to construct, by induction on $k \geq 0$, a continuous function ρ_k on A such that:

- for $j \leq k$, $\rho_k|_{L_j}$ is a morphism from \mathcal{L}_j to \mathbb{R} ;
- for $j \leq k$, the restriction to X_j of ρ_k is equal to the one of ρ_j ;
- ρ_k is nonzero at x , nonnegative on A and with support included in $B(x, (1 - 2^{-k-1}) \cdot \eta)$ (resp. $\sup_A |\rho_k - \rho| \leq (1 - 2^{-k-1}) \cdot \eta$).

For the step $k = 0$, we simply choose a continuous function ρ_0 on A , nonnegative, with support included in $B(x, \frac{1}{2}\eta)$ and such that $\rho_0(x) > 0$ (resp. for the step $k = 0$, we chose the function ρ_0 given in the hypotheses).

We suppose the induction hypothesis satisfied for $k \geq 0$. By property A.1.1, there exists a locally finite open covering $(W_i)_i$ of L_{k+1} , such that each open subset W_i is precompact in a distinguish open subsets of \mathcal{L}_{k+1} . By splitting each of these open subsets into smaller, we may also suppose that the diameter of W_i is less than the distance from W_i to the complement of L_{k+1} .

For each $j \leq k+1$, we fix a Riemannian metric on (L_j, \mathcal{L}_j) . For any open subset W in L_j and $\lambda \in \text{Mor}^r(\mathcal{L}_j|_W, \mathbb{R})$, we define

$$\|\lambda\|_{\text{Mor}^r(\mathcal{L}_j|_W, \mathbb{R})} := \sup_{x \in W} \left(\sum_{s=1}^r \|\partial_{T_x \mathcal{L}_j}^s \lambda\| \right),$$

where the s -linear norm $\|\cdot\|$ is subordinated to the induced norm by the Riemannian metric on $T_x \mathcal{L}_j$ and to the Euclidean norm on \mathbb{R} .

We chose then a partition of unity $(\lambda_i)_i \in \text{Mor}^r(\mathcal{L}_{k+1}, \mathbb{R}^+)^{\mathbb{N}}$ subordinate to $(W_i)_i$. For each i , we define

$$\epsilon_i := \frac{\eta}{2^{k+2+i}} \cdot \min \left(1, \frac{\text{diam}(W_i)}{\|\lambda_i\|_{\text{Mor}^r(\mathcal{L}_{k+1}|_{W_i}, \mathbb{R})}} \right) > 0.$$

For each i , we apply the following lemma shown at the end:

LEMMA A.1.4. — *There exists a function $\rho'_i \in \text{Mor}^r(\mathcal{L}_{k+1}|W_i, \mathbb{R})$ such that:*

- 1) *If the closure W_i is included in L_j , for any $j \leq k$, we have then*

$$\|\rho_k|W_i - \rho'_i\|_{\text{Mor}^r(\mathcal{L}_j|W_i, \mathbb{R})} < \epsilon_i$$

And, in the case of the first statement, we have moreover

- 2) *the support of ρ'_i is included in the ϵ_i -neighborhood of the support of $\rho_k|W_i$;*
- 3) *the function ρ'_i is nonnegative, and if W_i contains x , then $\rho'_i(x)$ is positive.*

Let

$$\rho_{k+1} : y \mapsto \begin{cases} \sum_i \lambda_i(y) \cdot \rho'_i(y) & \text{if } y \in L_{k+1}, \\ \rho_k(y) & \text{otherwise.} \end{cases}$$

In the first statement case, ρ_{k+1} is a nonnegative function which is positive at x . As for each i the support of ρ'_i is included in the $\frac{\eta}{2^{k+2}}$ -neighborhood of ρ_k , the support of ρ_{k+1} is included in the $\frac{\eta}{2^{k+2}}$ -neighborhood of the support of ρ_k , so in $B(x, (1 - 2^{-k-2}) \cdot \eta)$.

In the second statement case, for $y \in L_{k+1}$, the number $|\rho_{k+1}(y) - \rho(y)|$ is less than

$$|\rho_k(y) - \rho(y)| + |\rho_k(y) - \rho_{k+1}(y)| \leq (1 - 2^{-k-1})\eta + \sum_i \lambda_i(y) \cdot \epsilon_i \leq (1 - 2^{-k-2}) \cdot \eta$$

and for $y \in L_{k+1}^c$, the number $|\rho_{k+1}(y) - \rho(y)|$ is equal to $|\rho_k(y) - \rho(y)|$ which is less than $(1 - 2^{-k-2}) \cdot \eta$.

Now, let us show that, for $j \leq k + 1$, the function $\rho_{k+1}|L_j$ is a C^r -morphism from \mathcal{L}_j to \mathbb{R} .

By local finiteness of the covering $(W_i)_i$, the map $\rho_{k+1}|L_{k+1}$ belongs to $\text{Mor}^r(\mathcal{L}_{k+1}, \mathbb{R})$. Thus, for $j \leq k$, the function $\rho_{k+1}|L_{k+1} \cap L_j$ belongs to $\text{Mor}^r(\mathcal{L}_j|L_{k+1} \cap L_j, \mathbb{R})$. Moreover, for $y \in L_{k+1}$,

$$|\rho_k(y) - \rho_{k+1}(y)| \leq \sum_i \lambda_i(y) \cdot |\rho'_i(y) - \rho_k(y)| \leq \sum_{i; x \in W_i} \epsilon_i \leq \sum_{i; x \in W_i} \frac{\eta \cdot \text{diam } W_i}{2^{i+2}},$$

$$(19) \quad \implies |\rho_k(y) - \rho_{k+1}(y)| \leq \eta \cdot d(y, L_{k+1}^c).$$

Hence, the function ρ_{k+1} is continuous.

For any $i \leq k$ and $x_0 \in L_i \setminus L_{k+1}$, there exists $r > 0$ such that the ball $B(x_0, r)$ is included in L_i . If any W_j intersects $B(x_0, \frac{1}{2}r)$, then the closure of W_j is contained in L_i . Thus, for every $y \in B(x_0, \frac{1}{2}r) \cap W_j$, the number $\|\partial_{T\mathcal{L}_i}(\rho_k - \rho_{k+1})(y)\|$ is less than

$$\sum_{\{j; W_j \ni y\}} \sum_{k=0}^s C_s^k \underbrace{\|\partial_{T\mathcal{L}_i}^{s-k} \lambda_j(y) \cdot \partial_{T\mathcal{L}_i}^k (\rho'_j(y) - \rho_k(y))\|}_{\leq \frac{\eta}{2^{k+2+j}} \text{diam } W_j}.$$

As $\text{diam } W_j \leq d(y, x_0)$, we have

$$(20) \quad \|\partial_{T\mathcal{L}_i}(\rho_k - \rho_{k+1})(y)\| \leq \eta \sum_{k=0}^s C_s^k \cdot d(y, x_0).$$

From equations (19) and (20), the restriction $\rho_{k+1}|_{L_i}$ is a C^r -morphism from \mathcal{L}_i into \mathbb{R} , for each $i \leq k$.

As Σ is locally finite, the family $(L_k)_k$ is also locally finite. Thus, the sequence $(\rho_k)_k$ is locally eventually constant. Let ρ be the limit of $(\rho_k)_k$. Therefore, this sequence satisfies, for any $k \geq 0$, that $\rho|_{L_k}$ belongs to $\text{Mor}^r(\mathcal{L}_k, \mathbb{R})$. Hence, for all $X \in \Sigma$, the restriction of ρ to L_X is a C^r -morphism from \mathcal{L}_X to \mathbb{R} . Consequently, ρ is a \mathcal{T} -controlled C^r -morphism. Moreover, the first (resp. second) statement is checked.

3) We do exactly the same proof as for proposition A.1.2.2, by replacing ‘ L ’ by ‘ A ’ and ‘ $\text{Mor}^r(\mathcal{L}, \mathbb{R})$ ’ by ‘ $\text{Mor}^r(\mathcal{T}, \mathbb{R})$ ’. \square

Proof of lemma A.1.4. — Let (U, ϕ) be a chart of \mathcal{L}_{k+1} such that the closure of W_i is included in U . Let d_{k+1} be the dimension of \mathcal{L}_{k+1} , let V be an open subset of $\mathbb{R}^{d_{k+1}}$ and let τ be a locally compact metric space, such that

$$\phi : U \longrightarrow V \times \tau, \quad x \longmapsto (\phi_1(x), \phi_2(x)).$$

Let $r \in C^\infty(\mathbb{R}^{d_{k+1}}, \mathbb{R}^+)$ be a function with support included in the unity ball, nonnegative on this ball and with integral on $\mathbb{R}^{d_{k+1}}$ equal to 1. For any $x' \in W_i$, let

$$\rho'_i(x') = \frac{1}{\mu^{d_{k+1}}} \cdot \int_{y \in B(0, \mu)} \rho(z) \cdot r\left(\frac{y}{\mu}\right) dy,$$

with $z := \phi^{-1}(\phi_1(x') - y, \phi_2(x'))$ and $\mu > 0$ small enough for ϕ to be well defined. It follows from the classical properties of convolutions that the function ρ'_i is a morphism from $\mathcal{L}_{k+1}|_{W_i}$ to \mathbb{R} .

Let us prove 1). For this end, we now assume that x' belongs to $W_i \subset \text{cl}(W_i) \subset L_j$. By taking μ small enough, the point z (defined above) always belongs to L_i .

$$\implies \partial_{T_{x'}\mathcal{L}_i}^s \rho'_i = \frac{1}{\mu^{d_{k+1}}} \cdot \int_{y \in B(0, \mu)} \partial_{T_z\mathcal{L}_i}^s(\rho \circ z) \cdot r\left(\frac{y}{\mu}\right) dy, \quad \forall s \in \{1, \dots, r\}.$$

As, for $\mu > 0$ small and $y \in B(0, \mu)$, the map $x \mapsto z$ is C^r -close to the identity, the function $x \mapsto \rho \circ z$ is C^r -close to ρ . Therefore, by taking μ sufficiently small, we have

$$\|\rho|_W - \rho'_i\|_{\text{Mor}^r(\mathcal{L}_i|_W, \mathbb{R})} < \epsilon_i.$$

In the first assertion case, for μ small enough, conclusions 2) and 3) are then clear. \square

A.2. Density of smooth liftings of a smooth map

Throughout this section, we denote by G and M two Riemannian manifolds and $p : G \rightarrow M$ a C^∞ -bundle.

Given a family of numbers $(r_k)_{k=1}^n \in [0, 1]^n$ and given a family of points $(m_k)_{k=1}^n$ of a same fiber G_x of G and next to each other, using the Riemannian metric we may

define [17] the centroid $\text{cent}\{(m_k)_{k=1}^n, (r_k)_{k=1}^n\} \in G_x$ of the family of points $(m_k)_{k=1}^n$ weighted by the masses $(r_k)_{k=1}^n$ respectively. This centroid is a C^∞ -map from the product of the product bundle G^n over M , with $[0, 1]^n$, to G . The centroid does not depend on the indexation in $\{1, \dots, n\}$. Finally, if we add some points with zero masses, the centroid remains the same.

A.2.1. Density of smooth liftings of a morphism of a lamination. — Let (L, \mathcal{L}) be a lamination and let i be a morphism from (L, \mathcal{L}) to M .

PROPOSITION A.2.1. — *The subset of liftings of i in G which are C^r -morphisms from (L, \mathcal{L}) to G is dense in the space of the continuous liftings of i endowed with the strong C^0 -topology.*

Proof. — Let N be a continuous lifting of i and let ϵ be a positive number. Let us show the existence of a lifting $N' \in \text{Mor}^r(\mathcal{L}, G)$ of i such that

$$\sup_{x \in L} d(N(x), N'(x)) \leq \epsilon.$$

By property A.1.1, we may construct a locally finite covering $(U_k)_k$ of L , such that for each k , $N(U_k)$ is included into a precompact distinguish open subset V_k of the bundle G . This means that there exists a trivialization ϕ_k of class C^∞ from V_k onto $p(V_k) \times \mathbb{R}^d$:

$$\phi_k : V_k \xrightarrow{\sim} p(V_k) \times G_{x_k},$$

with $x_k \in p(V_k)$.

As N is a lifting of i , for each k , there exists a continuous map F_k from U_k into G_{x_k} , such that

$$\phi_k \circ N|_{U_k} : U_k \longrightarrow p(U_k) \times G_{x_k}, \quad x \longmapsto (i(x), F_k(x)).$$

By proposition A.1.2.2, there exists a partition of unity $(\rho_k)_k$ subordinate to $(U_k)_k$ and formed by functions in $\text{Mor}^r(\mathcal{L}, [0, 1])$.

Thus, by proposition A.1.2 3), there exists for each k , a morphism $F'_k \in \text{Mor}^r(\mathcal{L}|_{U_k}, \mathbb{R}^d)$ close enough to $F|_{U_k}$ such that:

— the following morphism of laminations is well defined:

$$N' : L \rightarrow G, \quad x \longmapsto \text{cent} \left\{ (F'_k(x))_{\{k; x \in U_k\}}, (\rho_k(x))_{\{k; x \in U_k\}} \right\};$$

— for each $x \in L$,

$$d(N'(x), N(x)) \leq \epsilon.$$

Finally, we note that N' is a lifting of i . □

A.2.2. Density of smooth controlled liftings of a controlled morphism. —

Let (A, Σ) be a stratified space endowed with a trellis structure \mathcal{T} and let i be a \mathcal{T} -controlled morphism into M .

PROPOSITION A.2.2. — *The subset of C^r -liftings of i into F which are \mathcal{T} -controlled is dense in the space of continuous liftings of i endowed with the strong C^0 -topology.*

Proof. — We do exactly the same proof as in proposition A.2.1, by replacing ‘ L ’ by ‘ A ’, ‘ \mathcal{L} ’ by ‘ \mathcal{T} ’, and proposition A.1.2 by proposition A.1.3. □

APPENDIX B

ADAPTED METRIC

In this chapter we prove the following proposition and property stated in section 2.1.3.1, where some notations used below are defined.

PROPOSITION 2.1.8. — *Let $r \geq 1$. Let (L, \mathcal{L}) be a lamination immersed by i into a Riemannian manifold (M, g) . Let $f \in \text{End}(M)$, $i \in \text{Im}(\mathcal{L}, M)$, and $f^* \in \text{End}(\mathcal{L})$. If f r -normally expands the immersed lamination \mathcal{L} over f^* , for every compact subset K of L stable by f^* ($f^*(K) \subset K$), there exist a Riemannian metric g' on M and $\lambda' < 1$ such that for the metric i^*g on $T\mathcal{L}$ and the norm induced by g' on i^*TM , it holds for every $v \in (i^*TM/T\mathcal{L})|K \setminus \{0\}$:*

$$\max(1, \|T_{\pi(v)}f^*\|^r) \cdot \|v\| < \lambda' \cdot \|[i^*Tf](v)\|.$$

PROPERTY 2.1.9. — *Let (L, \mathcal{L}) be a lamination immersed by i into a manifold M . Let $f \in \text{End}^1(M)$ which r -normally expands (L, \mathcal{L}) over $f^* \in \text{End}^1(\mathcal{L})$, for some $r \geq 1$. Let K be a compact subset of L sent into itself by f^* . Then there exist $\lambda > 1$, a Riemannian metric on M adapted to the r -normal expansion of \mathcal{L} over K and a (open) cone field C on $i(K)$ such that, for every $x \in i(K)$:*

- 1) $T_x\mathcal{L}^\perp$ is a maximal subspace of T_xM contained in C_x ;
- 2) $Tf(\text{cl}(C(x)))$ is included in $C(f(x)) \cup \{0\}$;
- 3) $\|Tf(u)\| > \lambda \cdot \|u\|$ for every $u \in C(x)$.

Proof of proposition 2.1.8. — The existence of an adapted metric when f is a diffeomorphism has been proved recently by Nikolaz Gourmelon [13]. In the following proof, we adapt some of his ideas.

Let B the compact set $i(K)$ of M and let F be the vector bundle $TM|B \rightarrow B$. Let F' be the vector bundle over B whose fiber at $y \in B$ is $Ti(T_x\mathcal{L})$ if x is sent by i to y . By property 2.1.6, F' is a well defined continuous vector bundle even if $i|K$ is not injective. We endow F with the norm induced by the Riemannian metric of M .

We denote by T the restriction of Tf to the bundle F , which is a morphism of this bundle over f . As T preserves the subbundle F' , this morphism defines a morphism, denoted by $[T]$, on the quotient bundle F/F' over B .

For $x \in B$ and $n \geq 0$, we define

$$m([T]^n(x)) := \min_{\substack{u \in (F/F')_x \\ \|u\|=1}} (\|[T]^n(u)\|).$$

By r -normal expansion and compactness of B , there exist $N > 0$ and $a < 1$ such that for every $x \in B$,

$$\max(1, \|T^N|F'_x\|^r) < a^{2N} \cdot m([T]^N(x)).$$

Therefore, there exists a function r on B , continuous and greater than 1, such that for every $x \in B$

$$\frac{1}{a} \sqrt[N]{\|T^N|F'_x\|^r} < r(x) < a \cdot \sqrt[N]{m([T]^N(x))}$$

We denote by R_n the continuous function on B defined by

$$R_n := x \longmapsto \prod_{i=0}^n r(f^i(x)).$$

We use now the following lemma proved at the end:

LEMMA B.0.3. — *There exists $c > 0$ such that, for all $x \in B$ and $n \geq 0$, we have*

$$\frac{\|T^n|F'_x\|}{\sqrt[n]{R_n(x)}} \leq c \cdot a^n \quad \text{and} \quad \frac{m([T]^n(x))}{R_n(x)} \geq c^{-1} \cdot a^{-n}.$$

So there exists $M \geq 0$ such that, for every $x \in B$, $m([T]^{M+1}(x))/R_{M+1}(x)$ is greater than $1/r(x)$. For every $(x, u) \in F$, let u_1 be the orthogonal projection of u onto F'_x and let u_2 be the equivalence class of $u - u_1$ in $(F/F')_x$. By lemma B.0.3, the following Euclidean norm is well defined and depends continuously on (x, u) :

$$\|(x, u)\|'^2 := \sum_{n=0}^{\infty} \frac{\|T^n(x, u_1)\|^2}{R_n(x)^{\frac{2}{r}}} + \sum_{n=0}^M \frac{\|[T]^n(x, u_2)\|^2}{R_n(x)^2}.$$

We remark that we have

$$\begin{aligned} \|T(x, u_1)\|'^2 &= \sum_{n=0}^{\infty} \frac{\|T^{n+1}(x, u_1)\|^2}{R_n(f(x))^{\frac{2}{r}}} \\ &= r(x)^{\frac{2}{r}} \cdot \sum_{n=1}^{\infty} \frac{\|T^n(x, u_1)\|^2}{R_n(x)^{\frac{2}{r}}} \leq r(x)^{\frac{2}{r}} \cdot \|(x, u_1)\|'. \end{aligned}$$

Hence, the norm induced by $\|\cdot\|'$ of $T|F'_x$ is less than $\sqrt[r]{r(x)}$.

If $u_2 \in (F/F')_x$ is nonzero, we have

$$\begin{aligned} \|[T](x, u_2)\|'^2 &= \sum_{n=0}^M \frac{\|[T]^{n+1}(x, u_2)\|^2}{R_n(f(x))^2} = r(x)^2 \cdot \sum_{n=1}^{M+1} \frac{\|[T]^n(x, u_2)\|^2}{R_n(x)^2} \\ &= r^2(x) \cdot \left(\|(x, u_2)\|'^2 + \frac{\|[T]^{M+1}(x, u_2)\|^2}{R_{M+1}(x)^2} - \frac{\|(x, u_2)\|^2}{r(x)^2} \right) \\ &> r^2(x) \cdot \|(x, u_2)\|'^2. \end{aligned}$$

Therefore, the real number $\|[T](x)^{-1}\|'^{-1}$ is greater than $r(x) > 1$.

It follows from the two last conclusions that for every $x \in B$,

$$\|[T](x)^{-1}\|' \cdot \max(1, \|T|F'_x\|'^r) < 1.$$

By compactness of B , there exists an upper bound $\lambda' < 1$ such that for $x \in B$, we have

$$\|[T](x)^{-1}\|' \cdot \max(1, \|T|F'_x\|'^r) < \lambda'.$$

We extend the Euclidean norm $\|\cdot\|'$ on $F = TM|B$ to a continuous Riemannian metric g'' on TM . We chose then a C^∞ -Riemannian metric g' on M , close enough to g'' to have, with the norm induced by g' on i^*TM :

$$\forall v \in (i^*TM/T\mathcal{L})|K \setminus \{0\}, \quad \max(1, \|T_{\pi(v)}f^*\|^r) \cdot \|v\| < \lambda' \cdot \|[i^*Tf](v)\|.$$

□

Proof of lemma B.0.3. — Let

$$C := \max_{x \in B} (\|T|F'_x\|, \|[T](x)^{-1}\|, r(x)) > 1 \quad \text{and} \quad c := C^{4N} \cdot a^{-2N}.$$

For every $n \in \mathbb{N}$, let $q \in \mathbb{N}$ and $p \in \{0, \dots, N-1\}$ be such that $n = q \cdot N + p$. For $x \in B$, we have

$$R_n(x) = \prod_{i=0}^{N-1} \prod_{j=0}^{q-1} r(f^{i+jN}(x)) \cdot \prod_{k=0}^p r(f^{qN+k}(x)).$$

The first inequality of this lemma, when $q \geq 2$, is obtained by the following calculus:

$$\begin{aligned} \sqrt[q]{R_n(x)} &\geq \prod_{i=0}^{N-1} \prod_{j=0}^{q-2} \frac{\sqrt[q]{\|T^N|F'_{f^{i+jN}(x)}\|}}{a} \geq \prod_{i=0}^{N-1} \frac{\sqrt[q]{\|T^{N(q-1)}|F'_{f^i(x)}\|}}{a^{q-1}} \\ &\Rightarrow \sqrt[q]{R_n(x)} \geq \prod_{i=0}^{N-1} \frac{\sqrt[q]{\|T^n|F'_x\|}}{a^{q-1} \cdot C^2} \geq C^{-2N} \cdot a^{2N} \frac{\|T^n|F'_x\|}{a^n} \geq c^{-1} \cdot \frac{\|T^n|F'_x\|}{a^n}. \end{aligned}$$

If $q \leq 1$, then $n < 2N$ and $\sqrt[q]{R_n(x)} \geq 1 \geq c^{-1} \|T^n|F'_x\|/a^n$.

The second inequality of this lemma, when $q \geq 2$, is obtained by the following calculus:

$$\begin{aligned} R_n(x) &\leq \prod_{i=0}^{N-1} \prod_{j=0}^{q-2} \left(a \cdot \sqrt[q]{m([T]^N(f^{i+jN}(x)))} \right) \cdot C^{N+p} \\ &\Rightarrow R_n(x) \leq \prod_{i=0}^{N-1} \left(a^{q-1} \cdot \sqrt[q]{m([T]^{N(q-1)}(f^i(x)))} \right) \cdot C^{2N} \\ &\Rightarrow R_n(x) \leq \prod_{i=0}^{N-1} \left(a^q \cdot C^2 \cdot \sqrt[q]{m([T]^n(x))} \right) \cdot a^{-N} \cdot C^{2N} \leq c \cdot a^n \cdot m([T]^n(x)). \end{aligned}$$

If $q \leq 1$, then $n < 2N$ and $R_n(x) \leq C^{2N} \leq c \cdot a^n \cdot m([T]^n(x))$.

□

Proof of property 2.1.9. — We endow M with an adapted Riemannian metric to the normal expansion of f on K . Let $x \in i(K)$, let $u \in T_y\mathcal{L}$ be a unitary vector and let $v \in T_y\mathcal{L}^\perp$ be small. Then we have

$$\tan \angle(T_x f(u+v), T_{f(x)}\mathcal{L}^\perp) = \frac{\|p_\perp \circ T_x f(v)\|}{\|p_T \circ T_x f(v) + T_x f(u)\|},$$

where p_T and p_\perp are respectively the orthogonal projection of $T_x M$ onto $T_x\mathcal{L}$ and $T_x\mathcal{L}^\perp$ respectively. We have,

$$\frac{\|p_T \circ T_x f(v) + T_x f(u)\|}{\|p_\perp \circ T_x f(v)\|} \geq \frac{\|T_x f(u)\|}{\|p_\perp \circ T_x f(v)\|} - C$$

with $C = \sup \|p_T T_x f(v)\|/\|p_\perp T_x f(v)\|$. Thus, by 1-normal expansion

$$\tan \angle(T_x f(u+v), T_{f(x)}\mathcal{L}^\perp) \geq \lambda^{-1} \cdot \frac{\|u\|}{\|v\|} - C = \frac{\tan \angle(u+v, T_x\mathcal{L}^\perp)}{\lambda} - C.$$

Thus, for $\epsilon > 0$ small enough, properties 1) and 2) are satisfied by the following cone field:

$$C_x := \{(u+v) \in TM : u \in T\mathcal{L}, v \in T\mathcal{L}^\perp \text{ and } \|v\| > \epsilon\|u\|\}.$$

Let $\eta > 0$ and let g' be the following inner product on $TM|i(K)$:

$$g' := \eta \cdot g|T\mathcal{L} + g|T\mathcal{L}^\perp.$$

For every $w \in C(x)$, we have

$$g'(w) = \eta \cdot g(u) + g(v),$$

where $u \in T_x\mathcal{L}$ and $v \in T_x\mathcal{L}^\perp$ satisfy $w = u + v$.

By normal expansion, we have the existence of $\lambda' > 1$ which does not depend on x , such that

$$g'(Tf(w)) = \eta \cdot g(p_T \circ Tf(v) + Tf(u)) + g(p_\perp \circ Tf(v)) \geq \lambda'^2 g(v).$$

As $\epsilon \cdot \|u\| < \|v\|$, we have

$$g'(Tf(w)) \geq (\lambda'^2 - \eta/\epsilon^2)g(v) + \eta \cdot g(u).$$

Thus, for $\eta > 0$ sufficiently small, $(\lambda'^2 - \eta/\epsilon^2)$ is greater than 1 and we get conclusion 3). We can extend g' to a Riemannian metric on M . We notice that g' is as much adapted as g to the C^r -normal expansion. \square

APPENDIX C

PLAQUE-EXPANSIVENESS

The definition of the plaque-expansiveness in the diffeomorphism context and the endomorphism context are different and recalled in section 2.1.3.3.

The plaque-expansiveness is satisfied in all the known examples of compact lamination normally expanded or hyperbolic. Nevertheless, we do not know if every compact lamination, normally expanded or hyperbolic are plaque-expansive. Moreover, we do not know if this hypothesis is necessary for a lamination to be persistent (as an embedded lamination).

C.1. Plaque-expansiveness in the diffeomorphism context

In the diffeomorphism context, up to our knowledge there exist essentially two results, both were proved in [15]. In order to state the first result, let us recall that a lamination (L, \mathcal{L}) embedded into a manifold is *locally* a saturated subset of a C^1 -foliation if for every $x \in L$ there exists a C^1 -foliation \mathcal{F} , on a neighborhood U of x , such that $\mathcal{L}|_U \cap L$ is equal to $\mathcal{F}|_U \cap L$.

PROPERTY C.1.1 (Hirsch-Pugh-Shub). — *Let (L, \mathcal{L}) be a compact lamination embedded into a manifold M . Let f be a diffeomorphism normally hyperbolic to this lamination. Then f is plaque-expansive if (L, \mathcal{L}) is locally a saturated subset of a C^1 -foliation.*

The second result was generalized in [29] and require the definition of the *Lyapunov stability*:

DEFINITION C.1.2. — Let f be a diffeomorphism of a manifold M preserving a compact lamination (L, \mathcal{L}) embedded into M . The diffeomorphism f is *Lyapunov stable* along \mathcal{L} if for every small $\epsilon > 0$, there exists $\delta > 0$ such that, for all $x \in L$ and $n \geq 0$, the plaque⁽¹⁾ $f^n(\mathcal{L}_x^\delta)$ is included in $\mathcal{L}_{f^n(x)}^\epsilon$.

1. Recall that we denote by \mathcal{L}_x^δ the union of the plaques whose diameter is less than δ and which contains x .

We remark that if the restriction of f to the leaves of \mathcal{L} is an isometry then f is Lyapunov stable along \mathcal{L} .

PROPOSITION C.1.3 (Rodriguez Hertz-Ures). — *Let (L, \mathcal{L}) be a compact lamination embedded into a manifold M . Let f be a diffeomorphism of M which preserves (L, \mathcal{L}) .*

- *If f is Lyapunov stable along \mathcal{L} and normally expands this lamination, then f is plaque-expansive.*
- *If f is normally hyperbolic on this lamination and if f and f^{-1} are Lyapunov stable along \mathcal{L} , then f is plaque-expansive.*

C.2. Plaque-expansiveness in the endomorphism context

In the endomorphism context, we have generalized a little bit the above result:

PROPOSITION C.2.1. — *Under the hypotheses of theorem 2.1.10, we suppose moreover that the lamination (L, \mathcal{L}) is embedded. Let $\mathcal{L}' := \mathcal{L}|_{L'}$. We suppose that there exist $A > 0$ and $\delta > 0$ such that, for every $x \in L'$, the subset \mathcal{L}'^A_x is precompact in the leaf of x , and we have for any $n \geq 0$*

$$f^n(\mathcal{L}'^\delta_x) \subset \mathcal{L}'^A_{f^n(x)}.$$

Then f is plaque-expansive at (L', \mathcal{L}') .

Proof. — This proof uses several ideas from [29], in particular the one where we consider the forward iterates of pseudo-orbits.

As L' is precompact, we may suppose that the metric of M satisfies property 2.1.9 for the compact subset $K = cl(L')$. We denote by \exp the exponential map associated to this metric. Thus, there exists a cone field over L' in $TM|_{L'}$ such that, for each $x \in L'$, $T_x\mathcal{L}^\perp$ is a maximal vector subspace included in $C(x)$ and satisfies moreover: *there exist a small $\epsilon_0 > 0$ and $\lambda > 1$ such that, for all $x \in L'$ and $u \in C(x)$ with norm less than ϵ_0 , we have*

$$(21) \quad v := \exp_{f(x)}^{-1} \circ f \circ \exp_x(u) \in C(f(x)) \quad \text{and} \quad \|v\| \geq \lambda\|u\|.$$

By precompactness, for $\epsilon_0 > 0$ sufficiently small, there exists $\eta > 0$ such that for every $(x, y) \in L'^2$ satisfying $y = \exp_x(u)$, with $u \in C(x)$ of norm in $[\epsilon_0/\sup_{L'}\|Tf\|, \epsilon_0]$, we have

$$(22) \quad d(\mathcal{L}'^A_x, \mathcal{L}'^A_y) > \eta.$$

Let $p \in \mathbb{N}$ such that $\lambda^p \cdot \eta > \epsilon_0$. We can also suppose that δ is less than $\epsilon_0/\sup_{L'}\|Tf\|^p$.

FACT C.2.2. — *There exists a small $\epsilon \in]0, \epsilon_0[$ such that, for every pair of ϵ -pseudo-orbits $(x_n)_n$ and $(y_n)_n$ which respect \mathcal{L}' and satisfy*

$$d(x_n, y_n) < \epsilon \quad \text{and} \quad y_n \notin \mathcal{L}'^\epsilon_{x_n}, \quad \forall n \geq 0,$$

there exists a sequence $(z_n)_n \in L'^{\mathbb{N}}$ such that, for every $n \geq 0$, z_n belongs to the intersection of $\exp_{x_n}(B_{C(x_n)}(0, \delta))$ with a small plaque containing y_n (but not x_n). For $\epsilon > 0$ small enough, $f^p(z_n)$ belongs to $\mathcal{L}'^\delta_{z_{n+p}}$ and $f^p(x_n)$ belongs to $\mathcal{L}'^\delta_{x_{n+p}}$.

We have proved this proposition if there do not exist such pseudo-orbits $(x_n)_n$ and $(y_n)_n$. We suppose, for the sake of contradiction, that there exist such sequences $(x_n)_n$ and $(y_n)_n$, and so $(z_n)_n$.

The fact C.2.2 implies that, for all $k \geq 0$ and $j \geq 0$, the sequences $(f^k(x_{pn+j}))_n$ and $(f^k(z_{pn+j}))_n$ are A -pseudo-orbits of f^p which respect \mathcal{L}' .

For $k \geq 0$, let $M_k := \sup_n d(f^k(x_n), f^k(z_n))$. The number M_0 belongs to $]0, \epsilon_0 / \sup_{L'} \|Tf\|^p[$. Moreover, if $M_j < \epsilon_0$ for every $j \leq k$, by (21) and the fact C.2.2, the number M_{k+1} belongs to $[\lambda M_k, \sup_{L'} \|Tf\| M_k]$. Thus, there exists $k_0 \geq 0$ such that M_{k_0+p} belongs to $] \epsilon_0 / \sup_{L'} \|Tf\|, \epsilon_0 [$ and M_j is less than ϵ_0 for $j \leq k_0 + p$. Hence, there exists $n_0 \geq 0$ such that

$$d(f^{k_0+p}(x_{n_0}), f^{k_0+p}(z_{n_0})) \in \left[\frac{\epsilon_0}{\sup_{L'} \|Tf\|}, \epsilon_0 \right].$$

Therefore, by (22), we have

$$d(f^{k_0}(x_{n_0+p}), f^{k_0}(z_{n_0+p})) > \eta.$$

Consequently, as $\lambda^p \eta$ is greater than ϵ_0 , we have

$$d(f^{k_0+p}(x_{n_0+p}), f^{k_0+p}(z_{n_0+p})) > \epsilon_0$$

This contradicts $M_{k_0+p} \leq \epsilon_0$. □

REMARK C.2.3. — Under the hypotheses of theorem 2.1.10, if the leaves of \mathcal{L} are the connected components of the fibers of a bundle, then f^* is plaque-expansive at \mathcal{L}' , by proposition C.2.1.

The following is equivalent, in the endomorphism context, to property C.1.1:

PROPERTY C.2.4. — *Under the hypotheses of theorem 2.1.10, we suppose moreover that (L, \mathcal{L}) is embedded. We denote by \mathcal{L}' the lamination $\mathcal{L}|L'$. If \mathcal{L} is locally a saturated subset of a C^1 -foliation, then f is plaque-expansive at (L', \mathcal{L}') .*

Proof. — We suppose that M is endowed with a metric which satisfies property 2.1.9 for the compact subset $K = \text{cl}(L')$. We denote by \exp the exponential map associated to this metric. Thus, there exists a cone field C on L' in $TM|L'$ such that, for each $x \in L'$, $T_x \mathcal{L}^\perp$ is a maximal vector subspace included in $C(x)$ and which satisfies moreover: *there exist $\epsilon_0 > 0$ and $\lambda > 1$ such that, for all $x \in L'$ and $u \in C(x)$ with norm less than ϵ_0 , we have*

$$(23) \quad v := \exp_{f(x)}^{-1} \circ f \circ \exp_x(u) \in C(f(x)) \quad \text{and} \quad \|v\| \geq \lambda \|u\|.$$

Moreover, for ϵ_0 small enough, by the C^1 -foliation hypothesis, there exists a number $C > 0$ such that, for all $(x, y) \in L'^2$, if y belongs to $\exp(C(x) \cap B_{T_x M}(0, \epsilon_0))$, the distance $d(\mathcal{L}_x^{\epsilon_0}, \mathcal{L}_y^{\epsilon_0})$ is greater than $Cd(x, y)$. Let $p \geq 0$ such that $C\lambda^p > 2$. Then there exists $\epsilon_1 \in]0, \epsilon_0[$ small enough such that for every ϵ_1 -pseudo-orbit $(x_n)_n$ which respects \mathcal{L}' , the sequence $(x_{np})_n$ is an ϵ_0 -pseudo-orbit of f^p which respects \mathcal{L}' .

There exists $\epsilon \in]0, \epsilon_1[$ such that, for every pair $((x_n)_n, (y_n)_n)$ of ϵ -pseudo-orbits of f , which respects \mathcal{L}' and satisfies

$$d(x_n, y_n) < \epsilon, \quad \forall n \geq 0,$$

there exists $z_n \in \mathcal{L}'_{y_n}{}^{2\epsilon}$ such that z_n belongs to $\exp(C(x_n) \cap B(0_{x_n}, \epsilon_0))$, the distance $d(z_n, x_n)$ is less than ϵ_1 and $(z_n)_n$ is an ϵ_1 -pseudo-orbit of f^* which respects \mathcal{L}' .

Consequently, the sequences $(z_{pn})_n$ and $(x_{pn})_n$ are ϵ_0 -pseudo-orbits of f^p which respect the plaques of \mathcal{L}' , such that z_{pn} belongs to $\exp(C(x_{pn}) \cap B(0_{x_{pn}}, \epsilon_0))$ and such that the distance $d(z_{pn}, x_{pn})$ is less than ϵ_0 .

Thus, the distance $d(f^p(z_{pn}), f^p(x_{pn}))$ is greater than $\lambda^p d(z_{pn}, x_{pn})$. Moreover, the distance $d(f^p(z_{pn}), f^p(x_{pn}))$ is less than $d(z_{p(n+1)}, x_{p(n+1)})/C$. Therefore, the distance $d(z_{p(n+1)}, x_{p(n+1)})$ is twice greater than $d(z_{pn}, x_{pn})$. We conclude that $d(z_{pn}, x_{pn})$ is greater than $2^n d(z_0, x_0)$ and less than ϵ_0 , this implies the equality of x_0 and z_0 . Thus, x_0 belongs to $\mathcal{L}'_{y_0}{}^{2\epsilon}$. \square

REMARK C.2.5. — Under the hypotheses of theorem 2.2.11, if for each stratum $X \in \Sigma|A'$ the hypotheses of the proposition or the above property are satisfied on a precompact subset L' of X , such that

$$(24) \quad \begin{cases} f^*(\text{cl}(L')) \subset L', & \text{cl}(L') \subset \text{int}(f^{*-1}(\text{cl}(L'))), \\ \bigcup_{n \geq 0} f_{|A'}^{*-n}(\text{cl}(L')) = X, \end{cases}$$

we can reduce and extend the plaque-expansiveness constant on L' to a continuous positive function ϵ on X , for which f^* is plaque-expansive at X (as in section 3.4). We note that there always exists an precompact open subset satisfying condition (24): for example we can take $\text{int}(K_p) \cap X'_p$ for the stratum X'_p , with the notation of the demonstration of theorem 2.2.11.

APPENDIX D

PRESERVATION OF LEAVES AND OF LAMINATIONS

We now give examples of diffeomorphisms preserving the leaves of immersed laminations but not the laminations.

EXAMPLE D.0.6. — Let (L, \mathcal{L}) be the circle \mathbb{S}^1 and let i be the immersion from \mathbb{S}^1 into \mathbb{R}^2 represented below:

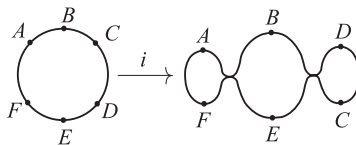

FIGURE 1

Let f be the diffeomorphism of \mathbb{R}^2 , preserving $i(\mathbb{S}^1)$ and such that $f|i(\mathbb{S}^1)$ is homotopic to the symmetry of axis (BE) . One notes therefore that f does not pull back to \mathbb{S}^1 .⁽¹⁾

EXAMPLE D.0.7. — Let \mathbb{T}^2 be the torus which is the quotient $\mathbb{R}^2/\mathbb{Z}^2$. Let f be the diffeomorphism of \mathbb{T}^2 , whose lift in \mathbb{R}^2 is the linear map, with matrix

$$\begin{bmatrix} 2 & 1 \\ 1 & 1 \end{bmatrix}.$$

Let $i: \mathbb{T}^2 \rightarrow \mathbb{T}^2$ be a 2-covering map of \mathbb{T}^2 . Hence i is an immersion, but there does not exist any pullback of f into \mathbb{T}^2 via i .

Proof. — We suppose, for the sake of contradiction, that there exists an endomorphism f^* of f . As f fixes the point 0, f^* preserves the fiber $i^{-1}(\{0\})$ that we denote by $\mathbb{Z}/2\mathbb{Z}$.

1. Actually this example is similar to the example P70 of [15], but we allow f to be a diffeomorphism.

Given two integers (a, b) , we denote by $\text{hol}_{(a,b)}$ the automorphism of the fiber $\mathbb{Z}/2\mathbb{Z}$ obtained by holonomy along a closed path of \mathbb{T}^2 pointed in 0 and tangent to the vector (a, b) . By commutation of the diagram, we have for any integers a, b

$$(25) \quad \text{hol}_{A(a,b)} \circ f^* = f^* \circ \text{hol}_{(a,b)} .$$

We remark that $f^*_{\mathbb{Z}/2\mathbb{Z}}$ is either an automorphism or a non-bijective map. If $f^*|_{\mathbb{Z}/2\mathbb{Z}}$ is non-bijective, we may suppose that f^* sends $\mathbb{Z}/2\mathbb{Z}$ onto $\{0\}$. The above equation implies that

$$\text{hol}_{A(a,b)}(0) = 0, \quad \forall (a, b) \in \mathbb{Z}^2 .$$

But this is not possible because the covering is connected.

If $f^*_{\mathbb{Z}/2\mathbb{Z}}$ is an automorphism, as $\text{Aut}(\mathbb{Z}/2\mathbb{Z}) \cong \mathbb{Z}/2\mathbb{Z}$ is commutative, equation (25) implies

$$\text{hol}_{A(a,b)} = \text{hol}_{(a,b)}, \quad \forall (a, b) \in \mathbb{N}^2 .$$

As \mathbb{T}^2 is connected, we have three possibilities for the morphism hol :

- $\text{hol}_{(1,0)} = +1$ and $\text{hol}_{(0,1)} = +1$. Then $\text{hol}_{A(0,1)} = 1 + 1 = 0$ is not equal to $\text{hol}_{(0,1)} = 1$.
- $\text{hol}_{(1,0)} = +1$ and $\text{hol}_{(0,1)} = +0$. Then $\text{hol}_{A(1,0)} = 2 + 0 = 0$ is not equal to $\text{hol}_{(1,0)} = 1$.
- $\text{hol}_{(1,0)} = +0$ and $\text{hol}_{(0,1)} = +1$. Then $\text{hol}_{A(1,0)} = 0 + 1 = 1$ is not equal to $\text{hol}_{(1,0)} = 0$. □

Both above examples standardize the following question of Hirsch-Pugh-Shub (see [15, p. 70]):

QUESTION D.0.8. — Let N be a manifold immersed by i into a manifold M and let f be a diffeomorphism of M which preserves the leaves of N .

Does there exist any immersion i' from N into M , whose image is the same as the image of i and such that f pullback to N via i' ?

Negative answer to this question D.0.8. — The idea of the proof is to use example D.0.7, by obliging i to be a 2-covering. To do it, as an algebraic geometer, we blow up \mathbb{T}^2 at the fixed point 0 of the diffeomorphism f of \mathbb{T}^2 . Hence, we obtain a diffeomorphism $f^\#$ of the connected sum $M^\# := \mathbb{T}^2 \# \mathbb{P}^2(\mathbb{R})$. As there exists a 2-covering of the torus by the torus, there exist a 2-covering of $M^\#$ by the manifold $\widehat{M}^\# := \mathbb{T}^2 \# \mathbb{P}^2(\mathbb{R}) \# \mathbb{P}^2(\mathbb{R})$. Such a covering is an immersion from $\widehat{M}^\#$ to $M^\#$, whose image is obviously $f^\#$ -invariant.

Any immersion j from $\widehat{M}^\#$ onto $M^\#$ is a 2-covering. Indeed, the compact manifold $\widehat{M}^\#$ has finite volume and so the map j is a k -covering. As the Euler constant of $\widehat{M}^\#$ is equal to -2 which is twice the Euler constant of $M^\#$, the map j is a 2-covering (since a triangulation of $M^\#$ small enough has all vertices, edges or faces which are k -times lifted in $\widehat{M}^\#$).

To reply to the question, it is sufficient to prove that there does not exist any 2-covering map from $\widehat{M}^\#$ onto $M^\#$, such that $f^\#$ pullback to $\widehat{M}^\#$.

We suppose, for the sake of contradiction, that there exists such a 2-covering map j .

The point $0 \in \mathbb{T}^2$ was blowing up to a circle \mathbb{S}^1 and a small neighborhood of 0 was blowing up to a Möbius strip. The preimage by j of this strip is either two disjoint Möbius strips or an annulus. In the first case, the restriction of j to each of these strips is a homeomorphism. In the second case, the restriction of j to the annulus is a 2-covering.

In the first case, we can blow down $M^\#$ and $\widehat{M}^\#$ at the circle S^1 and its preimages by j . Hence, we make up a pull back of f in a 2-covering of the torus \mathbb{T}^2 . Then, example D.0.7 implies a contradiction. However in the second case, we cannot blow down at the preimage of \mathbb{S}^1 . Let us use a little trick in the second case.

Let $\widehat{\mathbb{S}}^1$ be the circle which is the unique preimage of \mathbb{S}^1 . We cut along $\widehat{\mathbb{S}}^1$ the surface $\widehat{M}^\#$. This makes a surface $\widehat{M}'^\#$ with two boundaries B_1 and B_2 . Each of these boundaries is a 2-covering of \mathbb{S}^1 via the immersion j' from $\widehat{M}'^\#$ onto $M^\#$, canonically made up from j . We now identify the points of B_1 (resp. B_2) which have the same image into \mathbb{S}^1 via j' .

This constructs a new surface $\widehat{M}'^\#$ sent 2-1 onto $M^\#$, for which the preimage of a small neighborhood of \mathbb{S}^1 consists of two Möbius strips.

The argument of the first case conclude the proof if we show that $\widehat{M}'^\#$ is connected. In order to do so, we remark that $\widehat{M}^\# \setminus \mathbb{S}^1$ must be connected. Otherwise $\widehat{M}^\# \setminus \mathbb{S}^1$ would be the disjoint union of two surfaces which project onto $M^\# \setminus \mathbb{S}^1$ and so homeomorphic to the punctured torus. It comes that $\widehat{M}^\#$ would be the connected sum of two tori, this is a contradiction. \square

BIBLIOGRAPHY

- [1] ARNOL'D (V. I.), GUSEĪN-ZADE (S. M.) & VARCHENKO (A. N.) – *Singularities of differentiable maps. Vol. I*, Monographs in Mathematics, vol. 82, Birkhäuser Boston Inc., Boston, MA, 1985, The classification of critical points, caustics and wave fronts, Translated from the Russian by Ian Porteous and Mark Reynolds.
- [2] BEKKA (K.) – *C-régularité et trivialité topologique*, in *Singularity theory and its applications, Part I (Coventry, 1988/1989)*, Lecture Notes in Math., vol. 1462, Springer, Berlin, 1991, pp. 42–62.
- [3] BERGER (P.) – *Persistence des stratifications de laminations normalement dilatées*, PhD Thesis, Université Paris XI (2007).
- [4] ———, *Persistent bundles over a two dimensional compact set*, ArXiv e-prints (2009).
- [5] ———, *Persistence of laminations*, Bull Braz Math Soc, New series, t. **41(2)** (2010), pp. 259–319.
- [6] ———, *Persistence des sous variétés à bord et à coins*, Ann. Inst. Fourier, t. **61(1)** (2011), pp. 79–104.
- [7] BERGER (P.) & ROVELLA (A.) – *On the inverse limit stability of endomorphisms*, to appear in Ann. Inst. H. Poincaré (C) Non Linear Analysis; <http://arxiv.org/abs/1006.4302>.
- [8] BONATTI (CHRISTIAN), DÍAZ (LORENZO J.) & VIANA (MARCELO) – *Dynamics beyond uniform hyperbolicity*, Encyclopaedia of Mathematical Sciences, vol. 102, Springer-Verlag, Berlin, 2005, A global geometric and probabilistic perspective, Mathematical Physics, III.
- [9] BUZZI (JÉRÔME), SESTER (OLIVIER) & TSUJII (MASATO) – *Weakly expanding skew-products of quadratic maps*, Ergodic Theory Dynam. Systems, t. **23** (2003), no. 5, pp. 1401–1414.

- [10] CERF (JEAN) – *Topologie de certains espaces de plongements*, Bull. Soc. Math. France, t. **89** (1961), pp. 227–380.
- [11] DOUADY (ADRIEN) – *Variétés à bord anguleux et voisinages tubulaires*, in *Séminaire Henri Cartan, 1961/62, Exp. 1*, Secrétariat mathématique, Paris, 1961/1962, pp. 11.
- [12] GHYS (ÉTIENNE) – *Laminations par surfaces de Riemann*, in *Dynamique et géométrie complexes (Lyon, 1997)*, Panor. Synthèses, vol. 8, Soc. Math. France, Paris, 1999, pp. ix, xi, 49–95.
- [13] GOURMELON (NIKOLAZ) – *Adapted metrics for dominated splittings*, Ergodic Theory Dynam. Systems, t. **27** (2007), no. 6, pp. 1839–1849.
- [14] GRACZYK (JACEK) & ŚWIĄTEK (GRZEGORZ) – *The real Fatou conjecture*, Annals of Mathematics Studies, vol. 144, Princeton University Press, Princeton, NJ, 1998.
- [15] HIRSCH (M. W.), PUGH (C. C.) & SHUB (M.) – *Invariant manifolds*, Springer-Verlag, Berlin, 1977, Lecture Notes in Mathematics, Vol. 583.
- [16] HIRSCH (MORRIS W.) – *Differential topology*, Springer-Verlag, New York, 1976, Graduate Texts in Mathematics, No. 33.
- [17] KARCHER (H.) – *Riemannian center of mass and mollifier smoothing*, Comm. Pure Appl. Math., t. **30** (1977), no. 5, pp. 509–541.
- [18] LYUBICH (MIKHAIL) – *Dynamics of quadratic polynomials. I, II*, Acta Math., t. **178** (1997), no. 2, pp. 185–247, 247–297.
- [19] MAÑÉ (RICARDO) – *Persistent manifolds are normally hyperbolic*, Trans. Amer. Math. Soc., t. **246** (1978), pp. 261–283.
- [20] ———, *A proof of the C^1 stability conjecture*, Inst. Hautes Études Sci. Publ. Math. (1988), no. 66, pp. 161–210.
- [21] MATHER (JOHN N.) – *Stratifications and mappings*, in *Dynamical systems (Proc. Sympos., Univ. Bahia, Salvador, 1971)*, Academic Press, New York, 1973, pp. 195–232.
- [22] DE MELO (W.) – *Structural stability of diffeomorphisms on two-manifolds*, Invent. Math., t. **21** (1973), pp. 233–246.
- [23] MICHOR (PETER W.) – *Manifolds of differentiable mappings*, Shiva Mathematics Series, vol. 3, Shiva Publishing Ltd., Nantwich, 1980.
- [24] MILNOR (JOHN) – *Dynamics in one complex variable*, third ed., Annals of Mathematics Studies, vol. 160, Princeton University Press, Princeton, NJ, 2006.

- [25] MUROLO (CLAUDIO) & TROTMAN (DAVID) – *Semidifférentiabilité et version lisse de la conjecture de fibration de Whitney*, *Advanced Studies in Pure Mathematics* (2006), no. 43, pp. 271–309.
- [26] PALIS (J.) & SMALE (S.) – *Structural stability theorems*, in *Global Analysis (Proc. Sympos. Pure Math., Vol. XIV, Berkeley, Calif., 1968)*, Amer. Math. Soc., Providence, R.I., 1970, pp. 223–231.
- [27] ROBBIN (J.W.) – *A structural stability theorem*, *Ann. of Math. (2)*, t. **94** (1971), pp. 447–493.
- [28] ROBINSON (CLARK) – *Structural stability of C^1 diffeomorphisms*, *J. Differential Equations*, t. **22** (1976), no. 1, pp. 28–73.
- [29] RODRIGUEZ HERTZ (FEDERICO), RODRIGUEZ HERTZ (MARIA ALEJANDRA) & URES (RAUL) – *A survey of partially hyperbolic dynamics, in Partially hyperbolic dynamics, laminations, and Teichmüller flow*, *Fields Inst. Commun.*, vol. 51, Amer. Math. Soc., Providence, RI, 2007, pp. 35–87.
- [30] SHUB (MICHAEL) – *Endomorphisms of compact differentiable manifolds*, *Amer. J. Math.*, t. **91** (1969), pp. 175–199.
- [31] ———, *Stabilité globale des systèmes dynamiques*, *Astérisque*, vol. 56, Société Mathématique de France, Paris, 1978, With an English preface and summary.
- [32] SMALE (S.) – *Differentiable dynamical systems*, *Bull. Amer. Math. Soc.*, t. **73** (1967), pp. 747–817.
- [33] THOM (R.) – *Local topological properties of differentiable mappings*, in *Differential Analysis, Bombay Colloq.*, Oxford Univ. Press, London, 1964, pp. 191–202.
- [34] TROTMAN (DAVID J. A.) – *Geometric versions of Whitney regularity for smooth stratifications*, *Ann. Sci. École Norm. Sup. (4)*, t. **12** (1979), no. 4, pp. 453–463.
- [35] VIANA (MARCELO) – *Multidimensional nonhyperbolic attractors*, *Inst. Hautes Études Sci. Publ. Math.* (1997), no. 85, pp. 63–96.
- [36] WHITNEY (HASSLER) – *Local properties of analytic varieties*, in *Differential and Combinatorial Topology (A Symposium in Honor of Marston Morse)*, Princeton Univ. Press, Princeton, N. J., 1965, pp. 205–244.
- [37] ———, *Tangents to an analytic variety*, *Ann. of Math. (2)*, t. **81** (1965), pp. 496–549.
- [38] YOCOZO (JEAN-CHRISTOPHE) – *Introduction to hyperbolic dynamics*, in *Real and complex dynamical systems (Hillerød, 1993)*, NATO Adv. Sci. Inst. Ser. C Math. Phys. Sci., vol. 464, Kluwer Acad. Publ., Dordrecht, 1995, pp. 265–291.