



ANNALES DE L'INSTITUT FOURIER

Hülya ARGÜZ & Pierrick BOUSSEAU

**Real Log Curves in Toric Varieties, Tropical Curves, and Log
Welschinger Invariants**

Tome 72, n° 4 (2022), p. 1547-1620.

<https://doi.org/10.5802/aif.3507>

Article mis à disposition par ses auteurs selon les termes de la licence
CREATIVE COMMONS ATTRIBUTION – PAS DE MODIFICATION 3.0 FRANCE



<http://creativecommons.org/licenses/by-nd/3.0/fr/>



Les *Annales de l'Institut Fourier* sont membres du
Centre Mersenne pour l'édition scientifique ouverte
www.centre-mersenne.org e-ISSN : 1777-5310

REAL LOG CURVES IN TORIC VARIETIES, TROPICAL CURVES, AND LOG WELSCHINGER INVARIANTS

by Hülya ARGÜZ & Pierrick BOUSSEAU (*)

ABSTRACT. — We give a tropical description of the counting of real log curves in toric degenerations of toric varieties. We treat the case of genus zero curves and all non-superabundant higher-genus situations. The proof relies on log deformation theory and is a real version of the Nishinou–Siebert approach to the tropical correspondence theorem for complex curves. In dimension two, we use similar techniques to study the counting of real log curves with Welschinger signs and we obtain a new proof of Mikhalkin’s tropical correspondence theorem for Welschinger invariants.

RÉSUMÉ. — Nous donnons une description tropicale du comptage des log-courbes réelles dans les dégénérescences toriques de variétés toriques. Nous traitons le cas des courbes de genre zéro et toutes les situations non-superabondantes pour les courbes de genre supérieur. La preuve repose sur la théorie des déformations logarithmiques et est une version réelle de l’approche par Nishinou–Siebert du théorème de correspondance tropicale pour les courbes complexes. En dimension deux, nous utilisons des techniques similaires pour étudier le comptage de log-courbes réelles avec signes de Welschinger et nous obtenons une nouvelle preuve du théorème de correspondance tropicale de Mikhalkin pour les invariants de Welschinger.

1. Introduction

1.1. Overview

Tropical geometry provides a combinatorial approach to complex and real enumerative geometry. Using a version of Viro’s patchworking [45, 46,

Keywords: log Gromov–Witten invariants, Welschinger invariants, toric varieties, tropical geometry, real geometry.

2020 *Mathematics Subject Classification:* 14T05, 14N10, 14N35, 14P99.

(*) During the preparation of this paper the first author has received funding from the European Research Council (ERC) under the European Unions Horizon 2020 research and innovation programme (grant agreement No. 682603), and from Fondation Mathématique Jacques Hadamard.

The second author acknowledges the support of Dr. Max Rössler, the Walter Haefner Foundation and the ETH Zurich Foundation.

47], Mikhalkin [32, Theorem 1] proved a correspondence theorem between counts of complex curves in toric surfaces and counts of tropical curves in \mathbb{R}^2 . In [34], Nishinou–Siebert used toric degenerations and log deformation theory to prove a correspondence theorem between counts of genus 0 complex curves in n -dimensional toric varieties and counts of tropical curves in \mathbb{R}^n . Under the assumption of non-superabundacy, this result was generalized by Nishinou [33] to higher-genus complex curves. Further works on the tropical correspondence theorem for complex curves in toric varieties include [18, 31, 36, 43].

In the present paper, we focus on counts of real curves in toric varieties. We start by recalling the main difference between complex and real algebraic geometry. In complex geometry, a space of configurations in general position is typically connected, as configurations which are not in general position form loci of complex codimension at least one and so of real codimension at least two. For example, counts of complex curves matching incidence conditions in general position are independent of the particular choice of general incidence conditions. By contrast, in real geometry, a space of configurations in general position is typically disconnected, as configurations which are not in general position typically form loci of real codimension one. It follows that counts of real curves matching incidence conditions in general positions depend in general of the particular choice of general incidence condition.

Therefore, a correspondence theorem between counts of tropical curves and counts of real curves in a toric variety matching some real incidence conditions can only hold in general for a specific class of incidence conditions, those which are in some sense close to some “tropical limit”. In [32, Theorem 3], Mikhalkin proved such a result for real curves in toric surfaces passing through configurations of real points. Our main result, Theorem 1.1, generalizes this result to genus 0 and higher-genus non-superabundant real curves in higher dimensional toric varieties, in complete analogy with how Nishinou–Siebert [34] generalized Mikhalkin’s correspondence theorem [32, Theorem 1] for complex curves. More precisely, we consider a toric degeneration of a toric variety and of a set of incidence conditions. Theorem 1.1 describes how to compute tropically counts of real curves matching the incidence conditions in a fiber of the toric degeneration which is sufficiently close to the central fiber. It is in this precise sense that we are restricting ourselves to incidence conditions close to a “tropical limit”.

In [32, Theorem 6], Mikhalkin also proved a tropical correspondence theorem for real curves in toric surfaces counted with Welschinger signs,

that is with the sign $(-1)^s$ where s is the number of real elliptic nodes of the curve. Using the techniques developed to prove Theorem 1.1, we will give a new proof of this result, see Theorem 1.2. In restriction to the case of rational curves in del Pezzo toric surfaces, counts with Welschinger signs are Welschinger invariants [49, 50] and have the remarkable property of being invariant with respect to deformation of incidence conditions. The tropical correspondence theorem [32, Theorem 6] has been a central tool in the study of Welschinger invariants [9, 10, 23, 24, 25].

1.2. Main results

We now state precisely our first main result, Theorem 1.1, referring to the main body of the paper for more details on the objects involved.

Let $M = \mathbb{Z}^n$ and $M_{\mathbb{R}} = M \otimes_{\mathbb{Z}} \mathbb{R}$. Let X be a n -dimensional proper toric variety over \mathbb{C} , defined by a complete fan Σ in $M_{\mathbb{R}}$. Remark that every toric variety over \mathbb{C} is naturally defined over \mathbb{Z} and so in particular over \mathbb{R} . We fix a tuple $(g, \Delta, \mathbf{A}, \mathbf{P})$ where:

- g is a nonnegative integer.
- Δ is a map $\Delta : M \setminus \{0\} \rightarrow \mathbb{N}$ with support contained in the union of rays of Σ . The choice of Δ specifies a degree and tangency conditions along the toric divisors for a curve in X , and a tropical degree for a tropical curve in $M_{\mathbb{R}}$. We denote by $|\Delta|$ the number of $v \in M \setminus \{0\}$ with $\Delta(v) \neq 0$, that is the number of contact points with the toric boundary divisor (union of toric divisors) for a corresponding algebraic curve, or the number of unbounded edges for a corresponding tropical curve.
- $\mathbf{A} = (A_1, \dots, A_{\ell})$ is a tuple of affine linear subspaces A_j of $M_{\mathbb{Q}} = M \otimes_{\mathbb{Z}} \mathbb{Q}$ with codimension $d_j + 1$ such that

$$(1.1) \quad \sum_{j=1}^{\ell} d_j = (n - 3)(1 - g) + |\Delta|.$$

We denote by $L(A_j) \subset M_{\mathbb{Q}}$ the linear direction of A_j .

- $\mathbf{P} = (P_1, \dots, P_{\ell})$ is a tuple of real points in the n -dimensional torus of X .

Let $\mathfrak{T}_{g,\ell,\Delta}(\mathbf{A})$ be the set of ℓ -marked tropical curves $h: \Gamma \rightarrow M_{\mathbb{R}}$ of genus g and degree Δ and matching the tropical incidence conditions \mathbf{A} . We assume that we are in a non-superabundant situation, that is that the set $\mathfrak{T}_{g,\ell,\Delta}(\mathbf{A})$ consists of finitely many tropical curves $h: \Gamma \rightarrow M_{\mathbb{R}}$, all with

Γ trivalent, and which are all non-superabundant, that is having a space of deformations of the expected dimension $(n - 3)(1 - g) + |\Delta|$. Such non-superabundant condition is automatic if $g = 0$ by [34, Proposition 2.4] or if $n = 2$ by [32, Proposition 4.11].

As in [34], we construct a toric degeneration $\pi: \mathcal{X} \rightarrow \mathbb{A}^1$ from a polyhedral decomposition of $M_{\mathbb{R}}$ containing the images of all the tropical curves in $\mathfrak{T}_{g,\ell,\Delta}(\mathbf{A})$ and all their intersection points with the tropical constraints \mathbf{A} . For $t \in \mathbb{A}^1 \setminus \{0\}$, we have $X_t := \pi^{-1}(t) \simeq X$. The central fiber $X_0 := \pi^{-1}(0)$ is a union of toric varieties glued along their toric divisors. Using \mathbf{A} and \mathbf{P} , we construct a family of real incidence conditions $\mathcal{Z}_{A_j, P_j} \subset \mathcal{X}$. For every $t \in \mathbb{A}^1$, we denote $Z_{A_j, P_j, t} := \mathcal{Z}_{A_j, P_j} \cap X_t \subset X_t$ (see (2.5)–(2.6) for details).

For every $t \in \mathbb{A}^1(\mathbb{R}) \setminus \{0\} \simeq \mathbb{R}^\times$, let $M_{(g,\Delta,\mathbf{A},\mathbf{P}),t}^{\mathbb{R}\text{-log}}$ be the set of genus g real stable map to X_t with degree and tangency conditions along the toric divisors prescribed by Δ and matching the incidence conditions $\mathbf{Z}_{\mathbf{A},\mathbf{P},t}$. We denote

$$N_{(g,\Delta,\mathbf{A},\mathbf{P}),t}^{\mathbb{R}\text{-log}} := \#M_{(g,\Delta,\mathbf{A},\mathbf{P}),t}^{\mathbb{R}\text{-log}}.$$

In our main result, Theorem 1.1, we explain how to tropically compute $N_{(g,\Delta,\mathbf{A},\mathbf{P}),t}^{\mathbb{R}\text{-log}}$ for t sufficiently close to 0.

We define the real count of tropical curves by an explicit formula

$$(1.2) \quad N_{(g,\Delta,\mathbf{A},\mathbf{P})}^{\mathbb{R}\text{-trop}} := \sum_{(\Gamma, \mathbf{E}, h) \in \mathfrak{T}_{g,\ell,\Delta}(\mathbf{A})} w^{\mathbb{R}}(\Gamma, \mathbf{E}) \cdot \mathcal{D}_{\mathcal{T}_h, \sigma}^{\mathbb{R}} \cdot \prod_{j=1}^{\ell} \mathcal{D}_{\mathcal{A}_j}^{\mathbb{R}}.$$

We refer to the main body of the paper for the definition of the various factors: $w^{\mathbb{R}}(\Gamma, \mathbf{E})$ is the total real weight defined in (5.1), $\mathcal{D}_{\mathcal{T}, \sigma}^{\mathbb{R}}$ is the twisted real lattice index of the map \mathcal{T}_h given by (4.2), and $\mathcal{D}_{\mathcal{A}_i}^{\mathbb{R}}$ is the real lattice index of the inclusion of lattices \mathcal{A}_i defined in (4.10), the real lattice index being defined in Definition 4.12 and the twisted real lattice index being defined in Theorem 4.15.

THEOREM 1.1 (=Theorem 7.1). — *For every $(g, \Delta, \mathbf{A}, \mathbf{P})$ as above, we have*

$$N_{(g,\Delta,\mathbf{A},\mathbf{P}),t}^{\mathbb{R}\text{-log}} = N_{(g,\Delta,\mathbf{A},\mathbf{P})}^{\mathbb{R}\text{-trop}}$$

for all $t \in \mathbb{A}^1(\mathbb{R}) \setminus \{0\} \simeq \mathbb{R}^\times$ sufficiently close to 0.

The proof of Theorem 1.1 follows the lines of the proof of the main result of [34]. In a first step, given a tropical curve (Γ, \mathbf{E}, h) in $\mathfrak{T}_{g,\ell,\Delta}(\mathbf{A})$, we count how many ways there are to lift (Γ, \mathbf{E}, h) into a maximally degenerate real stable map to the central fiber X_0 . In [34], the count of such maximally degenerate complex stable maps is expressed as the index of a map of lattices $\mathcal{T}_h: M_1 \rightarrow M_2$. The lattice index, that is the cardinality

of $\text{Coker}(\mathcal{T}_h)$, is also the cardinality of the kernel of the map of complex tori $\mathcal{T}_h \otimes \mathbb{C}^\times : M_1 \otimes_{\mathbb{Z}} \mathbb{C}^\times \rightarrow M_2 \otimes_{\mathbb{Z}} \mathbb{C}^\times$. In the proof of [34], the map $\mathcal{T}_h \otimes \mathbb{C}^\times$ measures the obstruction to construct a maximally degenerate stable map by gluing of its irreducible components living inside the various toric components of X_0 . So the kernel of $\mathcal{T}_h \otimes \mathbb{C}^\times$ is exactly in bijection with the relevant complex maximally degenerate stable maps. In the real case, we show similarly that the set of relevant maximally degenerate real stable maps can be identified with the kernel of the map of real tori $\mathcal{T}_h \otimes \mathbb{R}^\times : M_1 \otimes_{\mathbb{Z}} \mathbb{R}^\times \rightarrow M_2 \otimes_{\mathbb{Z}} \mathbb{R}^\times$. By some elementary homological algebra (see Lemma 4.13), the cardinality of the kernel of $\mathcal{T}_h \otimes \mathbb{R}^\times$ can be computed in terms of a cyclic decomposition of the group $\text{Coker}(\mathcal{T}_h)$. Modulo the issue that $\mathcal{T}_h \otimes \mathbb{R}^\times$ is not necessarily surjective (see Theorem 4.15 for details), this gives the definition of the factor $\mathcal{D}_{\mathcal{T}_h, \sigma}^{\mathbb{R}}$ in (1.2).

In a second step, we need to count how many ways there are to lift a maximally degenerate real stable map to X_0 into a real stable log map to X_0 . This is done in Theorem 5.1 and this produces the factor $w^{\mathbb{R}}(\Gamma, \mathbf{E})$ in (1.2). Finally, the counting of real stable log maps to the central fiber X_0 agrees with the counting of real stable log maps on a neighbour fiber X_t by log smooth deformation theory, as in [34].

We remark that for $n = 2$, Mikhalkin [32, Theorem 3] gives an alternative recursive description of $N_{(g, \Delta, \mathbf{A}, \mathbf{P})}^{\mathbb{R}\text{-trop}}$. This is similar to how Mikhalkin [32, Theorem 1] expresses the complex multiplicity of a tropical curve as a product of local multiplicities attached to vertices, whereas the complex multiplicity of Nishinou–Siebert [34] is a priori a globally defined lattice index. We also remark that, for $g = 0$, a version of Theorem 1.1 is proved by Tyomkin in [44, Section 5.1]. Tyomkin’s proof uses explicit rational parametrizations of rational curves in toric varieties and so is fundamentally limited to the $g = 0$ case. Thus, one can view Theorem 1.1 as providing a common generalization of [32, Theorem 3] and [44, Section 5.1]. Finally, we point out that, while we prove Theorem 1.1 via a real version of the log arguments of Nishinou–Siebert [34], it should also be possible to write a proof using a real version of the stacky approach to the correspondence theorem due to Tyomkin in [43].

Our second main result, Theorem 1.2, is a tropical correspondence theorem for counts of real curves with Welschinger signs in toric surfaces, recovering with a different proof [32, Theorem 6] (see also [37]). We stay in the setup of Theorem 1.1 but specialized to $n = 2$ and to the case of 0-dimensional affine constraints \mathbf{A} .

For $t \in \mathbb{A}^1(\mathbb{R}) \setminus \{0\} \simeq \mathbb{R}^\times$ general, all the singularities of the image $\varphi(C)$ of a real stable map $\varphi: C \rightarrow X_t$ defining an element of $M_{(g,\Delta,\mathbf{A},\mathbf{P}),t}^{\mathbb{R}\text{-log}}$ are nodes, that is ordinary double points. The Welschinger sign of φ is defined by

$$\mathcal{W}^{\text{log}}(\varphi) := (-1)^{m(\varphi)}$$

where $m(\varphi)$ is the number of real elliptic nodes of $\varphi(C)$. We define log Welschinger numbers by

$$\mathcal{W}_{(g,\Delta,\mathbf{A},\mathbf{P}),t}^{\mathbb{R}\text{-log}} := \sum_{\varphi \in M_{(g,\Delta,\mathbf{A},\mathbf{P}),t}^{\mathbb{R}\text{-log}}} \mathcal{W}^{\text{log}}(\varphi).$$

In Theorem 1.2, we explain how to tropically compute $\mathcal{W}_{(g,\Delta,\mathbf{A},\mathbf{P}),t}^{\mathbb{R}\text{-log}}$ for t sufficiently close to 0.

Let $h: \Gamma \rightarrow M_{\mathbb{R}}$ be a tropical curve defining an element of $\mathcal{T}_{g,\ell,\Delta}(\mathbf{A})$. For V a vertex of Γ , let $\Delta_V \subset N_{\mathbb{R}}$ denote the dual triangle to V : for every edge E_i of Γ adjacent to V , the corresponding side of Δ_V has integral length equal to the weight $w(E_i)$ of E_i . We set

$$\text{Mult}_{\mathbb{R}}(V) := (-1)^{I_{\Delta_V}},$$

where I_{Δ_V} is the number of integral points in the interior of Δ_V . We define the multiplicity of a tropical curve by

$$(1.3) \quad \text{Mult}_{\mathbb{R}}(h) := \begin{cases} 0 & \text{if } \Gamma \text{ contains a bounded edge of even weight} \\ \prod_V \text{Mult}_{\mathbb{R}}(V) & \text{else.} \end{cases}$$

Finally, we define

$$\mathcal{W}_{(g,\Delta,\mathbf{A},\mathbf{P})}^{\mathbb{R}\text{-trop}} := \sum_{(\Gamma,\mathbf{E},h) \in \mathcal{T}_{g,\ell,\Delta}(\mathbf{A})} \text{Mult}_{\mathbb{R}}(h).$$

THEOREM 1.2 (=Theorem 9.8). — *For all $t \in \mathbb{A}^1(\mathbb{R}) \setminus \{0\} \simeq \mathbb{R}^\times$ sufficiently close to 0, we have*

$$(1.4) \quad \mathcal{W}_{(g,\Delta,\mathbf{A},\mathbf{P}),t}^{\mathbb{R}\text{-log}} = \mathcal{W}_{(g,\Delta,\mathbf{A},\mathbf{P})}^{\mathbb{R}\text{-trop}}.$$

Theorem 1.2 recovers [32, Theorem 6], proved by Mikhalkin using degeneration of the complex structure and a version of Viro’s patchworking. A purely algebraic proof is also given by Shustin in [37] (see also the exposition given in [27]). Our proof of Theorem 1.2 relies on the log geometric framework used in the proof of Theorem 1.1, and as such differs from the proofs given by [32] and [37]. Nevertheless, we will use one of the key idea of [37], described in [37] as a refinement of the tropicalization by a shift operation, and reinterpreted in our language as a non-toric blow-up of the

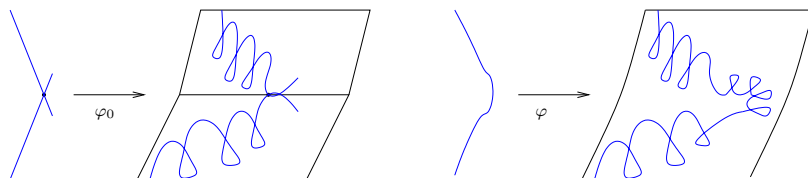

Figure 1.1. A maximally degenerate real log curve $\varphi_0: C_0 \rightarrow X_0$ and its deformation $\varphi: C \rightarrow X$ with some new nodes generated in the image.

central fiber X_0 (see also [39, 40]). In deforming a real stable log map $\varphi_0: C_0 \rightarrow X_0$ to the central fiber X_0 into a real stable log map $\varphi: C \rightarrow X_t$, the nodes of $\varphi_0(C_0)$ away from the double locus of X_0 deform into locally isomorphic nodes of $\varphi(C)$, but the nodes of $\varphi_0(C_0)$ on the double locus of X_0 deform in general into several nodes of $\varphi(C)$, see Figure 1.1. We perform a non-toric blow-up of X_0 in order to study the real nature of these nodes.

For X a toric del Pezzo surface and $d \in H_2(X, \mathbb{Z})$ such that $c_1(X) \cdot d - 1 > 0$, let $\Delta_d: M \setminus \{0\} \rightarrow \mathbb{N}$ be the tropical degree defined by $\Delta_d(v) = d \cdot D_v$ if v is the primitive generator of the ray of the fan of X corresponding to the toric divisor D_v , and $\Delta_d(v) = 0$ else. Then, for $g = 0$ and $\Delta = \Delta_d$, the log Welschinger number $\mathcal{W}_{(0, \Delta_d, \mathbf{A}, \mathbf{P}), t}^{\text{R-log}}$ agrees with the Welschinger invariant defined symplectically in [49, 50], see Corollary 9.11. In particular, it follows from [49, 50] that $\mathcal{W}_{(0, \Delta_d, \mathbf{A}, \mathbf{P}), t}^{\text{R-log}}$ is independent of t in this case.

1.3. Future directions

In [34], Nishinou–Siebert stressed in the complex case the robustness of the log geometric framework. This has been remarkably confirmed by the development of log Gromov–Witten theory [1, 22]. In the present paper, we make a first step in the study of real stable log maps. We mention briefly possible future directions to test the robustness of the real log geometric framework.

We are considering “purely real” constraints: our incidence conditions are isomorphic to toric varieties with their standard real structures. It would be interesting to study pairs of complex conjugated constraints. For real toric del Pezzo surfaces, Shustin [38] (see also [14]) has given a tropical description of Welschinger invariants for real curves passing through arbitrary real configuration of points (real and complex conjugated pairs).

One should be able to apply degeneration techniques to non-toric situations. A natural plan is to start with the study of non-toric log Calabi–Yau surfaces: we expect the formulation of a real version of the tropical vertex of Gross–Pandharipande–Siebert [20], compatible with its q -deformed version [8, 12], and with possible applications to a real version of mirror symmetry and to real Gromov–Witten invariants (see for example [7, Conjecture 6.2.1]).

Finally, a natural question is the tropical interpretation of higher-dimensional versions of Welschinger invariants. Welschinger [51, 52] defined 3-dimensional invariants, later generalized by Solomon [41, 42] in the setting of open Gromov–Witten theory. For \mathbb{P}^3 , an interpretation in terms of floor diagrams appears in [9]. We also refer to Georgieva–Zinger for positive-genus analogues of Welschinger’s invariants for several real symplectic manifolds, such as the odd-dimensional projective spaces and the quintic threefold [15, 16, 17]. It is natural to ask if real log geometric techniques can shed some light on these invariants in a more general setup. This will be the focus of future work.

1.4. Plan of the paper

In Section 2, we review the construction of toric degenerations and basic facts on tropical curves in \mathbb{R}^n . In Section 3, we introduce the notion of real stable log map. In Section 4, we prove Theorem 4.15 counting ways to lift a tropical curve to a maximally degenerate real stable map to the central fiber X_0 . In Section 5, we prove Theorem 5.1 counting ways to lift a maximally degenerate real stable to X_0 to a real stable log map. In Section 6, we use log deformation theory to study deformation of a real stable log map to X_0 in a real stable log map to a neighbour fiber X_t . In Section 7, we prove our main result, Theorem 7.1 (=Theorem 1.1) by combining the results proved in Sections 4–6. In Section 8, we discuss the counting of tropical curves in \mathbb{R}^2 with Welschinger signs. In Section 9, we prove Theorem 9.8 (=Theorem 1.2) computing tropically the counts of real stable log maps in toric surfaces with Welschinger signs. We conclude Section 9 by a discussion of the relation with the symplectically defined Welschinger invariants.

1.5. Acknowledgements

We thank Mark Gross, Bernd Siebert, Eugenio Shustin, Ilya Tyomkin, Tom Coates, Ilia Itenberg and Dimitri Zvonkine for useful discussions. A

major part of this paper was written during our visit to Kyoto University for the 5th KTGU Mathematics Workshop for Young Researchers. We thank Hiroshi Iritani and all the other organisers for their hospitality. Finally, we thank the anonymous referee for their careful reading and the many suggestions to improve the exposition.

2. Tropical curves and toric degenerations

In this section, we review basic facts about tropical curves and toric degenerations, mainly following [34, Sections 1–3].

2.1. Tropical curves in \mathbb{R}^n

Throughout this paper we fix the lattice $M = \mathbb{Z}^n$ and we denote by $M_{\mathbb{R}} = M \otimes_{\mathbb{Z}} \mathbb{R}$ the associated n -dimensional real vector space.

Let $\bar{\Gamma}$ be a weighted, connected finite graph without divalent vertices. Denote the set of vertices and edges of $\bar{\Gamma}$ by $\bar{\Gamma}^{[0]}$ and $\bar{\Gamma}^{[1]}$ respectively, and let

$$w_{\bar{\Gamma}} : \bar{\Gamma}^{[1]} \rightarrow \mathbb{N} \setminus \{0\}$$

be the weight function. Denote the set of adjacent vertices to an edge $E \in \bar{\Gamma}^{[1]}$ by $\partial E = \{V_1, V_2\}$. The set of 1-valent vertices is denoted by $\bar{\Gamma}_{\infty}^{[0]} \subseteq \bar{\Gamma}^{[0]}$. We set

$$\Gamma = \bar{\Gamma} \setminus \bar{\Gamma}_{\infty}^{[0]}.$$

We denote the set of vertices and edges of Γ as $\Gamma^{[0]}$, $\Gamma^{[1]}$, and let

$$w_{\Gamma} : \Gamma^{[1]} \rightarrow \mathbb{N} \setminus \{0\}$$

be the restriction of the weight function to $\Gamma^{[1]}$. We call the non-compact edges of Γ *unbounded edges* and denote the set of unbounded edges by $\Gamma_{\infty}^{[1]} \subseteq \Gamma^{[1]}$. We call the compact edges of Γ *bounded edges*. The set of bounded edges of Γ is $\Gamma^{[1]} \setminus \Gamma_{\infty}^{[1]}$.

DEFINITION 2.1. — *A parameterized tropical curve in $M_{\mathbb{R}}$ is a proper map $h : \Gamma \rightarrow M_{\mathbb{R}}$ satisfying the following conditions.*

- (1) *For every edge $E \subseteq \Gamma^{[1]}$, the restriction $h|_E$ is an embedding with image $h(E)$ contained in an affine line with rational slope.*

(2) For every vertex $V \in \Gamma^{[0]}$, the following balancing condition holds.

Let

$$E_1, \dots, E_m \in \Gamma^{[1]}$$

be the edges adjacent to V , and let $m_i \in M$ be the primitive integral vector emanating from $h(V)$ in the direction of $h(E_i)$. Then

$$(2.1) \quad \sum_{j=1}^m w_\Gamma(E_j) m_j = 0.$$

An isomorphism of parametrized tropical curves $h: \Gamma \rightarrow N_\mathbb{R}$ and $h': \Gamma' \rightarrow M_\mathbb{R}$ is a homeomorphism $\Phi: \Gamma \rightarrow \Gamma'$ respecting the weights of the edges and such that $h = h' \circ \Phi$. A tropical curve is an isomorphism class of parameterized tropical curves. The genus of a tropical curve $h: \Gamma \rightarrow M_\mathbb{R}$ is the first Betti number of Γ .

Let

$$F(\Gamma) = \{(V, E) \mid E \in \Gamma^{[1]} \text{ and } V \in \partial E\}$$

be the set of flags of Γ . Let

$$\begin{aligned} u: F(\Gamma) &\longrightarrow M \\ F(\Gamma) \ni (V, E) &\longmapsto u_{V,E} \end{aligned}$$

be the map sending a flag (V, E) to the primitive integral vector $u_{(V,E)} \in M$ emanating from $h(V)$ in the direction of $h(E)$.

DEFINITION 2.2. — The type of a tropical curve $h: \Gamma \rightarrow M_\mathbb{R}$ is the pair (Γ, u) .

DEFINITION 2.3. — The degree of a type (Γ, u) of tropical curves is the map

$$\Delta(\Gamma, u): M \setminus \{0\} \longrightarrow \mathbb{N}$$

defined by

$$\Delta(\Gamma, u)(v) := \#\{(V, E) \in F(\Gamma) \mid E \in \Gamma_\infty^{[1]}, w(E) \cdot u_{(V,E)} = v\}.$$

The degree of a tropical curve is the degree of its type.

For every $\Delta: M \setminus \{0\} \rightarrow \mathbb{N}$ with finite support, we define

$$(2.2) \quad |\Delta| := \sum_{v \in M \setminus \{0\}} \Delta(v).$$

Note that a tropical curve of degree Δ has $|\Delta|$ unbounded edges.

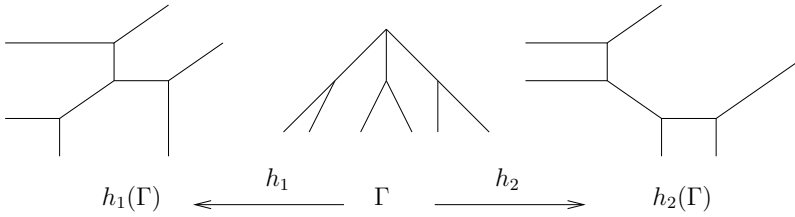

Figure 2.1. Two tropical curves $h_1 : \Gamma \rightarrow \mathbb{R}^2$ and $h_2 : \Gamma \rightarrow \mathbb{R}^2$ having different types but the same degree.

DEFINITION 2.4. — An ℓ -marked tropical curve (Γ, \mathbf{E}, h) consists of a tropical curve $h : \Gamma \rightarrow M_{\mathbb{R}}$ together with a choice of ℓ edges

$$\mathbf{E} = (E_1, \dots, E_\ell) \subset (\Gamma^{(1)})^\ell .$$

For a given type (Γ, u) of degree Δ , we denote by $\mathfrak{T}_{(\Gamma, u)}$ the set of isomorphism classes of marked tropical curves of type (Γ, u) . If Γ trivalent of genus g , then, by [32, Proposition 2.13] (see also [19, Proposition 1.17]), $\mathfrak{T}_{(\Gamma, u)}$ is an open convex polyhedral domain in a real affine space of dimension greater or equal to $(n - 3)(1 - g) + |\Delta|$.

Example 2.5. — For (Γ, u) the type of either one of the two tropical curves in Figure 2.1, we have $\mathfrak{T}_{(\Gamma, u)} = \mathbb{R}^2 \times (\mathbb{R}_{>0})^3$, where the first factor \mathbb{R}^2 is the position of one of the vertices and the three factors $\mathbb{R}_{>0}$ are the lengths of the three bounded edges. Note that in this example, we have $n = 2, g = 0, |\Delta| = 6$, so $(n - 3)(1 - g) + |\Delta| = 5$.

DEFINITION 2.6. — Let (Γ, u) be a type of tropical curves of degree Δ with Γ trivalent and of genus g . We say that (Γ, u) is non-superabundant if

$$\dim \mathfrak{T}_{(\Gamma, u)} = (n - 3)(1 - g) + |\Delta| .$$

A (marked) tropical curve is non-superabundant if its type is non-superabundant.

Example 2.7. — A tropical curve $h : \Gamma \rightarrow M_{\mathbb{R}}$ is superabundant if some of the cycles of Γ map into smaller-dimensional affine-linear subspaces of $M_{\mathbb{R}}$, as illustrated in Figure 2.2. For a more comprehensive discussion on super-abundancy we refer to [32, Section 2.6].

DEFINITION 2.8. — An affine constraint is an ℓ -tuple $\mathbf{A} = (A_1, \dots, A_\ell)$ of affine subspaces $A_j \subset M_{\mathbb{Q}}$. An ℓ -marked tropical curve (Γ, \mathbf{E}, h) matches the affine constraint \mathbf{A} if

$$h(E_j) \cap A_j \neq \emptyset \quad \text{for all } j = 1, \dots, \ell .$$

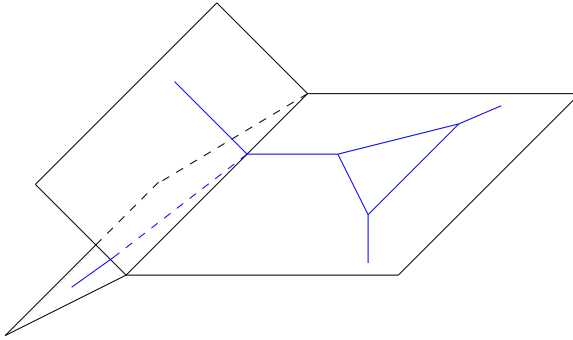

Figure 2.2. Image of a non-superabundant tropical curve $h : \Gamma \rightarrow \mathbb{R}^3$.

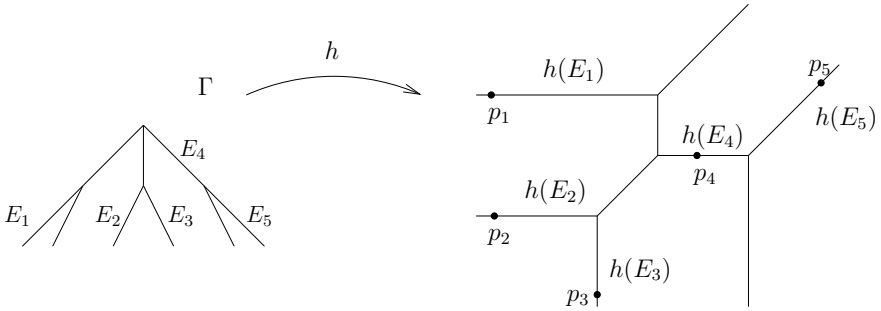

Figure 2.3. A marked tropical curve matching 5 points in \mathbb{R}^2 .

Example 2.9. — In Figure 2.3 we illustrate a marked tropical curve (Γ, \mathbf{E}, h) , with $\mathbf{E} = (E_1, \dots, E_5)$, matching an affine constraint given by 5 points (p_1, \dots, p_5) .

DEFINITION 2.10. — For $g \in \mathbb{N}$ and $\Delta : M \setminus \{0\} \rightarrow \mathbb{N}$, the set of ℓ -marked tropical curves of genus g and degree Δ is denoted $\mathfrak{T}_{g,\ell,\Delta}$. We denote by $\mathfrak{T}_{g,\ell,\Delta}(\mathbf{A})$ the subset of tropical curves matching an affine constraint \mathbf{A} .

DEFINITION 2.11. — Let $g \in \mathbb{N}$ and $\Delta : M \setminus \{0\} \rightarrow \mathbb{N}$ with finite support. An affine constraint $\mathbf{A} = (A_1, \dots, A_\ell)$ is general for (g, Δ) if:

- writing $\text{codim } A_j = d_j + 1$, we have

$$\sum_{j=1}^{\ell} d_j = (n - 3)(1 - g) + |\Delta|;$$

- no translation of $M_{\mathbb{R}}$ preserves $\bigcup_{j=1}^{\ell} A_j$, that is, there does not exist $v \in M_{\mathbb{R}}$ such that $\bigcup_{j=1}^{\ell} A_j + \mathbb{R}v \subset \bigcup_{j=1}^{\ell} A_j$;
- for any ℓ -marked tropical curve (Γ, \mathbf{E}, h) of genus g , degree Δ , and matching \mathbf{A} , the following hold:
 - Γ is trivalent;
 - (Γ, \mathbf{E}, h) is non-superabundant;
 - $h(\Gamma^{[0]}) \cap \bigcup_{j=1}^{\ell} A_j = \emptyset$;
 - h is injective for $n > 2$. For $n = 2$, it is at least injective on the subset of vertices, and all fibers are finite.

PROPOSITION 2.12 ([32, Proposition 4.11], [34, Proposition 2.4]). — Let $g \in \mathbb{N}$, $\Delta: M \setminus \{0\} \rightarrow \mathbb{N}$ with finite support, and $\mathbf{A} = (A_1, \dots, A_{\ell})$ an affine constraint such that, writing $\text{codim } A_j = d_j + 1$, we have

$$\sum_{j=1}^{\ell} d_j = (n - 3)(1 - g) + |\Delta|.$$

Denote by $\mathfrak{A} := \prod_{j=1}^{\ell} M_{\mathbb{Q}}/L(A_j)$ the space of affine constraints that are parallel to \mathbf{A} , where $L(A_j) \subset M_{\mathbb{Q}}$ is the linear subspace associated to the affine subspace A_j . Assume that $n = 2$ or $g = 0$. Then the subset

$$\mathfrak{A} := \{\mathbf{A}' \in \mathfrak{A} \mid \mathbf{A}' \text{ is nongeneral for } (g, \Delta)\}$$

of \mathfrak{A} is nowhere dense.

Proof. — For $n = 2$, this is Proposition 4.11 of [32]. For $g = 0$, this is Proposition 2.4 of [34]. □

PROPOSITION 2.13. — Let $g \in \mathbb{N}$, $\Delta: M \setminus \{0\} \rightarrow \mathbb{N}$ with finite support, and \mathbf{A} an affine constraint general for (g, Δ) . Then the set $\mathfrak{T}_{g,\ell,\Delta}(\mathbf{A})$ of ℓ -marked tropical curves of genus g and degree Δ matching \mathbf{A} is finite.

Proof. — By [34, Proposition 2.1], there are only finitely many types of tropical curves of genus g and degree Δ . The set of marked tropical curves of a given non-superabundant type is a convex polyhedron P in $\mathbb{R}^{(n-3)(1-g)+|\Delta|}$. The set of marked tropical curves of this type matching \mathbf{A} is the intersection of P with some affine subspace Q of $\mathbb{R}^{(n-3)(1-g)+|\Delta|}$. If Q intersects the boundary of P in $\mathbb{R}^{(n-3)(1-g)+|\Delta|}$, then the tropical curve is not trivalent and this contradicts the assumption that \mathbf{A} is general. Therefore, the intersection of $Q \cap P$ is entirely contained in P , and so is an affine subspace entirely contained in P . If $Q \cap P$ is not zero-dimensional, this is only possible if $Q \cap P$ contains a one-dimensional family of translated tropical curves, which again contradicts the assumption that \mathbf{A} is general

(more precisely that no translation preserves $\bigcup_{j=1}^{\ell} A_j$). Hence $Q \cap P$ is zero-dimensional, and so is either empty or consists of a single point. \square

2.2. Toric degenerations of toric varieties from polyhedral decompositions

In this section we review how to produce from a polyhedral decomposition of $M_{\mathbb{Q}}$ a toric degeneration over \mathbb{C} . For details we refer to [34, Section 3].

DEFINITION 2.14. — *A polyhedral decomposition of $M_{\mathbb{Q}}$ is a covering $\mathcal{P} = \{\Xi\}$ of $M_{\mathbb{Q}}$ by a finite number of strongly convex polyhedra satisfying the following two properties:*

- (i) *If $\Xi \in \mathcal{P}$ and $\Xi' \subset \Xi$ is a face, then $\Xi' \in \mathcal{P}$.*
- (ii) *If $\Xi, \Xi' \in \mathcal{P}$, then $\Xi \cap \Xi'$ is a common face of Ξ and Ξ' .*

Let \mathcal{P} be a polyhedral decomposition $M_{\mathbb{Q}}$. We will denote by $\mathcal{P}^{[k]}$ the set of k -dimensional cells of \mathcal{P} . For each $\Xi \in \mathcal{P}$, let $C(\Xi)$ be the closure of the cone spanned by $\Xi \times \{1\}$ in $M_{\mathbb{R}} \times \mathbb{R}$:

$$(2.3) \quad C(\Xi) = \overline{\{a \cdot (n, 1) \mid a \geq 0, n \in \Xi\}}.$$

Note that taking the closure here will be important while talking about the asymptotic cone in cases Ξ is unbounded. We use the convex polyhedral cones $C(\Xi)$ to define a fan presented by its faces as

$$\tilde{\Sigma}_{\mathcal{P}} := \{\sigma \subset C(\Xi) \text{ face} \mid \Xi \in \mathcal{P}\}$$

which we refer to as the fan associated to \mathcal{P} . By construction, the projection onto the second factor

$$M_{\mathbb{R}} \times \mathbb{R} \longrightarrow (M_{\mathbb{R}} \times \mathbb{R}) / M_{\mathbb{R}} = \mathbb{R}$$

defines a non-constant map of fans from the fan $\tilde{\Sigma}_{\mathcal{P}}$ to the fan $\{0, \mathbb{R}_{\geq 0}\}$ of \mathbb{A}^1 , hence a flat toric morphism

$$\pi: \mathcal{X} \longrightarrow \mathbb{A}^1,$$

where \mathcal{X} is the $(n + 1)$ -dimensional toric variety over \mathbb{C} defined by the fan $\tilde{\Sigma}_{\mathcal{P}}$. Throughout this paper we will say that $\pi: \mathcal{X} \rightarrow \mathbb{A}^1$ is the toric degeneration obtained from the polyhedral decomposition \mathcal{P} of $M_{\mathbb{Q}}$.

Note that $\pi: \mathcal{X} \rightarrow \mathbb{A}^1$ is a degeneration of toric varieties. To describe the general fiber of π , we first identify $M_{\mathbb{R}}$ with $M_{\mathbb{R}} \times \{0\} \subset M_{\mathbb{R}} \times \mathbb{R}$ and we define the fan

$$\Sigma_{\mathcal{P}} = \{\sigma \cap (M_{\mathbb{R}} \times \{0\}) \mid \sigma \in \tilde{\Sigma}_{\mathcal{P}}\}.$$

By Lemma 3.3 in [34], $\Sigma_{\mathcal{P}}$ is the asymptotic fan of the polyhedral decomposition \mathcal{P} . Let X be the n -dimensional toric variety over \mathbb{C} defined by the fan $\Sigma_{\mathcal{P}}$. By Lemma 3.4 of [34] we have

$$\pi^{-1}(\mathbb{A}^1 \setminus \{0\}) = X \times (\mathbb{A}^1 \setminus \{0\})$$

and the closed fibers of π over $\mathbb{A}^1 \setminus \{0\}$ are all pairwise isomorphic to X .

We now describe the central fiber

$$X_0 := \pi^{-1}(0).$$

For $\Xi \in \mathcal{P}$ the rays emanating from Ξ through adjacent $\Xi' \in \mathcal{P}$ define a fan Σ_{Ξ} by

$$(2.4) \quad \Sigma_{\Xi} = \{ \mathbb{R}_{\geq 0} \cdot (\Xi' - \Xi) \subset M_{\mathbb{R}}/L(\Xi) \mid \Xi' \in \mathcal{P}, \Xi \subset \Xi' \}.$$

in $M_{\mathbb{R}}/L(\Xi)$, where $L(\Xi) \subset M_{\mathbb{R}}$ is the linear subspace associated to Ξ . Let X_{Ξ} be the toric variety over \mathbb{C} associated to the fan Σ_{Ξ} . By Proposition 3.5 in [34], there exist closed embeddings $X_{\Xi} \hookrightarrow X_0$, $\Xi \in \mathcal{P}$ compatible with morphisms $X_{\Xi} \rightarrow X_{\Xi'}$ for $\Xi' \subset \Xi$, inducing an isomorphism

$$X_0 \simeq \varinjlim_{\Xi \in \mathcal{P}} X_{\Xi}.$$

In particular, the central fiber X_0 is a union of toric varieties, glued along toric boundary divisors.

Example 2.15. — The polyhedral decomposition \mathcal{P} illustrated in Figure 2.4 defines a toric degeneration of the toric variety \mathbb{P}^2 , whose associated fan is the asymptotic fan $\Sigma_{\mathcal{P}}$, into the union of the 7 copies of \mathbb{P}^2 and a copy of $\mathbb{P}^1 \times \mathbb{P}^1$. The neighbourhoods of vertices of \mathcal{P} , labelled by red circles in the figure, correspond to the fans of the 7 irreducible components of the central fiber.

2.3. Degeneration of incidence conditions

In the remaining of the paper, we will study curves in toric degenerations $\pi: \mathcal{X} \rightarrow \mathbb{A}^1$ matching some incidence conditions. We now explain how to construct these incidence conditions.

Let A be an affine subspace of $M_{\mathbb{Q}}$ and let P be a point in the $(n + 1)$ -dimensional torus orbit of \mathcal{X} . Denoting $LC(A)$ the linear closure of $A \times \{1\}$ in $M_{\mathbb{Q}} \times \mathbb{Q}$, we introduce the closure in \mathcal{X} of the orbit of the torus $(LC(A) \cap (M \times \mathbb{Z})) \otimes_{\mathbb{Z}} \mathbb{C}^{\times}$ passing through the point P :

$$(2.5) \quad \mathcal{Z}_{A,P} := \overline{((LC(A) \cap (M \times \mathbb{Z})) \otimes_{\mathbb{Z}} \mathbb{C}^{\times}) \cdot P} \subset \mathcal{X}.$$

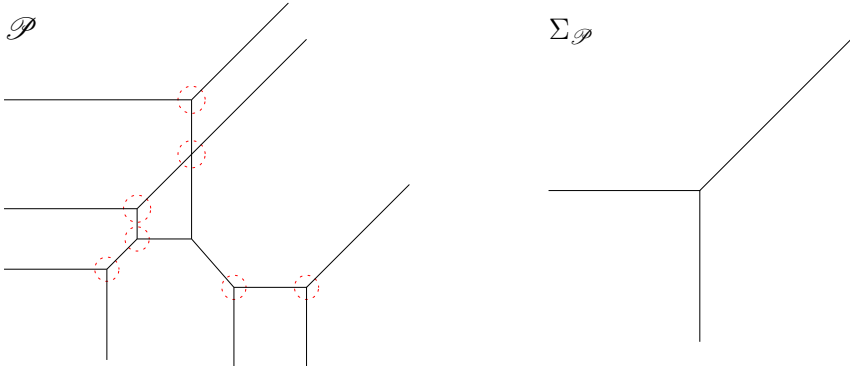

Figure 2.4. A polyhedral decomposition \mathcal{P} of $M_{\mathbb{Q}}$ and the associated asymptotic fan $\Sigma_{\mathcal{P}}$.

For every $t \in \mathbb{A}^1$, we define

$$(2.6) \quad Z_{A,P,t} := \mathcal{Z}_{A,P} \cap X_t,$$

the intersection of $\mathcal{Z}_{A,P}$ with the fiber $X_t := \pi^{-1}(t)$. In particular, $Z_{A,P,0}$ is a subvariety of the central fiber X_0 .

2.4. Good polyhedral decompositions

DEFINITION 2.16. — Let $g \in \mathbb{N}$, $\Delta: M \setminus \{0\} \rightarrow \mathbb{N}$ with finite support, and $\mathbf{A} = (A_1, \dots, A_\ell)$ an affine constraint that is general for (g, Δ) . Let \mathcal{P} be an integral polyhedral decomposition of $M_{\mathbb{Q}}$ such that, for every $(\Gamma, \mathbf{E}, h) \in \mathfrak{T}_{g,\ell,\Delta}(\mathbf{A})$, we have the following.

- (i) The image $h(\Gamma)$ is contained in the one-skeleton of \mathcal{P} , that is, $h(\Gamma^{[0]}) \subset \bigcup_{\Xi \in \mathcal{P}^{[0]}} \Xi$ and $h(\Gamma^{[1]}) \subset \bigcup_{\Xi \in \mathcal{P}^{[1]}} \Xi$.
- (ii) Intersection points of $h(\Gamma)$ with the constraints are vertices of \mathcal{P} : $h(\Gamma) \cap A_j \subset \mathcal{P}^{[0]}$ for every $j = 1, \dots, \ell$.
- (iii) For every bounded edge $E \in \Gamma^{[1]}$, the weight $w(E)$ divides the integral affine length of $h(E)$.

Then, we say \mathcal{P} is a polyhedral decomposition good for (g, Δ, \mathbf{A}) .

PROPOSITION 2.17. — Let $g \in \mathbb{N}$, $\Delta: M \setminus \{0\} \rightarrow \mathbb{N}$ with finite support, and $\mathbf{A} = (A_1, \dots, A_\ell)$ an affine constraint that is general for (g, Δ) . Up to a rescaling of $M \subset M_{\mathbb{Q}}$, there exists a polyhedral decomposition of $M_{\mathbb{Q}}$ which is good for (g, Δ, \mathbf{A}) .

Proof. — By Proposition 2.13, the set $\mathfrak{T}_{g,\ell,\Delta}(\mathbf{A})$ is finite. Therefore the result follows from part (1) of the proof of Theorem 8.3 of [34] (which relies on [34, Proposition 3.9]). \square

3. Real stable log maps

Log geometry is an efficient tool to work systematically with normal crossings divisors in algebraic geometry, and so to deal with many questions involving degenerations and compactifications. In this paper, extending the work of [34] considering complex curves, we use log geometry to study real curves in special fibers of toric degenerations and their deformations.

Throughout this section we assume basic familiarity with log geometry [30, 35]. For an introductory review see [6]. Nevertheless, we start reviewing a couple of definitions to fix our notation. Then, we introduce real stable log maps.

3.1. Log schemes

All the monoids in this paper are assumed to be commutative.

DEFINITION 3.1. — *Let X be a scheme. A pre log structure on X is a sheaf of monoids \mathcal{M} on X together with a homomorphism of monoids $\alpha: \mathcal{M} \rightarrow \mathcal{O}_X$ where we consider the structure sheaf \mathcal{O}_X as a monoid with respect to multiplication. A pre log structure on X is called a log structure if α induces an isomorphism*

$$\alpha|_{\alpha^{-1}(\mathcal{O}_X^\times)} : \alpha^{-1}(\mathcal{O}_X^\times) \longrightarrow \mathcal{O}_X^\times.$$

We call a scheme X endowed with a log structure a log scheme, and denote the log structure on X by $(\mathcal{M}_X, \alpha_X)$, or sometimes by omitting the structure homomorphism from the notation, just by \mathcal{M}_X . We denote a scheme X , endowed with a log structure by (X, \mathcal{M}_X) .

Let X be a log scheme. The ghost sheaf of X is the sheaf on X defined by

$$\overline{\mathcal{M}}_X := \mathcal{M}_X / \alpha^{-1}(\mathcal{O}_X^\times).$$

Example 3.2. — Let $D \subset X$ be a divisor. Let $j: X \setminus D \hookrightarrow X$ denote the inclusion map. The divisorial log structure on X is the pair $(\mathcal{M}_{(X,D)}, \alpha_X)$, where $\mathcal{M}_{(X,D)}$ is the sheaf of regular functions on X , that restrict to units on $X \setminus D$. That is,

$$\mathcal{M}_{(X,D)} := j_*(\mathcal{O}_{X \setminus D}^\times) \cap \mathcal{O}_X.$$

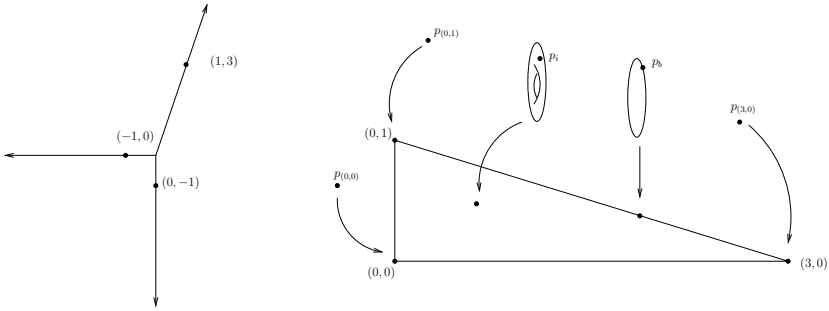

Figure 3.1. The fan $\Sigma_{\mathbb{P}(1,1,3)}$ for the toric variety $\mathbb{P}(1,1,3)$ on the left and its dual $\Delta_{\mathbb{P}(1,1,3)}$ on the right, referred to as the moment map image of $\mathbb{P}(1,1,3)$ [13, Chapter 4], along with some points labelled on different types of fibers of the moment map $\mathbb{P}(1,1,3) \rightarrow \Delta_{\mathbb{P}(1,1,3)}$.

The structure homomorphism α_X is given by the inclusion $\alpha_X : \mathcal{M}_{(X,D)} \hookrightarrow \mathcal{O}_X$.

Analogous to assigning a sheaf to a presheaf, we can assign a log structure to a pre log structure, using a fibered coproduct, as follows.

DEFINITION 3.3. — Let $\alpha : \mathcal{P} \rightarrow \mathcal{O}_X$ be a prelog structure on X . We define the log structure associated to the prelog structure (\mathcal{P}, α) on X as follows. Set

$$\mathcal{P}^a := \mathcal{P} \oplus \mathcal{O}_X^\times / \{(p, \alpha(p)^{-1}) \mid p \in \alpha^{-1}(\mathcal{O}_X^\times)\}$$

and define the structure homomorphism $\alpha^a : \mathcal{P}^a \rightarrow \mathcal{O}_X$ by

$$\alpha^a(p, h) = h \cdot \alpha(p).$$

One can easily check that $(\mathcal{P}^a, \alpha^a)$ is a log structure on X .

Let Y be a log scheme, and let $f : X \rightarrow Y$ be a scheme theoretic morphism. Then, the log structure on Y , given by $\alpha_Y : \mathcal{M}_Y \rightarrow \mathcal{O}_Y$, induces a log structure on X defined as follows. First define a prelog structure, by considering the composition

$$f^{-1}\mathcal{M}_Y \longrightarrow f^{-1}\mathcal{O}_Y \longrightarrow \mathcal{O}_X.$$

Then, we endow X with the log structure associated to this prelog structure, as in Definition 3.3. We refer to this log structure as the *pull back log structure* or the *induced log structure* on X , and denote it by $\mathcal{M}_X = f^*\mathcal{M}_Y$.

Example 3.4. — For every scheme X , $\mathcal{M}_X := \mathcal{O}_X^\times$ define a log structure on X , called the *trivial log structure*. In particular, taking $X = \text{Spec } \mathbb{C}$, we call $(\text{Spec } \mathbb{C}, \mathbb{C}^\times)$ the *trivial log point*.

Example 3.5. — Let $X := \text{Spec } \mathbb{C}$. Define $\mathcal{M}_X := \mathbb{C}^\times \oplus \mathbb{N}$, and $\alpha_X : \mathcal{M}_X \rightarrow \mathbb{C}$ as follows.

$$\alpha_X(x, n) := \begin{cases} x & \text{if } n = 0 \\ 0 & \text{if } n \neq 0. \end{cases}$$

The corresponding log scheme $O_0 := (\text{Spec } \mathbb{C}, \mathbb{C}^\times \oplus \mathbb{N})$ is called the *standard log point*. One can check that the log structure on the standard log point is the same as the pull-back of the divisorial log structure on \mathbb{A}^1 with the divisor $D = \{0\} \subset \mathbb{A}^1$.

DEFINITION 3.6. — *A log structure \mathcal{M} on a scheme X is called coherent if étale locally on X there exists a finitely generated monoid \mathcal{P} and, denoting \mathcal{P}_X the constant sheaf corresponding to \mathcal{P} , a prelog structure $\mathcal{P}_X \rightarrow \mathcal{O}_X$ whose associated log structure, defined as in Definition 3.3, is isomorphic to \mathcal{M} . Recall that a monoid \mathcal{P} is called integral if the canonical map $\mathcal{P} \rightarrow \mathcal{P}^{\text{gp}}$ from \mathcal{P} to its Grothendieck group \mathcal{P}^{gp} is injective. The sheaf \mathcal{M} is called integral if \mathcal{M} is a sheaf of integral monoids. If \mathcal{M} is both coherent and integral then it is called fine.*

DEFINITION 3.7. — *For a scheme X with a fine log structure \mathcal{M} a chart for \mathcal{M} is a homomorphism $\mathcal{P}_X \rightarrow \mathcal{M}$ for a finitely generated integral monoid \mathcal{P} which induces $\mathcal{P}^a \cong \mathcal{M}$ over an étale open subset of X .*

Remark 3.8. — Let X be a toric variety defined by a fan Σ in $N_{\mathbb{R}}$. The *toric log structure* on X is the divisorial log structure $\mathcal{M}_X = \mathcal{M}_{(X,D)}$ defined by the toric boundary divisor $D \subset X$, that is, the union of toric divisors of X . Moreover this log structure is fine. Note that for any $\sigma \in \Sigma$, and recalling that $N := \text{Hom}(M, \mathbb{Z})$, we have the affine toric subset

$$U_\sigma = \text{Spec } \mathbb{C}[\sigma^\vee \cap N]$$

of X , where σ^\vee is the dual cone of σ , and the divisorial log structure \mathcal{M}_X is locally generated by the monomial functions on this open subset. That is, the canonical map

$$(3.1) \quad \begin{aligned} \sigma^\vee \cap N &\longrightarrow \mathbb{C}[\sigma^\vee \cap N] \\ n &\longmapsto z^n \end{aligned}$$

is a chart for the log structure on U_σ .

PROPOSITION 3.9. — *For any point x in the interior of the toric stratum of X associated to σ , the toric chart (3.1) induces a canonical isomorphism*

$$\sigma^\vee \cap N / \sigma^\perp \cap N \xrightarrow{\sigma} \overline{\mathcal{M}}_{X,x} .$$

Proof. — The proof is straightforward and can be found in [4, Proposition A.30]. □

Example 3.10. — Consider the weighted projective plane

$$X = \mathbb{P}_{(1,1,3)} = (\mathbb{C}^3 \setminus \{0\}) / \mathbb{C}^* ,$$

where the action of \mathbb{C}^* is given by $\xi \cdot (x_0, x_1, x_2) = (\xi x_0, \xi x_1, \xi^3 x_2)$, with associated toric fan and moment image $\Delta_{\mathbb{P}_{(1,1,3)}}$ as in Figure 3.1. Recall that $\mathbb{P}_{(1,1,3)}$ admits a torus fibration onto $\Delta_{\mathbb{P}_{(1,1,3)}}$, with fibers illustrated on the right hand side of the figure. We describe below the toric log structure locally around points on different types of fibers. Let $D = D_1 \cup D_2 \cup D_3$ be the toric boundary divisor. Denote by \mathcal{M}_X be the toric log structure as in Remark 3.8, given by the sheaf of regular functions which are units in $X \setminus D$.

For a point p_i contained in the 2-dimensional torus orbit of $\mathbb{P}_{(1,1,3)}$, that is, whose image under the moment map maps to the interior of $\Delta_{\mathbb{P}_{(1,1,3)}}$, the stalk of \mathcal{M}_X is generated by functions that are all units on $X \setminus D$. Hence, the stalk of the ghost sheaf at such a point is trivial; $\overline{\mathcal{M}}_{X,p_i} = 0$. Let p_b be a generic point in $D \subset \mathbb{P}_{(1,1,3)}$. Then the image of p_b under the moment map lies in the boundary of $\Delta_{\mathbb{P}_{(1,1,3)}}$. The stalk of \mathcal{M}_X is generated by functions which are of the form $h \cdot x^a$, where $a \in \mathbb{N}$, h is a unit on $X \setminus D$, and the local equation of D in a neighbourhood of p_b is given by $(x = 0)$. Then, the stalk of the ghost sheaf is

$$\begin{aligned} \overline{\mathcal{M}}_{X,p_b} &\cong \mathbb{N} \\ x^a &\mapsto a . \end{aligned}$$

Note that one can describe the stalk at such points $p_b \in D_i \subset D$, for $i = 1, 2, 3$, as the integral points on the dual of the ray in Σ corresponding to the divisor D_i . Similarly, for the two smooth torus fixed points $p_{(0,0)}$ and $p_{(3,0)}$, we have $\overline{\mathcal{M}}_{X,p_{(0,0)}} = \overline{\mathcal{M}}_{X,p_{(3,0)}} = \mathbb{N}^2$. Finally, for the singular torus fixed point $p_{(0,1)}$, the stalk of the ghost sheaf $\overline{\mathcal{M}}_{X,p_{(0,1)}}$ is the monoid of integral points contained in the dual cone σ^\vee of the cone σ spanned by $(-1, 0)$ and $(1, 3)$ in the fan.

Let $\pi: \mathcal{X} \rightarrow \mathbb{A}^1 = \text{Spec } \mathbb{C}[t]$ be a toric degeneration of toric varieties as in Section 2.2. The total space \mathcal{X} is toric and so can be endowed with the

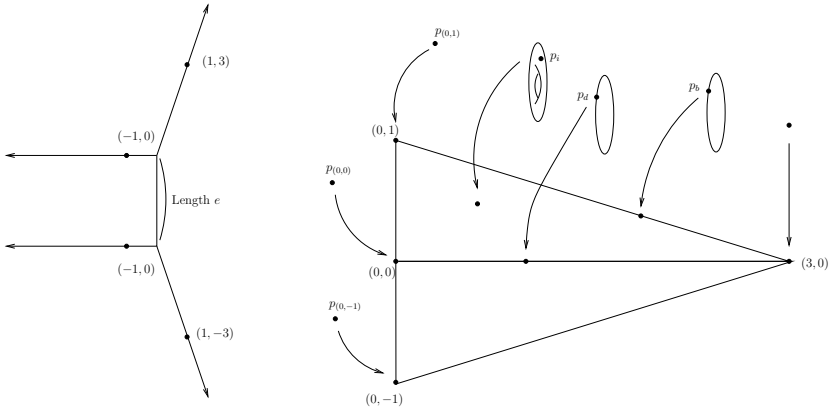

Figure 3.2. A polyhedral decomposition and the moment map of the central fiber of the associated toric degeneration.

divisorial toric log structure $\mathcal{M}_{\mathcal{X}}$. We endow the central fiber $X_0 \subset \mathcal{X}$ with the pull-back log structure

$$(3.2) \quad \mathcal{M}_{X_0} = \iota^* \mathcal{M}_{\mathcal{X}}$$

induced from \mathcal{X} by the inclusion $\iota: X_0 \hookrightarrow \mathcal{X}$. Note that the toric affine cover of \mathcal{X} induces an affine cover of the central fiber X_0 by restriction to $t = 0$, and this defines a chart for the log structure \mathcal{M}_{X_0} .

Example 3.11. — In Figure 3.2, we illustrate on the left a polyhedral decomposition of \mathbb{R}^2 and on the right the moment map of the central fiber X_0 of the associated toric degeneration \mathcal{X} as in Section 2.2. The central fiber X_0 has two irreducible components, both isomorphic to the weighted projective plane $\mathbb{P}_{(1,1,3)}$ (see Example 3.10). We endow X_0 with the pullback log structure (3.2) \mathcal{M}_{X_0} . For p_i a point contained in the 2-dimensional torus orbit of one of the two irreducible components, we have $\overline{\mathcal{M}}_{X_0, p_i} = \mathbb{N}$. From the point of view of the degeneration $\pi: \mathcal{X} \rightarrow \mathbb{A}^1 = \text{Spec } \mathbb{C}[t]$, $\overline{\mathcal{M}}_{X_0, p_i} = \overline{\mathcal{M}}_{\mathcal{X}, p_i} = \mathbb{N}$ is generated by t^n , $n \in \mathbb{N}$. Note that the restriction of the log structure on X_0 to the toric components is not the toric log structure such as described in Example 3.10: the ghost sheaf of the toric log structure is generically trivial, whereas the ghost sheaf of the log structure restricted from X_0 is generically \mathbb{N} . A more general comparison of these two log structures can be found in [21, Lemma 5.13].

For a point p_d in the double locus of X_0 , we have $\overline{\mathcal{M}}_{X_0, p_d} = S_e := \mathbb{N}^2 \oplus_{\mathbb{N}} \mathbb{N}$, where e is the integral length of the bounded vertical edge of the polyhedral decomposition, and where in the fibered coproduct $\mathbb{N}^2 \oplus_{\mathbb{N}} \mathbb{N}$

one uses the maps $\mathbb{N} \rightarrow \mathbb{N}^2, 1 \mapsto (1, 1)$, and $\mathbb{N} \rightarrow \mathbb{N}, 1 \mapsto e$. Transversally to the double locus, the log structure near p_d is locally isomorphic to the restriction over $t = 0$ of the toric log structure on the toric surface of equation $zw = t^e$, whose algebra of regular functions is exactly the monoid algebra of the monoid S_e .

DEFINITION 3.12. — A morphism of log schemes $f: (X, \mathcal{M}_X) \rightarrow (Y, \mathcal{M}_Y)$ is a morphism of schemes $f: X \rightarrow Y$ along with a homomorphism of sheaves of monoids $f^\sharp: f^{-1}\mathcal{M}_Y \rightarrow \mathcal{M}_X$ such that the diagram

$$\begin{array}{ccc} f^{-1}\mathcal{M}_Y & \xrightarrow{f^\sharp} & \mathcal{M}_X \\ \alpha_Y \downarrow & & \downarrow \alpha_X \\ f^{-1}\mathcal{O}_Y & \xrightarrow{f^*} & \mathcal{O}_X \end{array}$$

is commutative. Here, f^* is the usual pull-back of regular functions defined by the morphism f . Given a morphism of log spaces $f : (X, \mathcal{M}_X) \rightarrow (Y, \mathcal{M}_Y)$, we denote by $\underline{f}: X \rightarrow Y$ the underlying morphism of schemes. By abuse of notation, the underlying morphism on topological spaces is also denoted by \underline{f} .

DEFINITION 3.13. — Let $f: (X, \mathcal{M}_X) \rightarrow (Y, \mathcal{M}_Y)$ be a log morphism and let x be a point of X . We say that f is strict at the point x if f^\sharp induces an isomorphism $f^{-1}\mathcal{M}_{Y,f(p)} \simeq \mathcal{M}_{X,p}$.

We refer to [19, Definition 3.23] for the notion of log smooth morphism. We recall that a toric variety is log smooth over the trivial log point. If $\pi: \mathcal{X} \rightarrow \mathbb{A}^1$ is a toric degeneration of toric varieties, then π can be naturally viewed as a log smooth morphism. In restriction to $t = 0$, we get a log smooth morphism $X_0 \rightarrow O_0$, that is, X_0 is log smooth over the standard log point O_0 . We also refer to [19, Remark 3.25] for the notion of integral morphism of log schemes.

3.2. Stable log maps

We recall that a ℓ -marked stable map with target a scheme X is a map $f: C \rightarrow X$, where C is a proper nodal curve with ℓ marked smooth points $\mathbf{x} = (x_1, \dots, x_\ell)$, such that the group of automorphisms of C fixing \mathbf{x} and commuting with f is finite.

The notion of stable map has a natural generalization to the setting of logarithmic geometry [1, 2, 22].

DEFINITION 3.14. — Let $X \rightarrow B$ be a log morphism between log schemes. A ℓ -marked stable log map with target $X \rightarrow B$ is a commutative diagram of log schemes

$$\begin{array}{ccc} C & \xrightarrow{f} & X \\ \pi \downarrow & & \downarrow \\ W & \longrightarrow & B, \end{array}$$

together with a tuple of sections $\mathbf{x} = (x_1, \dots, x_\ell)$ of π , where π is a proper log smooth and integral morphism of log schemes, such that, for every geometric point w of W , the restriction of f to w with the marked points $\underline{\mathbf{x}}(w)$ is an ordinary stable map, and such that, if $U \subset C$ is the non-critical locus of π , we have $\overline{\mathcal{M}}_{C|U} \simeq \pi^* \overline{\mathcal{M}}_W \oplus \bigoplus_{j=1}^\ell (x_j)_* \mathbb{N}_W$.

Remark 3.15. — When the scheme underlying W in Definition 3.14 is a point, then W is a log point $(\text{Spec } \mathbb{C}, \mathbb{C}^* \oplus Q)$, defined as the standard log point $O_0 = (\text{Spec } \mathbb{C}, \mathbb{C}^* \oplus \mathbb{N})$ as in Example 3.5, but with \mathbb{N} replaced by a possibly more complicated monoid Q . The general enumerative theory of stable log maps, called log Gromov–Witten theory and developed in [1, 22], is based on the notion of *basic stable log map*. For a basic stable log map over a log point $(\text{Spec } \mathbb{C}, \mathbb{C}^* \oplus Q)$, the monoid Q is the so-called *basic monoid*. The basic monoid is uniquely determined by the combinatorial type of the stable log map and has a natural tropical interpretation: the dual cone $\text{Hom}(Q, \mathbb{R}_{\geq 0})$ is the base of a universal family of tropical curves with given combinatorial type. For the present paper, we will mostly not use this general theory because we will end up with a finite list of unobstructed stable log maps over the standard log point O_0 . In particular, we will have a one-parameter smoothing log maps and there is always a distinguished morphism $O_0 \rightarrow (\text{Spec } \mathbb{C}, \mathbb{C}^* \oplus Q)$, where Q is the basic monoid, just coming from our degeneration situation. One exception is in the final step of the proof of Theorem 7.1, where we explain how a computational proof of [34] can be replaced by a conceptual argument based on the stable reduction theorem for basic stable log maps of [22].

The following result is the specialization to the case of a log smooth curve over the standard log point of the general theorem of Fumiharu Kato [29, p. 222] describing explicit local charts for a log smooth curve. We denote by $\sigma: \mathbb{N} \rightarrow \mathbb{C}^\times$ the chart on the standard log point $O_0 := (\text{Spec } \mathbb{C}, \mathbb{C}^\times \oplus \mathbb{N})$ defined by

$$\sigma(n) := \begin{cases} 1 & \text{if } n = 0 \\ 0 & \text{if } n \neq 0 \end{cases}$$

(see Example 3.5).

THEOREM 3.16 ([29, p. 222]). — *Let $\pi: C \rightarrow O_0$ be a log smooth and integral curve over the standard log point O_0 . Then, étale locally, (C, \mathcal{M}_C) is isomorphic to one of the following log schemes V over O_0 .*

(i) $\text{Spec}(\mathbb{C}[z])$ with the log structure induced by the chart

$$\mathbb{N} \longrightarrow \mathcal{O}_V, \quad q \longmapsto \pi^* \sigma(q).$$

(ii) $\text{Spec}(\mathbb{C}[z])$ with the log structure induced by the chart

$$\mathbb{N} \oplus \mathbb{N} \longrightarrow \mathcal{O}_V, \quad (a, q) \longmapsto z^a \pi^* \sigma(q).$$

(iii) $\text{Spec}(\mathbb{C}[z, w]/(zw))$ with the log structure induced by the chart

$$S_e := \mathbb{N}^2 \oplus_{\mathbb{N}} \mathbb{N} \longrightarrow \mathcal{O}_V, \quad ((a, b), q) \longmapsto z^a w^b \pi^* \sigma(q).$$

Here $\mathbb{N} \rightarrow \mathbb{N}^2$ is the diagonal embedding and $\mathbb{N} \rightarrow \mathbb{N}$, $1 \mapsto e$ is some homomorphism uniquely defined by $\pi: C \rightarrow O_0$. Moreover, $e \neq 0$.

In each case, the log morphism $\pi: C \rightarrow O_0$ is represented by the canonical maps of charts $\mathbb{N} \rightarrow \mathbb{N}$, $\mathbb{N} \rightarrow \mathbb{N} \oplus \mathbb{N}$ and $\mathbb{N} \rightarrow \mathbb{N}^2 \oplus_{\mathbb{N}} \mathbb{N}$, respectively where we identify the domain \mathbb{N} with the second factor of the image.

In Theorem 3.16, cases (i), (ii), (iii) correspond to neighbourhoods of general points, marked points and nodes of C respectively.

Remark 3.17. — Let (C, \mathcal{M}_C) be a log smooth curve over the standard log point O_0 and let p be a nodal point of C . By Theorem 3.16 (iii), the log structure of C at p is induced by a chart of the form

$$\beta: S_e = \mathbb{N}^2 \oplus_{\mathbb{N}} \mathbb{N} \longrightarrow \mathcal{O}_{C,q}$$

$$((a, b), q) \longmapsto \begin{cases} z^a w^b & \text{if } q = 0 \\ 0 & \text{if } q \neq 0. \end{cases}$$

For every $\zeta \in \mathbb{C}^\times$, this chart becomes after the change of variables $z \mapsto \zeta z$ the chart

$$\beta_\zeta: S_e = \mathbb{N}^2 \oplus_{\mathbb{N}} \mathbb{N} \longrightarrow \mathcal{O}_{C,q}$$

$$((a, b), q) \longmapsto \begin{cases} (\zeta^{-1} z^a) w^b & \text{if } q = 0 \\ 0 & \text{if } q \neq 0. \end{cases}$$

We will use the charts β_ζ in Section 5.

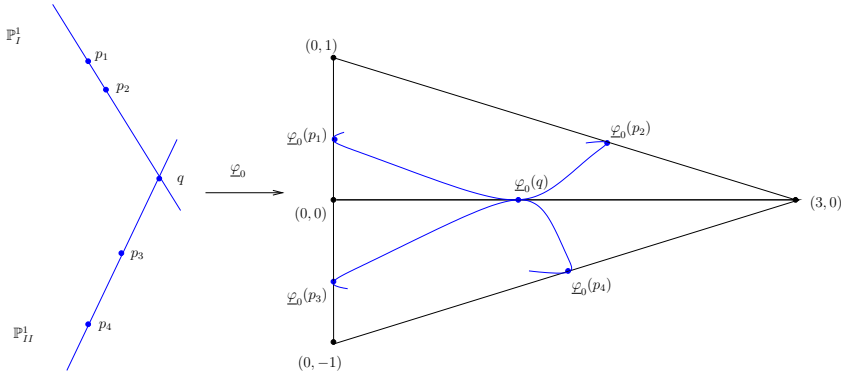

Figure 3.3. A map $\varphi_0: \mathbb{P}^1 \amalg_q \mathbb{P}^1 \rightarrow \mathbb{P}_{(1,1,3)} \amalg_{\mathbb{P}^1} \mathbb{P}_{(1,1,3)}$ from two copies of \mathbb{P}^1 glued along a nodal point q , into two copies of the weighted projective plane $\mathbb{P}_{(1,1,3)}$ glued along a copy of \mathbb{P}^1 .

Example 3.18. — In Figure 3.3, we illustrate a map φ_0 from a curve C to the central fiber X_0 of the toric degeneration considered in Example 3.11. Using the pullback log structure (3.2), X_0 is a log scheme log smooth over the standard log point O_0 . If \mathcal{M}_C is a log structure on C such that (C, \mathcal{M}_C) is log smooth over O_0 and φ_0 extends into a log morphism φ_0 , then we have $\overline{\mathcal{M}}_{C,\xi} = \mathbb{N}$ for a general point $\xi \in C$ by Theorem 3.16(i), $\overline{\mathcal{M}}_{C,p_i} = \mathbb{N} \oplus \mathbb{N}$ for a point $p_i \in C$ which maps to a divisor of X_0 not contained in the double locus by Theorem 3.16(ii), and for the node $q \in C$ we have $\overline{\mathcal{M}}_{C,q} = S_{e'}$, where the monoid $S_{e'}$ is defined analogously to S_e in Theorem 3.16(iii). Here we use $e' \in \mathbb{N}$, as $e \in \mathbb{N}$ is taken in Example 3.11 while defining the log structure on the target. In Section 5, we will give a detailed description of the set of log morphisms φ_0 with underlying morphism φ_0 at the level of schemes.

3.3. Real stable log maps

Given a scheme X over \mathbb{C} , a *real structure* on X is an anti-holomorphic involution $\iota: X \rightarrow X$ on the set of complex points of X . We call a pair (X, ι) a *real scheme*. By abuse of notation we usually omit ι when talking about real schemes. The real locus $X(\mathbb{R})$ of a real scheme (X, ι) is the set of fixed points of ι acting on the set of complex points of X .

Toric varieties are naturally defined over \mathbb{Z} : this follows directly from the explicit description of toric varieties in terms of fans. In particular,

a toric variety over \mathbb{C} is naturally defined over \mathbb{R} . We will refer to this real structure as the *standard real structure* on a toric variety. In this paper, we will always consider standard real structures on toric varieties over \mathbb{C} . If X is a n -dimensional toric variety over \mathbb{C} with its standard real structure, of fan $\Sigma \subset M$, then the intersection of the n -dimensional torus orbit $M \otimes_{\mathbb{Z}} \mathbb{C}^{\times} \simeq (\mathbb{C}^{\times})^n$ in X with the real locus $X(\mathbb{R})$ is $M \otimes_{\mathbb{Z}} \mathbb{R}^{\times} \simeq (\mathbb{R}^{\times})^n$. We refer to [13, Section 4] for more details on the real locus of toric varieties with standard real structures.

We review real structures in the setting of logarithmic algebraic geometry, as introduced in [3]. For a more comprehensive study of real log schemes, we refer to [3, Section 5].

DEFINITION 3.19. — *Let (X, \mathcal{M}_X) be a log scheme over \mathbb{C} with a real structure $\iota_X : X \rightarrow X$ on the underlying scheme. Then a real structure on (X, \mathcal{M}_X) (lifting ι_X) is an involution*

$$\tilde{\iota}_X = (\iota_X, \iota_X^{\flat}) : (X, \mathcal{M}_X) \longrightarrow (X, \mathcal{M}_X)$$

of log schemes over \mathbb{R} with underlying scheme-theoretic morphism ι_X . The data consisting of (X, \mathcal{M}_X) and the involutions ι_X, ι_X^{\flat} is called a real log scheme.

The standard real structure ι_X on a toric variety X preserves the toric divisors and so lifts by [3, Proposition 5.4] to a real structure $\tilde{\iota}_X$ on (X, \mathcal{M}_X) where \mathcal{M}_X denotes the toric log structure. We get a real log structure on the central fiber X_0 of a toric degeneration $\pi : \mathcal{X} \rightarrow \mathbb{A}^1$ by restriction of the real log structure on the toric total space \mathcal{X} . We similarly get a real log structure on the standard log point $O_0 = (\text{Spec } \mathbb{C}, \mathbb{C}^{\times} \oplus \mathbb{N})$ by restriction to $\{0\} \subset \mathbb{A}^1$ of the real log structure of \mathbb{A}^1 . The restricted real log structure makes sense due to the following result which appears as Proposition 5.9 in [3].

PROPOSITION 3.20. — *Cartesian products exist in the category of real log schemes.*

Real morphisms of real log schemes are defined as follows.

DEFINITION 3.21. — *Let (X, \mathcal{M}_X) and (Y, \mathcal{M}_Y) be real log schemes. A morphism $f : (X, \mathcal{M}_X) \rightarrow (Y, \mathcal{M}_Y)$ of real log schemes is called real if the*

following diagram is commutative.

$$\begin{array}{ccc}
 f^{-1}\iota_Y^{-1}\mathcal{M}_Y & \xrightarrow{f^{-1}\iota_Y^b} & f^{-1}\mathcal{M}_Y \\
 \iota_X^{-1}f^b \downarrow & & \downarrow f^b \\
 \iota_X^{-1}\mathcal{M}_X & \xrightarrow{\iota_X^b} & \mathcal{M}_X.
 \end{array}$$

Here the left-hand vertical arrow uses the identification $\iota_Y \circ f = f \circ \iota_X$.

Given a toric degeneration of toric varieties $\pi: \mathcal{X} \rightarrow \mathbb{A}^1$, π is naturally a real log morphism. Similarly, its restriction to the central fiber $X_0 \rightarrow O_0$ is naturally a real log morphism.

DEFINITION 3.22. — Let $X \rightarrow B$ be a real log morphism between real log schemes. A real ℓ -marked stable log map with target $X \rightarrow B$ is a commutative diagram of real log schemes

$$\begin{array}{ccc}
 C & \xrightarrow{f} & X \\
 \pi \downarrow & & \downarrow \\
 W & \longrightarrow & B,
 \end{array}$$

together with a tuple of real sections $\mathbf{x} = (x_1, \dots, x_\ell)$ of π , such that the underlying diagram and sections of log schemes over \mathbb{C} define a stable log map (in the sense of Definition 3.14).

Remark 3.23. — In Definition 3.22, we assume that the sections defining the marked points are real. This will be enough for the purposes of the present paper. A more general definition should allow pairs of complex conjugated marked points.

4. Counts of maximally degenerate real curves

In this section, we study stable maps to the central fiber X_0 of a toric degeneration. In Section 4.1, we review following [34, Section 4] pre-log stable maps to X_0 and the associated tropical curve. In Section 4.2, we introduce the notion of maximally degenerate real stable map to X_0 . In Section 4.3, we prove the main result of this section, Theorem 4.15, counting the number of ways to lift a tropical curve in $M_{\mathbb{R}}$ to a maximally degenerate real stable map to X_0 .

4.1. Pre-log stable maps and tropical curves

Following [34, Definition 4.1], we first recall the notion of torically transverse curve in a toric variety.

DEFINITION 4.1. — *Let X be a n -dimensional toric variety. An algebraic curve $C \subset X$ is called a torically transverse curve if it is disjoint from all toric strata of codimension greater than 1. A stable map $\varphi : C \rightarrow X$ over a scheme S is a torically transverse stable map if the following holds:*

- (i) *For the restriction φ_s of φ to every geometric point $s \rightarrow S$, denoting $\text{Int } X$ the n -dimensional torus orbit of X , $\varphi_s^{-1}(\text{Int } X) \subset C_s$ is dense.*
- (ii) *$\varphi_s(C_s) \subset X$ is a torically transverse curve.*

Let \mathcal{P} an integral polyhedral decomposition of $M_{\mathbb{Q}}$, and let $\pi : \mathcal{X} \rightarrow \mathbb{A}^1$ be the corresponding toric degeneration, with special fiber X_0 (see Section 2.2). The irreducible components X_v of X_0 are indexed by the vertices v of \mathcal{P} .

As in [34, Definition 4.3], we next define pre-log stable maps to X_0 . They are stable maps to X_0 obtained by gluing together torically transverse curves in the various components of X_0 which satisfy a kissing condition along the double locus of X_0 , where exactly two irreducible components of X_0 intersect.

DEFINITION 4.2. — *A stable map $\varphi_0 : C_0 \rightarrow X_0$ is called a pre-log stable map if the following holds.*

- (i) *For every v , the restriction $C_0 \times_{X_0} X_v \rightarrow X_v$ is torically transverse.*
- (ii) *If $P \in C_0$ maps to the singular locus of X_0 , then C_0 has a node at P , and φ_0 maps the two branches (C'_0, P) , (C''_0, P) of C_0 at P to different irreducible components $X_{v'}$, $X_{v''} \subset X_0$. Moreover, if w' is the intersection index with the toric boundary $D' \subset X_{v'}$ of the restriction $(C'_0, P) \rightarrow (X_{v'}, D')$, and w'' accordingly for $(C''_0, P) \rightarrow (X_{v''}, D'')$, then $w' = w''$. This condition is referred to as the kissing condition at a nodal point P .*

To every pre-log stable map φ_0 , there is an associated tropical curve $h : \Gamma \rightarrow M_{\mathbb{R}}$, contained in the one-skeleton of \mathcal{P} , and constructed as the dual intersection graph of φ_0 . The details of this construction which we summarise below can be found in [34, Construction 4.4].

CONSTRUCTION 4.3. — *Let $\varphi_0 : C_0 \rightarrow X_0$ be a pre-log stable map. We first define an open graph $\tilde{\Gamma}$. Two irreducible components of C_0 are called indistinguishable if they intersect in a node not mapping to the singular*

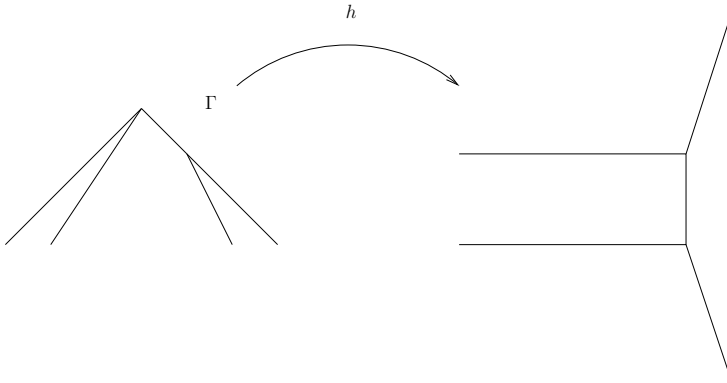

Figure 4.1. The associated tropical curve to the map φ_0 in Figure 3.3.

locus of X_0 .⁽¹⁾ Define $\tilde{\Gamma}$ to be the graph whose set of vertices equals the quotient of the set of irreducible components of C modulo identification of indistinguishable ones. Any nodal point $P_E \in C_0$ corresponds to a bounded edge E of $\tilde{\Gamma}$. To define the set of unbounded edges, first set $D \subset X_0$ to be the union of toric prime divisors of the X_v not contained in the singular locus of X_0 . Then the set of unbounded edges is $\varphi_0^{-1}(D)$. An unbounded edge E labelled by $Q_E \in \varphi_0^{-1}(D)$ attaches to $V \in \tilde{\Gamma}^{[0]}$ if $Q_E \in C_V$. Now, we define the map

$$h: \tilde{\Gamma} \longrightarrow M_{\mathbb{R}}$$

as follows. First note that by Definition 4.2, if $C_V \subset C$ denotes the irreducible component indexed by a vertex V then $h(V) = v$ for the unique $v \in \mathcal{P}^{[0]}$ with $\varphi_0(C_V) \subset X_v$. Under h a bounded edge E corresponding to a nodal point P_E maps to the line segment joining $h(V')$, $h(V'')$ if $P_E \in C_{V'} \cap C_{V''}$. To determine the images of unbounded edges of $\tilde{\Gamma}$ under h , let E be an unbounded edge labelled by $Q_E \in \varphi_0^{-1}(D)$. Assume for a 1-cell $e \in \Sigma^{[1]}$ of the toric fan of X , $D_e \subset X_{h(V)}$ is the corresponding toric divisor with $\varphi(Q_E) \subset D_e$. Then, h maps E homeomorphically to $h(V) + e \subset M_{\mathbb{Q}}$. Finally define the weights of the edges of $\tilde{\Gamma}$ adjacent to a vertex V by the intersection numbers of $\varphi_0|_{C_V}$ with the toric prime divisors of $X_{h(V)}$. This is well-defined by the definition of a pre-log stable map. While $\tilde{\Gamma}$ may have divalent vertices the kissing condition in the definition of a pre-log curve assures that the two weights at such a vertex agree. We may thus remove

⁽¹⁾In the following sections we focus attention on what we call maximally degenerate curves, which in particular have no indistinguishable components.

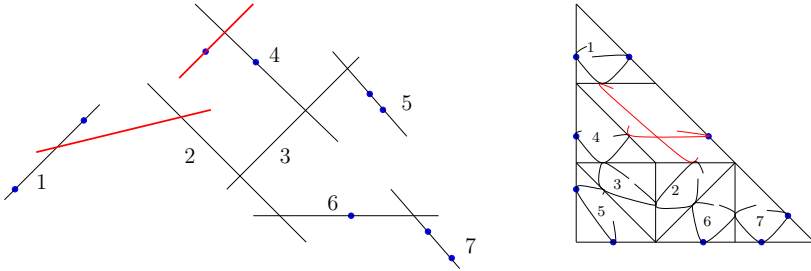

Figure 4.2. A maximally degenerate stable map $\varphi_0 : C_0 \rightarrow X_0$, where X_0 is the union of 7 copies of \mathbb{P}^2 and one copy of $\mathbb{P}^1 \times \mathbb{P}^1$, and where each irreducible component of X_0 is identified with its moment map image.

any divalent vertex and join the adjacent edges into a single edge. The resulting weighted open graph Γ has the same topological realization as $\tilde{\Gamma}$ and hence h can be interpreted as a map

$$h : \Gamma \rightarrow M_{\mathbb{Q}} .$$

Let Y be a proper toric variety and let $u_1, \dots, u_k \in M$ be the primitive generators of the rays of the toric fan of Y . If $\varphi : C \rightarrow Y$ is a torically transverse stable map, we have by [34, Proposition 4.2] that

$$(4.1) \quad \sum_{i=1}^k w_i u_i = 0 \text{ for } w_i = \deg \varphi^*(D_i)$$

the intersection number of C with the toric divisor corresponding to u_i . This result ensures that h satisfies the balancing condition (2.1) at each of its vertices, and hence is a tropical curve.

Example 4.4. — Figure 3.3 discussed in Example 3.18 represents a maximally degenerate stable map to the special fiber X_0 of the toric degeneration of Example 3.11. We illustrate in Figure 4.1 the associated tropical curve given by Construction 4.3.

Example 4.5. — In Figure 4.2, we illustrate a maximally degenerate stable map $\varphi_0 : C_0 \rightarrow X_0$ to the special fiber X_0 of the degeneration of \mathbb{P}^2 defined by the polyhedral decomposition described in Example 2.15. The special fibers X_0 is the union of 7 copies of \mathbb{P}^2 and of one copy of $\mathbb{P}^1 \times \mathbb{P}^1$. The curve C_0 has 9 irreducible components, all isomorphic to \mathbb{P}^1 . The 7 components of C_0 labeled 1 to 7 are mapped by φ_0 to the 7 copies of \mathbb{P}^2 in X_0 , whereas the two components of C_0 drawn in red are mapped to the

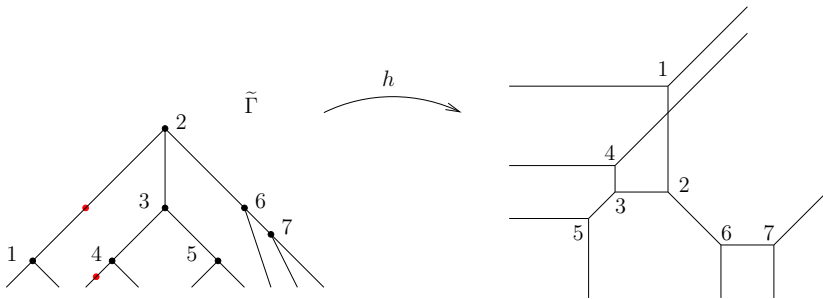

Figure 4.3. The tropical curve associated to the maximally degenerate stable map in Figure 4.2.

same component $\mathbb{P}^1 \times \mathbb{P}^1$ and their images intersect, creating a node in the image curve $\varphi_0(C_0)$ contained in the smooth locus of X_0 . The dual graph $\tilde{\Gamma}$ of C_0 constructed in Construction 4.3 is represented on the left of Figure 4.3. The graph Γ is obtained from $\tilde{\Gamma}$ by removing the two red bivalent vertices corresponding to the two red irreducible components of C_0 . Note that the image of the tropical curve $h: \tilde{\Gamma} \rightarrow M_{\mathbb{R}}$ represented on the right of Figure 4.3 is exactly the one-skeleton of the polyhedral decomposition in Figure 2.4.

4.2. Maximally degenerate real stable maps

Following [34, Definition 5.1] in the complex case, we define *real lines* and we prove some of their basic properties.

DEFINITION 4.6. — *Let X be a complete toric variety and $D \subset X$ the toric boundary, that is, the union of toric divisors of X . A line on X is a non-constant, torically transverse map $\varphi: \mathbb{P}^1 \rightarrow X$ such that for every irreducible component D_j of D , we have $\#\varphi^{-1}(D_j) \leq 1$, and there are at most 3 irreducible components D_j of D with $\#\varphi^{-1}(D_j) \neq 0$. We call a line real if φ is a real map, where both \mathbb{P}^1 and X are equipped with their standard real structure.*

Remark 4.7. — We follow Definition 5.1 of [34] for the use of the terminology “line” in Definition 4.6. However, this terminology might be misleading: one should note for example that a linear embedding of \mathbb{P}^1 in \mathbb{P}^n is not a line in the sense of Definition 4.6 if $n \geq 3$.

LEMMA 4.8. — *Let $\varphi: \mathbb{P}^1 \rightarrow X$ be a real line as in Definition 4.6. Then each intersection point of $\varphi(\mathbb{P}^1)$ with the toric boundary of X is real.*

Proof. — As $\varphi: \mathbb{P}^1 \rightarrow X$ is a real map, the intersection of $\varphi(\mathbb{P}^1)$ with each toric divisor consists of some real points and some pairs of complex conjugated points. By definition of a line, the intersection of $\varphi(\mathbb{P}^1)$ with a toric divisor is either empty or consists of a single point. Therefore, each intersection point of $\varphi(\mathbb{P}^1)$ with a toric divisor is necessarily real. \square

Following [34], if the intersection of the image of a line with the toric boundary D consists of two points, we call it a *divalent line*, and if it consists of three points we call it a *trivalent line*. Note that since a line is torically transverse by definition, the associated tropical curve satisfies the balancing condition (4.1). For a line $\varphi: \mathbb{P}^1 \rightarrow X$, let $u_i \in M$ be the primitive generators of the rays corresponding to the divisors of X being intersected, and let w_i be the intersection numbers with φ . Writing $(\mathbf{u}, \mathbf{w}) = ((u_i)_i, (w_i)_i)$, we say that the line φ is of type (\mathbf{u}, \mathbf{w}) .

LEMMA 4.9. — *Let X be a toric variety of dimension n and $a \in \{2, 3\}$. Let*

$$(\mathbf{u}, \mathbf{w}) = ((u_i)_{1 \leq i \leq a}, (w_i)_{1 \leq i \leq a}) \in M^a \times (\mathbb{N} \setminus \{0\})^a$$

with u_i primitive and $\sum_{i=1}^a w_i u_i = 0$. Denote by $\mathbb{L}_{(\mathbf{u}, \mathbf{w})}^{\mathbb{R}}$ the moduli space of real lines whose type is given by (\mathbf{u}, \mathbf{w}) . There is a transitive action of $M \otimes_{\mathbb{Z}} \mathbb{R}^{\times}$ on $\mathbb{L}_{(\mathbf{u}, \mathbf{w})}^{\mathbb{R}}$. Moreover, in the trivalent case this action is simply transitive, while in the divalent case the action factors over a simply transitive action of $(M/\mathbb{Z}u_1) \otimes_{\mathbb{Z}} \mathbb{R}^{\times} = (M/\mathbb{Z}u_2) \otimes_{\mathbb{Z}} \mathbb{R}^{\times}$.

Proof. — Let S be the one- or two-dimensional toric variety defined by the complete fan with rays $\mathbb{Q}u_i$. Then up to a toric birational transformation X is a product $S \times Y$ with Y a complete toric variety, so that the composition of any line $\mathbb{P}^1 \rightarrow S \times Y$ with the projection to the second factor is constant by [34, Lemma 5.2]. Therefore, it suffices to consider the case where $\dim X \leq 2$.

In the divalent case, we can assume $\dim X = 1$, and there is only one isomorphism class of stable real maps $\mathbb{P}^1 \rightarrow X$ that is totally branched over 0 and ∞ .

In the trivalent case, we can assume that $X = S$ is the complete toric surface whose toric fan is given by the rays $\mathbb{Q}u_i$. Let D_1, D_2 , and D_3 be the toric divisors of S respectively dual to the rays $\mathbb{Q}u_1, \mathbb{Q}u_2$ and $\mathbb{Q}u_3$. Let $\varphi: \mathbb{P}^1 \rightarrow S$ be a line in S of type (\mathbf{u}, \mathbf{w}) and let q_1, q_2 , and q_3 be the points of \mathbb{P}^1 respectively mapped by φ on D_1, D_2 , and D_3 . Let y be the unique coordinate on \mathbb{P}^1 such that $y(q_1) = -1, y(q_2) = 0$, and $y(q_3) = 1$. For every $n \in \mathbb{N}$, the monomial z^n is a rational function on S with vanishing order (u_i, m) along D_i , where (\cdot, \cdot) denote the natural duality pairing between

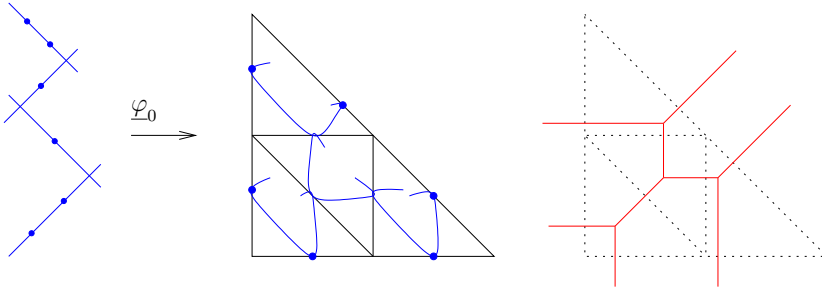

Figure 4.4. A maximally degenerate stable map $\varphi_0 : C_0 \rightarrow X_0 \cong \prod_4 \mathbb{P}^2$, where each \mathbb{P}^2 is identified with its moment map image, and the associated tropical curve.

M and N . It follows that the rational function $\varphi^*(z^n)$ on \mathbb{P}^1 is necessarily of the form

$$\varphi^*(z^n) = \chi_\varphi(n) \prod_{i=1}^3 (y - y(q_i))^{(w_i u_i, n)},$$

for some $\chi_\varphi(n) \in \mathbb{C}^\times$. As $z^{n+n'} = z^n \cdot z^{n'}$ for every $n, n' \in N$, the map $\chi_\varphi : n \mapsto \chi_\varphi(n)$ is a character of N . Therefore, the map $\varphi \mapsto \chi_\varphi$ identifies the set of lines in S of type (\mathbf{u}, \mathbf{w}) with the set $\text{Hom}(N, \mathbb{C}^\times) = M \otimes \mathbb{C}^\times$ of characters of N , which is obviously a torsor under $M \otimes \mathbb{C}^\times$.

A line $\varphi : \mathbb{P}^1 \rightarrow S$ is real if and only if $\chi_\varphi(n) \in \mathbb{R}^\times$ for every $n \in N$. Therefore, the map $\varphi \mapsto \chi_\varphi$ identifies the set of real lines in S of type (\mathbf{u}, \mathbf{w}) with the set $\text{Hom}(N, \mathbb{R}^\times) = M \otimes \mathbb{R}^\times$ of real-valued characters of N , which is obviously a torsor under $M \otimes \mathbb{R}^\times$. \square

Let \mathcal{P} an integral polyhedral decomposition of $M_{\mathbb{Q}}$, and let $\pi : \mathcal{X} \rightarrow \mathbb{A}^1$ be the corresponding toric degeneration, with special fiber X_0 . The irreducible components X_v of X_0 are indexed by the vertices of \mathcal{P} . The notion of maximally degenerate stable map is formulated in [34, Definition 5.6].

DEFINITION 4.10. — Let $\varphi_0 : C_0 \rightarrow X_0$ be a pre-log stable map. If for every $v \in \mathcal{P}^{[0]}$ the projection $C_0 \times_{X_0} X_v \rightarrow X_v$ is a line, or, for $n = 2$, the disjoint union of two divalent lines intersecting disjoint toric divisors, then φ_0 is called maximally degenerate.

We refer to Figure 4.4 for an illustration of a maximally degenerate stable map.

The following Lemma ensures that the two natural ways to define a maximally degenerate real stable map, either as a real stable map which

happens to be maximally degenerate, or as a real stable map obtained from gluing real lines, agree.

LEMMA 4.11. — *Let $\varphi_0 : C_0 \rightarrow X_0$ be a real stable map which is maximally degenerate. Then, for every $v \in \mathcal{P}^{[0]}$, the projection $C_0 \times_{X_0} X_v \rightarrow X_v$ is a real line, or, for $n = 2$, the disjoint union of two divalent real lines intersecting disjoint toric divisors.*

Proof. — Let ι_{C_0} and ι_{X_0} be the real structures on C_0 and X_0 . As X_0 is endowed with the real structure induced by the standard toric real structure on \mathcal{X} , we have $\iota_{X_0}(X_v) = X_v$ for every $v \in \mathcal{P}^{[0]}$. As φ_0 is a real map, it follows that for every $v \in \mathcal{P}^{[0]}$ we have $\iota_{C_0}(C_0 \times_{X_0} X_v) = C_0 \times_{X_0} X_v$. Therefore, when $C_0 \times_{X_0} X_v$ is a line, we deduce that $C_0 \times_{X_0} X_v$ is a real line. When $C_0 \times_{X_0} X_v$ is a disjoint union of two divalent lines intersecting disjoint toric divisors, then each of these two lines is also real because the restriction of ι_{X_0} to X_v preserves the toric divisors of X_v . \square

4.3. Counts of maximally degenerate real stable maps

Let $g \in \mathbb{N}$, $\Delta : M \setminus \{0\} \rightarrow \mathbb{N}$ with finite support, and $\mathbf{A} = (A_1, \dots, A_\ell)$ an affine constraint that is general for (g, Δ) in the sense of Definition 2.11. Recall from Proposition 2.13 that the set $\mathfrak{T}_{g,\ell,\Delta}(\mathbf{A})$ of ℓ -marked genus g tropical curves of degree Δ matching \mathbf{A} is finite. Let \mathcal{P} be a polyhedral decomposition of $M_{\mathbb{Q}}$ which is good for (g, Δ, \mathbf{A}) in the sense of Definition 2.16.

Let $\pi : \mathcal{X} \rightarrow \mathbb{A}^1$ be the toric degeneration defined by \mathcal{P} (see Section 2.2). Let $X_t := \pi^{-1}(t)$ be the fiber of π over $t \in \mathbb{A}^1$. In particular, we denote by X_0 the central fiber of π . We fix $\mathbf{P} = (P_1, \dots, P_\ell)$ a ℓ -tuple of real points in the n -dimensional torus orbit of $X = X_1$. By (2.5)–(2.6), the affine subspaces A_j and the points P_j define incidence conditions

$$\mathcal{Z}_{A_j, P_j} \subset \mathcal{X}$$

and

$$\mathcal{Z}_{A_j, P_j, t} = \mathcal{Z}_{A_j, P_j} \cap X_t \subset X_t.$$

We denote $\mathcal{Z}_{\mathbf{A}, \mathbf{P}} := (\mathcal{Z}_{A_1, P_1}, \dots, \mathcal{Z}_{A_\ell, P_\ell})$ and $\mathbf{Z}_{\mathbf{A}, \mathbf{P}, t} := (Z_{A_1, P_1, t}, \dots, Z_{A_\ell, P_\ell, t})$. In particular, $\mathbf{Z}_{\mathbf{A}, \mathbf{P}, 0}$ is a tuple of incidence conditions in the central fiber X_0 . Because the points P_j are taken to be real, the subvarieties \mathcal{Z}_{A_j, P_j} are real subvarieties of \mathcal{X} , and for $t \in \mathbb{A}^1(\mathbb{R})$, $\mathcal{Z}_{A_j, P_j, t}$ is a real subvariety of X_t .

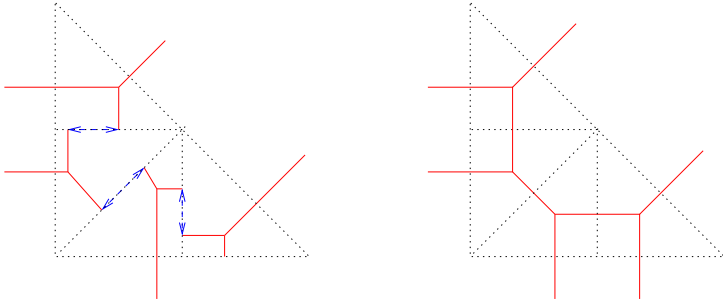

Figure 4.5. The tropical curve in Figure (4.4) obtained by gluing 4 lines.

Let $(\Gamma, \mathbf{E}, h) \in \mathfrak{T}_{g,\ell,\Delta}(\mathbf{A})$. We will study maximally degenerate real stable maps $\varphi_0: C_0 \rightarrow X_0$ matching the incidence conditions $\mathbf{Z}_{\mathbf{A},\mathbf{P},0}$ and with associated tropical curve (Γ, \mathbf{E}, h) (in the sense of Construction 4.3).

It is shown in [34, Proposition 5.7] that the number of maximally degenerate stable maps to X_0 matching the incidence conditions $\mathbf{Z}_{\mathbf{A},\mathbf{P},0}$ and with associated tropical curve (Γ, \mathbf{E}, h) equals the lattice index of the map of lattices

$$\begin{aligned}
 \mathcal{T}_h: \text{Hom}(\Gamma^{[0]}, M) &\longrightarrow \prod_{E \in \Gamma^{[1]} \setminus \Gamma_\infty^{[1]}} M / \mathbb{Z}u_{(\partial^- E, E)} \\
 (4.2) \quad &\times \prod_{j=1}^{\ell} M / ((\mathbb{Q}u_{(\partial^- E_j, E_j)} + L(A_j)) \cap M) \\
 \phi &\longmapsto ((\phi(\partial^+ E) - \phi(\partial^- E))_E, (\phi(\partial^- E_j))_j).
 \end{aligned}$$

In (4.2), the quotient space $M / \mathbb{Z}u_{(\partial^- E, E)}$ can be viewed as a space of directions transverse to the direction $u_{(\partial^- E, E)}$, and the map $\phi \mapsto \phi(\partial^+ E) - \phi(\partial^- E)$ is therefore a measure of how far from $u_{(\partial^- E, E)}$ is the direction of the line segment connecting $\phi(\partial^+ E)$ and $\phi(\partial^- E)$. Similarly, the quotient space $M / ((\mathbb{Q}u_{(\partial^- E_j, E_j)} + L(A_j)) \cap M)$ can be viewed as a space of directions transverse to the subspace spanned by the direction of $u_{(\partial^- E_j, E_j)}$ and the directions parallel to A_j , and so the map $\phi \mapsto \phi(\partial^- E_j)$ is a measure of how far is the direction of $\phi(\partial^- E_j)$ from being contained in this subspace. Recall that the lattice index of a map of lattices is the order of its cokernel, which is also equal to the order of the kernel of the induced map obtained by tensoring both sides with \mathbb{C}^\times . However, this is no longer true once restricting to \mathbb{R}^\times . So, to obtain the analogue of this result for maximally degenerate real stable maps, we first need the following definition.

DEFINITION 4.12. — Let $\Psi : M_1 \rightarrow M_2$ be an inclusion of lattices of finite index. Let

$$(4.3) \quad \text{Coker}(\Psi) = \mathbb{Z}/(p_1)^{e_1}\mathbb{Z} \times \dots \times \mathbb{Z}/(p_n)^{e_n}\mathbb{Z}$$

be the primary decomposition of the free abelian group $\text{Coker}(\Psi)$. We define the real index of Ψ as

$$(4.4) \quad \mathcal{D}_\Psi^{\mathbb{R}} := 2^{\#\{i \mid p_i=2\}}.$$

LEMMA 4.13. — Let $\Psi : M_1 \rightarrow M_2$ be an inclusion of lattices as in Definition 4.12, and let

$$(4.5) \quad \Psi_{\mathbb{R}} : M_1 \otimes_{\mathbb{Z}} \mathbb{R}^\times \longrightarrow M_2 \otimes_{\mathbb{Z}} \mathbb{R}^\times$$

be the map obtained from Ψ by tensoring with \mathbb{R}^\times . Then, $\#\{\text{Ker } \Psi_{\mathbb{R}}\} = \mathcal{D}_\Psi^{\mathbb{R}}$.

Proof. — The proof follows from elementary homological algebra of abelian groups (see for example [48, Chapter 3]). Consider the short exact sequence

$$0 \longrightarrow M_1 \longrightarrow M_2 \longrightarrow \text{Coker}(\Psi) \longrightarrow 0,$$

where $\text{Coker}(\Psi)$ is as in (4.3). Since M_1 and M_2 are free abelian, this is a free resolution of $\text{Coker}(\Psi)$, and tensoring it with \mathbb{R}^\times , we obtain an exact sequence

$$0 \longrightarrow \text{Tor}_1(\mathbb{R}^\times, \text{Coker}(\Psi)) \longrightarrow M_1 \otimes_{\mathbb{Z}} \mathbb{R}^\times \xrightarrow{\Psi_{\mathbb{R}}} M_2 \otimes_{\mathbb{Z}} \mathbb{R}^\times \longrightarrow 0$$

and so

$$\text{Ker}(\Psi_{\mathbb{R}}) = \text{Tor}_1(\mathbb{R}^\times, \text{Coker}(\Psi)).$$

By additivity of the Tor bifunctor, we have

$$\text{Tor}_1(\mathbb{R}^\times, \text{Coker}(\Psi)) = \prod_{j=1}^{\ell} \text{Tor}_1(\mathbb{R}^\times, \mathbb{Z}/(p_j)^{e_j}\mathbb{Z}).$$

For every positive integer m , the free resolution

$$0 \longrightarrow \mathbb{Z} \xrightarrow{\cdot m} \mathbb{Z} \longrightarrow \mathbb{Z}/m\mathbb{Z} \longrightarrow 0$$

induces the short exact sequence

$$0 \longrightarrow \text{Tor}_1(\mathbb{R}^\times, \mathbb{Z}/m\mathbb{Z}) \longrightarrow \mathbb{R}^\times \longrightarrow \mathbb{R}^\times \longrightarrow 0$$

where the right hand side arrow is given by

$$\begin{aligned} \mathbb{R}^\times &\longrightarrow \mathbb{R}^\times \\ r &\longmapsto r^m. \end{aligned}$$

Therefore,

$$\text{Tor}_1(\mathbb{R}^\times, \mathbb{Z}/m\mathbb{Z}) = \begin{cases} 0 & \text{if } m \text{ is odd} \\ \mathbb{Z}/2\mathbb{Z} & \text{if } m \text{ is even.} \end{cases}$$

Hence, the result follows. □

Now we are ready to define the real analogue of the lattice index of [34, Proposition 5.7].

We denote by

$$(4.6) \quad \begin{aligned} M_{2,1}^{\mathcal{T}_h} &:= \prod_{E \in \Gamma^{[1]} \setminus \Gamma_\infty^{[1]}} M/\mathbb{Z}u_{(\partial^- E, E)} \\ M_{2,2}^{\mathcal{T}_h} &:= \prod_{j=1}^\ell M/((\mathbb{Q}u_{(\partial^- E, E)} + L(A_j)) \cap M) \end{aligned}$$

the components of the target of the map \mathcal{T}_h in (4.2). We denote by $Z_{A_j, P_j, 0}(\mathbb{R})$ the real locus of $Z_{A_j, P_j, 0}$. We denote by

$$Z_{j, \mathbb{R}} := Z_{A_j, P_j}^0(\mathbb{R}) \cap (M \otimes_{\mathbb{Z}} \mathbb{R}^\times)$$

the intersection of $Z_{A_j, P_j, 0}(\mathbb{R})$ with the real torus $M \otimes_{\mathbb{Z}} \mathbb{R}^\times$ of the toric component of X_0 containing $Z_{A_j, P_j, 0}$, and

$$\mathbf{Z}_{\mathbb{R}} := (Z_{1, \mathbb{R}}, \dots, Z_{\ell, \mathbb{R}}) \subset \prod_{j=1}^\ell M \otimes_{\mathbb{Z}} \mathbb{R}^\times.$$

We denote by

$$(4.7) \quad [\mathbf{Z}_{\mathbb{R}}]$$

the image in $M_{2,2}^{\mathcal{T}_h} \otimes_{\mathbb{Z}} \mathbb{R}^\times$ of $\mathbf{Z}_{\mathbb{R}}$ by the quotient map

$$\prod_{j=1}^\ell M \otimes_{\mathbb{Z}} \mathbb{R}^\times \longrightarrow M_{2,2}^{\mathcal{T}_h} \otimes_{\mathbb{Z}} \mathbb{R}^\times.$$

In fact, $[\mathbf{Z}_{\mathbb{R}}]$ is a point in $M_{2,2}^{\mathcal{T}_h} \otimes_{\mathbb{Z}} \mathbb{R}^\times$, since the quotient mods out the linear directions of the affine constraints.

DEFINITION 4.14. — We define $\sigma := (0 \otimes 1, [\mathbf{Z}_{\mathbb{R}}]) \in M_{2,1}^{\mathcal{T}_h} \otimes_{\mathbb{Z}} \mathbb{R}^\times \times M_{2,2}^{\mathcal{T}_h} \otimes_{\mathbb{Z}} \mathbb{R}^\times$. We define the real index of \mathcal{T}_h twisted by σ as

$$\mathcal{D}_{\mathcal{T}_h, \sigma}^{\mathbb{R}} := \begin{cases} \mathcal{D}_{\mathcal{T}_h}^{\mathbb{R}}, & \text{if the image of } \sigma \text{ in } \text{Coker}(\mathcal{T}_h) \otimes_{\mathbb{Z}} \mathbb{R}^\times \text{ is } 0 \otimes 1. \\ 0, & \text{otherwise.} \end{cases}$$

where $\mathcal{D}_{\mathcal{T}_h, \sigma}^{\mathbb{R}}$ is the real lattice index of the map \mathcal{T}_h in (4.2).

THEOREM 4.15. — *The number $N_{\mathbf{Z}_{\mathbf{A},\mathbf{P},0},h}^{\mathbb{R}\text{-prelog}}(X_0)$ of isomorphism classes of maximally degenerate real stable maps to X_0 matching the incidence conditions $\mathbf{Z}_{\mathbf{A},\mathbf{P},0}$ and with associated tropical curve $(\Gamma, \mathbf{E}, h) \in \mathfrak{T}_{g,\ell,\Delta}(\mathbf{A})$ is equal to the real lattice index twisted by σ of the map \mathcal{T}_h in (4.2), that is,*

$$N_{\mathbf{Z}_{\mathbf{A},\mathbf{P},0},h}^{\mathbb{R}\text{-prelog}}(X_0) = \mathcal{D}_{\mathcal{T}_h,\sigma}^{\mathbb{R}}.$$

Proof. — After tensoring with \mathbb{Q} , the map of lattices \mathcal{T}_h in (4.2) agrees with the map

$$\begin{aligned} \mathcal{T}_{h,\mathbb{Q}} : \text{Hom}(\Gamma^{[0]}, M_{\mathbb{Q}}) &\longrightarrow \prod_{E \in \Gamma^{[1]} \setminus \Gamma_{\infty}^{[1]}} M_{\mathbb{Q}} / \mathbb{Q}u_{(\partial^- E, E)} \\ &\quad \times \prod_{j=1}^{\ell} M_{\mathbb{Q}} / (\mathbb{Q}u_{(\partial^- E_j, E_j)} + L(A_j)), \\ h &\longmapsto ((h(\partial^+ E) - h(\partial^- E))_E, (h(\partial^- E_j))_j). \end{aligned}$$

Fixing a general constraint \mathbf{A} , we ensure by Corollary [34, Corollary 2.5] that $\mathcal{T}_{h,\mathbb{Q}}$ is an isomorphism, and hence has finite real index. Analogously as in the proof of [34, Proposition 5.7], we will obtain maximally degenerate real curves by gluing real lines. Denote by $\tilde{\Gamma}$ the graph obtained from Γ by inserting vertices at all points $h^{-1}(\mathcal{P}^{[0]}) \setminus \Gamma^{[0]}$ corresponding to the points of intersection of the image of h with the polyhedral decomposition \mathcal{P} , as in [34, Construction 4.4] to ensure the connectivity of the image of φ_0 . It follows from Lemma 4.9 that the moduli space $\prod_{V \in \tilde{\Gamma}^{[0]}} \mathbb{L}_{(\mathbf{u}(V), \mathbf{w}(V))}^{\mathbb{R}}$ of real lines can be identified with the real torus

$$\text{Hom}(\Gamma^{[0]}, M) \otimes_{\mathbb{Z}} \mathbb{R}^{\times} \times \prod_{V \in \tilde{\Gamma}^{[0]} \setminus \Gamma^{[0]}} (M / \mathbb{Z}u_{(V, E^-(V))}) \otimes_{\mathbb{Z}} \mathbb{R}^{\times},$$

where the first factor is given by the real lines corresponding to trivalent vertices and the second one is given by the real lines corresponding to divalent vertices of $\tilde{\Gamma}$.

On the other hand, to glue real lines, which generically lie inside the n -dimensional torus orbits of irreducible components of X_0 pairwise together, we want them to intersect along points at the double locus of X_0 . So, given two the real lines L^- and L^+ , dual to the vertices $\partial^- E$ and $\partial^+ E$ of a bounded edge E , we want them to intersect at a point on the toric variety $X_{h(E)}$ in real points P^- and P^+ . By Lemma 4.8, P^+ and P^- lie in the real $(n - 1)$ -dimensional torus orbit of $X_{h(E)}$. As the real $(n - 1)$ -dimensional torus orbit of $X_{h(E)}$ can be identified with $M / \mathbb{Z}u_{(\partial^- E, E)} \otimes_{\mathbb{Z}} \mathbb{R}^{\times}$, and so the difference between P^+ and P^- can be viewed as an element of

$M/\mathbb{Z}u_{(\partial^-E,E)} \otimes_{\mathbb{Z}} \mathbb{R}^\times$. So, consider the map of real tori

$$(4.8) \quad \text{Hom}(\Gamma^{[0]}, M) \otimes_{\mathbb{Z}} \mathbb{R}^\times \times \prod_{V \in \tilde{\Gamma}^{[0]} \setminus \Gamma^{[0]}} (M/\mathbb{Z}u_{(V,E^-(V))}) \otimes_{\mathbb{Z}} \mathbb{R}^\times \longrightarrow \prod_{E \in \tilde{\Gamma}^{[1]} \setminus \tilde{\Gamma}^{[1]}_\infty} M/\mathbb{Z}u_{(\partial^-E,E)} \otimes_{\mathbb{Z}} \mathbb{R}^\times$$

obtained by tensoring with \mathbb{R}^\times the map of lattices

$$\text{Hom}(\Gamma^{[0]}, M) \times \prod_{V \in \tilde{\Gamma}^{[0]} \setminus \Gamma^{[0]}} M/\mathbb{Z}u_{(V,E^-(V))} \longrightarrow \prod_{E \in \Gamma^{[1]} \setminus \Gamma^{[1]}_\infty} M/\mathbb{Z}u_{(\partial^-E,E)} \\ h \longmapsto ((h(\partial^+E) - h(\partial^-E))_E).$$

The map (4.8) can be thought of assigning to a set of real lines the obstructions to their gluing. Therefore, the set of real maximally degenerate stable maps to X_0 with associated tropical curve $h: \Gamma \rightarrow M_{\mathbb{R}}$ can be identified with the kernel of the map (4.8).

It remains to impose the constraints $\mathbf{Z}_{\mathbf{A},\mathbf{P},0}$. Consider the map of lattices

$$\text{Hom}(\Gamma^{[0]}, M) \times \prod_{V \in \tilde{\Gamma}^{[0]} \setminus \Gamma^{[0]}} (M/\mathbb{Z}u_{(V,E^-(V))}) \longrightarrow \prod_{j=1}^{\ell} M/((\mathbb{Q}u_{(\partial^-E,E)} + L(A_j)) \cap M) \\ h \longmapsto (h(\partial^-E_j)_j)$$

and the induced map of real tori

$$(4.9) \quad \text{Hom}(\Gamma^{[0]}, M) \otimes_{\mathbb{Z}} \mathbb{R}^\times \times \prod_{V \in \tilde{\Gamma}^{[0]} \setminus \Gamma^{[0]}} (M/\mathbb{Z}u_{(V,E^-(V))}) \otimes_{\mathbb{Z}} \mathbb{R}^\times \longrightarrow \prod_{j=1}^{\ell} M/((\mathbb{Q}u_{(\partial^-E,E)} + L(A_j)) \cap M) \otimes_{\mathbb{Z}} \mathbb{R}^\times$$

obtained by tensoring with \mathbb{R}^\times . For every line C_{V_j} attached to a bivalent vertex V_j of $\tilde{\Gamma}$ defined by the intersection of Γ with the constraint A_j , we can consider the real locus $C_{V_j}(\mathbb{R})$ and then the intersection

$$C_{V_j,\mathbb{R}} := C_{V_j}(\mathbb{R}) \cap (M \otimes_{\mathbb{Z}} \mathbb{R}^\times)$$

with the real torus $M \otimes_{\mathbb{Z}} \mathbb{R}^\times$ of the toric component of X_0 containing C_{V_j} . Let $[C_{V_j,\mathbb{R}}]$ be the image of $C_{V_j,\mathbb{R}}$ by the quotient map $M \otimes_{\mathbb{Z}} \mathbb{R}^\times \rightarrow M/((\mathbb{Q}u_{(\partial^-E,E)} + L(A_j)) \cap M) \otimes_{\mathbb{Z}} \mathbb{R}^\times$: it is a point measuring the position of C_{V_j} transversely to the torus $(\mathbb{Q}u_{(\partial^-E,E)} + L(A_j)) \cap M \otimes_{\mathbb{Z}} \mathbb{R}^\times$. The map (4.9) assigns to a tuple $(C_V)_V$ of real lines the tuple $([C_{V_j}]_{j=1,\dots,\ell})$.

On the other hand, the constraints $Z_{A_j, P_j, 0}$ similarly define points $[Z_{j, \mathbb{R}}]$ in $M/((\mathbb{Q}u_{(\partial^- E, E)} + L(A_j)) \cap M) \otimes_{\mathbb{Z}} \mathbb{R}^\times$. A line C_{V_j} matches the constraint $Z_{A_j, P_j, 0}$ if and only if $[C_{V_j, \mathbb{R}}] = [Z_{j, \mathbb{R}}]$. Therefore, the preimage of $[Z_{\mathbb{R}}]$ by the map (4.9) is exactly the set of real lines matching the constraints $\mathbf{Z}_{\mathbf{A}, \mathbf{P}, 0}$.

The map (4.8) restricted to factors associated to the bivalent vertices of $\tilde{\Gamma}$ is an isomorphism onto the factors associated to the bounded edges of $\tilde{\Gamma}$ attached to bivalent vertices, and so removing these factors from the domain and target of (4.8) does not change the kernel of (4.8). We conclude that the set of maximally degenerate real stable maps to X_0 with associated tropical curve $h: \Gamma \rightarrow M_{\mathbb{R}}$ and matching the constraints $\mathbf{Z}_{\mathbf{A}, \mathbf{P}, 0}$ is the preimage of $\sigma := (0 \otimes 1, [Z_{\mathbb{R}}])$ by the map of real tori $\mathcal{T}_{h, \mathbb{R}^\times}$ obtained from the map of lattices \mathcal{T}_h in (4.2) by tensoring with \mathbb{R}^\times . Thus, this set is a torsor under $\text{Ker}(\mathcal{T}_{h, \mathbb{R}^\times})$ if σ is in the image of $\mathcal{T}_{h, \mathbb{R}^\times}$, and empty if σ is not in the image of $\mathcal{T}_{h, \mathbb{R}^\times}$. The result then follows from Lemma 4.13. \square

Let $\varphi_0: C_0 \rightarrow X_0$ be a maximally degenerate real stable map to X_0 matching the incidence conditions $\mathbf{Z}_{\mathbf{A}, \mathbf{P}, 0}$ and with associated tropical curve $(\Gamma, \mathbf{E}, h) \in \mathfrak{T}_{g, \ell, \Delta}(\mathbf{A})$. As explained in [34, Remark 5.8], the proof of [34, Proposition 5.7] in the complex case establishes a bijection between $Z_{A_j, P_j, 0} \cap \varphi_0(C_0)$ and the intersection of the two subtori $(\mathbb{Z}u_{(\partial^- E_j, E_j)}) \otimes_{\mathbb{Z}} \mathbb{C}^\times$ and $(L(A_j) \cap M) \otimes_{\mathbb{Z}} \mathbb{C}^\times$ in $M \otimes_{\mathbb{Z}} \mathbb{C}^\times$. This latter number of intersection points is the covering degree of

$$\begin{aligned} (\mathbb{Z}u_{(\partial^- E_j, E_j)}) \otimes_{\mathbb{Z}} \mathbb{C}^\times \times (L(A_j) \cap M) \otimes_{\mathbb{Z}} \mathbb{C}^\times \\ \longrightarrow ((\mathbb{Q}u_{(\partial^- E_j, E_j)} + L(A_j)) \cap M) \otimes_{\mathbb{Z}} \mathbb{C}^\times, \end{aligned}$$

which equals the index

$$[\mathbb{Z}u_{(\partial^- E_j, E_j)} + L(A_j) \cap M : (\mathbb{Q}u_{(\partial^- E_j, E_j)} + L(A_j)) \cap M].$$

The following proposition is the real analogue of this result.

PROPOSITION 4.16. — *Let $\varphi_0: C_0 \rightarrow X_0$ be a maximally degenerate real stable map to X_0 matching the incidence conditions $\mathbf{Z}_{\mathbf{A}, \mathbf{P}, 0}$ and with associated tropical curve $(\Gamma, \mathbf{E}, h) \in \mathfrak{T}_{g, \ell, \Delta}(\mathbf{A})$. Then, the number of real intersection points of the image of φ_0 with the incidence $Z_{A_j, P_j, 0}$ equals the real lattice index of the inclusion*

$$(4.10) \quad \mathcal{A}_j : \mathbb{Z}u_{(\partial^- E_j, E_j)} + L(A_j) \cap M \longrightarrow (\mathbb{Q}u_{(\partial^- E_j, E_j)} + L(A_j)) \cap M.$$

Proof. — The set of real intersection points between $Z_{A_j, P_j, 0}$ and the image curve $\varphi_0(C_0)$ is in bijection with the intersection of the two subtori $(\mathbb{Z}u_{(\partial^- E_j, E_j)}) \otimes_{\mathbb{Z}} \mathbb{R}^\times$ and $(L(A_j) \cap M) \otimes_{\mathbb{Z}} \mathbb{R}^\times$ in $M \otimes_{\mathbb{Z}} \mathbb{R}^\times$. Therefore, the

number of these real intersection points is the cardinality of the kernel of the map

$$\begin{aligned} (\mathbb{Z}u_{(\partial^- E_j, E_j)}) \otimes_{\mathbb{Z}} \mathbb{R}^\times \times (L(A_j) \cap M) \otimes_{\mathbb{Z}} \mathbb{R}^\times \\ \longrightarrow ((\mathbb{Q}u_{(\partial^- E_j, E_j)} + L(A_j)) \cap M) \otimes_{\mathbb{Z}} \mathbb{R}^\times \\ (z_1, z_2) \longmapsto z_1 z_2^{-1}. \end{aligned}$$

The result then follows from Lemma 4.13. □

5. From real maximally degenerate curves to real log curves

In this section, we stay in the setup of Section 4.3. We compute the numbers of ways to lift a maximally degenerate real stable map $\varphi_0 : \underline{C}_0 \rightarrow X_0$ to a real stable log map $\varphi_0 : C_0 \rightarrow X_0$ in the sense of Definition 3.22. Recall from Section 3.1 that we view X_0 as a log scheme log smooth over the standard log point O_0 . We denote by $\pi_0 : X_0 \rightarrow O_0$ the corresponding log morphism.

A ℓ -marked maximally degenerate real stable map $(\varphi_0 : \underline{C}_0 \rightarrow X_0, \mathbf{x}_0)$ is a maximal degenerate real stable map $\varphi_0 : \underline{C}_0 \rightarrow X_0$ with a ℓ -tuple $\mathbf{x}_0 = (x_{0,1}, \dots, x_{0,\ell})$ of real marked points. We say that $(\varphi_0 : \underline{C}_0 \rightarrow X_0, \mathbf{x}_0)$ matches incidence conditions $\mathbf{Z}_{\mathbf{A}, \mathbf{P}, 0}$ if $\varphi_0(x_{0,j}) \in Z_{A_j, P_j, 0}$ for every $j = 1, \dots, \ell$.

THEOREM 5.1. — *Let $(\varphi_0 : \underline{C}_0 \rightarrow X_0, \mathbf{x}_0)$ be a marked maximally degenerate real stable map matching incidence conditions $\mathbf{Z}_{\mathbf{A}, \mathbf{P}, 0}$. Let (Γ, \mathbf{E}, h) be the associated tropical curve, where $\mathbf{E} = (E_1, \dots, E_\ell)$. For any $E \in \Gamma^{[1]}$ set $w^{\mathbb{R}}(E) = 2$ if $w(E)$ is even, and $w^{\mathbb{R}}(E) = 1$ if $w(E)$ is odd. Let $w^{\mathbb{R}}(\Gamma, \mathbf{E})$ be the total real weight of (Γ, \mathbf{E}) defined by*

$$(5.1) \quad w^{\mathbb{R}}(\Gamma, \mathbf{E}) := \prod_{E \in \Gamma^{[1]} \setminus \Gamma_\infty^{[1]}} w^{\mathbb{R}}(E) \cdot \prod_{j=1}^{\ell} w(E_j).$$

Then there are exactly $w^{\mathbb{R}}(\Gamma, \mathbf{E})$ pairwise non-isomorphic pairs $(\varphi_0 : C_0/O_0 \rightarrow X_0, \mathbf{x}_0)$ of real stable maps over the standard log point O_0 with underlying marked stable map isomorphic to φ_0 , and such that φ_0 is strict at $p \in \underline{C}_0$ as in Definition 3.13 if $p \notin \mathbf{x}$ and $\pi_0 : X_0 \rightarrow O_0$ is strict at $\varphi_0(p)$.

Before proving Theorem 5.1, we will analyse the action of the real involution on nodal points of log curves.

LEMMA 5.2. — *Let q be a nodal point on a log smooth curve (C, \mathcal{M}_C) over the standard log point. Let $\beta_\zeta : S_e \rightarrow \mathcal{O}_{C,q}$, be a chart defined as in Remark 3.17 for a root of unity $\zeta \in \mathbb{C}^\times$. Let (ι, ι^b) on (C, \mathcal{M}_C) be a real structure on (C, \mathcal{M}_C) lifting the standard real involution ι on \underline{C} . Then, étale locally, on a neighbourhood of q , the involution ι^b is defined as*

$$\begin{aligned} \phi : S_e \oplus_{\beta_\zeta^{-1}(\mathcal{O}_C^\times)} \mathcal{O}_C^\times &\longmapsto S_e \oplus_{\beta_\zeta^{-1}(\mathcal{O}_C^\times)} \mathcal{O}_C^\times \\ (p, h) &\longmapsto (\phi_1(p), \phi_2(p) \cdot \iota(h)) \end{aligned}$$

where $\phi_1 : S_e \rightarrow S_e$ is the identity, and $\phi_2 : S_e \rightarrow \mathcal{O}_C^\times$ is given by

$$s_{((1,0),0)} \mapsto \zeta^2, \quad s_{((0,1),0)} \mapsto 1, \quad s_{((0,0),1)} \mapsto 1.$$

Proof. — In order to use uniformly multiplicative notation for monoids, we denote $t^p h$ for (p, h) where $p \in S_e$ and $h \in \mathcal{O}_C^\times$. Here t^p is simply a formal multiplicative notation for $p \in S_e$. We have $t^p \cdot t^{p'} = t^{p+p'}$ for every $p, p' \in S_e$.

The real log structure being a lift of the real structure ι on \underline{C} , we necessarily have $\phi(h) = \iota(h)$ for every $h \in \mathcal{O}_C^\times$.

We can write $\phi(t^p) = t^{\phi_1(p)} \phi_2(p)$, where $\phi_1 : S_e \rightarrow S_e$ and $\phi_2 : S_e \rightarrow \mathcal{O}_C^\times$ are morphisms of monoids. Writing that ϕ is an involution, we obtain

$$t^p = \phi^2(t^p) = \phi(t^{\phi_1(p)} \phi_2(p)) = \phi(t^{\phi_1(p)}) \phi(\phi_2(p)).$$

Since $\phi_2(p) \in \mathcal{O}_C^\times$, we have $\phi(\phi_2(p)) = \iota(\phi_2(p))$. On the other hand, we have

$$\phi(t^{\phi_1(p)}) = t^{\phi_1^2(p)} \phi_2(p)$$

by the definition of ϕ . Therefore, we have

$$p = t^{\phi_1^2(p)} \phi_2(p) \iota(\phi_2(p)),$$

where $\phi_1^2(p) \in S_e$ and $\phi_2(p) \iota(\phi_2(p)) \in \mathcal{O}_C^\times$. Since each component of C remains invariant under the standard involution ι on C , we get $\phi_1 = \text{Id}$. Hence, we obtain $\phi(t^p) = \phi_2(p) \cdot t^p$. Therefore, we have

$$\phi(s_{((1,0),0)}) = \phi_2(s_{((1,0),0)}) s_{((1,0),0)}.$$

Thus,

$$(5.2) \quad \beta_\zeta(\phi(s_{((1,0),0)})) = \phi_2(s_{((1,0),0)}) \zeta^{-1} z$$

where β_ζ is the chart defined as in Remark 3.17. Moreover, since ϕ is compatible with ι , we have $\beta_\zeta \phi = \iota \beta_\zeta$. Hence,

$$(5.3) \quad \beta_\zeta(\phi(s_{((1,0),0)})) = \iota(\zeta^{-1} z) = \overline{\zeta^{-1} z} = \zeta.$$

From equations (5.2) and (5.3), it follows that $\phi_2(s_{((1,0),0)})\zeta^{-1} = \zeta$, hence

$$\phi_2(s_{((1,0),0)}) = \zeta^2.$$

By an analogous computation, we obtain

$$\phi_2(s_{((0,1),0)}) = \phi_2(s_{((0,0),1)}) = 1. \quad \square$$

Now we are ready to prove the main result of this section.

Proof of Theorem 5.1. — The locus of strictness of π_0 is the union of the n -dimensional torus orbits of the toric irreducible components of X_0 ,

$$\mathring{X}_0 := X_0 \setminus (\text{Sing}(X_0) \amalg \partial X_0),$$

where by ∂X_0 we denote the degeneration of the toric boundary of the general fibers.

By the strictness condition in the statement of Theorem 5.1, a log lift φ_0 of φ_0 is completely determined away from the union of the nodes of \underline{C}_0 , of the marked points $x_{0,i}$, and of the preimages of ∂X_0 .

At the preimages of ∂X_0 , toric transversality guarantees the uniqueness of the log extension, as in the proof of Proposition 7.1 in [34]. Similarly, the marked points $x_{0,i}$ map to \mathring{X}_0 and so there is a unique log extension at these points.

It thus remains to investigate the nodal points. We will show that at a node $q \in C_0$, corresponding to a bounded edge $E \in \tilde{\Gamma}^{[1]}$, if we fix local coordinates on the two components of C_0 meeting at q , there are precisely

$$\mu^{\mathbb{R}} := w^{\mathbb{R}}(E)$$

pairwise non-isomorphic extensions of $\varphi_0^* \mathcal{M}_{X_0}$ to a real log structure \mathcal{M}_{C_0} , log smooth over O_0 . We denote by e the integral length of $h(E)$. Recall that by definition of a good polyhedral decomposition, the weight $w(E)$ divides e .

By toric transversality, the node q maps to the $(n - 1)$ -dimensional torus orbit of the $n - 1$ -dimensional toric variety $X_{h(E)} \subset (X_0)_{\text{sing}}$, and the intersection numbers of the branches of C meeting at q with $X_{h(E)}$ equal $\mu := w(E)$. It is shown in [34, Proposition 7.1] that there exist precisely μ non-isomorphic extensions of $\varphi_0^* \mathcal{M}_{X_0}$ to a log smooth structure in a neighbourhood of q , and each of these extensions differ by a well-defined μ^{th} root of unity $\zeta \in \mathbb{C}^\times$, giving rise to μ non-isomorphic log maps $\varphi_1, \dots, \varphi_\mu$, where for each such map a chart for the domain curve around the node q

is given by chart

$$(5.4) \quad \begin{aligned} \beta_\zeta: S_{e/\mu} &\longrightarrow \mathcal{O}_{C,q} \\ ((a, b), c) &\longmapsto \begin{cases} (\zeta^{-1}z^a)w^b & \text{if } c = 0 \\ 0 & \text{if } c \neq 0 \end{cases} \end{aligned}$$

and the following relation holds

$$(5.5) \quad s_{((1,0),0)} \cdot s_{((0,1),0)} = s_{((0,0),e/\mu)}.$$

We show that there is a real log structure (ι, ι^\flat) on (C_0, M_{C_0}) lifting the standard real structure on C_0 if and only if ζ is real, and that in such case this real log structure is unique. By Lemma 5.2, such real log structure (ι, ι^\flat) is of the form

$$\iota^\flat(s_{((1,0),0)}) = \zeta^2, \quad \iota^\flat(s_{((0,1),0)}) = 1, \quad \iota^\flat(s_{((0,0),1)}) = 1.$$

Applying ι^\flat to both sides of the Equation (5.5), we obtain $\zeta^2 = 1$, hence $\zeta \in \mathbb{R}$. Therefore, fixing local coordinates on branches of nodes, we obtain

$$\prod_{E \in \tilde{\Gamma}^{[1]} \setminus \tilde{\Gamma}^{[1]}_\infty} w^{\mathbb{R}}(E)$$

many real log lifts $\varphi_0: C_0 \rightarrow X_0$ of the real stable map $\underline{\varphi}_0: \underline{C}_0 \rightarrow X_0$. It remains to show that, allowing action of reparametrizations of local coordinates, these real log lifts define

$$\prod_{E \in \Gamma^{[1]} \setminus \Gamma^{[1]}_\infty} w^{\mathbb{R}}(E) \prod_{j=1}^{\ell} w(E_j)$$

isomorphism classes. As in the proof of [34, Proposition 7.1], it is enough to consider the action of the group $\text{Aut}^{\mathbb{R}, \varphi_0}(\underline{C}_0, \mathbf{x}_0)$ of real automorphisms of \underline{C}_0 fixing the marked points and commuting with the map $\underline{\varphi}_0$. As $\underline{\varphi}_0$ is an immersion, such automorphism preserves the components and fixes the nodes of \underline{C}_0 . As the components of \underline{C}_0 are projective lines, the action of $\text{Aut}^{\mathbb{R}, \varphi_0}(\underline{C}_0, \mathbf{x}_0)$ is non-trivial only on the components of \underline{C}_0 containing at most two special points, that is corresponding to unmarked divalent vertices of $\tilde{\Gamma}$. Let V be an unmarked divalent vertex of $\tilde{\Gamma}$ and let w_V be the common weight of the two edges attached to V . In restriction to the component of \underline{C}_0 corresponding to V , $\underline{\varphi}_0$ is a cover of \mathbb{P}^1 by \mathbb{P}^1 of degree w_V and fully ramified at two points. Thus, denoting $w_V^{\mathbb{R}}$ the common real weight of the two edges attached to V , the unmarked bivalent vertex V contributes a factor $\mathbb{Z}/w_V^{\mathbb{R}}\mathbb{Z}$ to $\text{Aut}^{\mathbb{R}, \varphi_0}(\underline{C}_0, \mathbf{x}_0)$.

Let us study the action of $\text{Aut}^{\mathbb{R}, \varphi_0}(\underline{C}_0, \mathbf{x}_0)$ on the $\prod_{E \in \tilde{\Gamma}^{[1]} \setminus \tilde{\Gamma}^{[1]_\infty}} w^{\mathbb{R}}(E)$ real log structures constructed above. Let V_1, \dots, V_n be a maximal chain of unmarked bivalent vertices of $\tilde{\Gamma}$ and let e_1, \dots, e_{n-1} be the bounded edges of $\tilde{\Gamma}$ between V_1 and V_2, \dots, V_{n-1} and V_n respectively. Let V_0 be a vertex of $\tilde{\Gamma}$ which is not unmarked bivalent and which is attached to the chain. Necessarily, V_0 is either connected to V_1 or V_n , and up to relabelling, we assume that V_0 is connected to V_1 by an edge e_0 . For every $j = 1, \dots, n$, the $w^{\mathbb{R}}(e_{j-1}) = w^{\mathbb{R}}_{V_j}$ log structures attached to the edge E_{j-1} form a torsor under the factor $\mathbb{Z}/w^{\mathbb{R}}_{V_j}\mathbb{Z}$ of $\text{Aut}^{\mathbb{R}, \varphi_0}(\underline{C}_0, \mathbf{x}_0)$ attached to the vertex V_j . In particular, the $\prod_{j=0}^{n-1} w(e_j)$ log structures attached to the edges e_0, \dots, e_{n-1} all become isomorphic under the action of $\text{Aut}^{\mathbb{R}, \varphi_0}(\underline{C}_0, \mathbf{x}_0)$.

Therefore, the number of isomorphism classes of real log structures after action of $\text{Aut}^{\mathbb{R}, \varphi_0}(\underline{C}_0, \mathbf{x}_0)$ on the

$$\prod_{E \in \tilde{\Gamma}^{[1]} \setminus \tilde{\Gamma}^{[1]_\infty}} w^{\mathbb{R}}(E)$$

real log structures previously constructed is obtained by replacing all the factors $\prod_{j=0}^{n-1} w(e_j)$ by 1. As going from $\tilde{\Gamma}$ to Γ subdivided by the marked points consists precisely in erasing all the chains V_1, \dots, V_n of unmarked bivalent vertices and so all the corresponding edges e_0, \dots, e_{n-1} . Hence, it follows that the number of real log maps with underlying map given by φ_0 is indeed

$$\prod_{E \in \Gamma^{[1]} \setminus \Gamma^{[1]_\infty}} w^{\mathbb{R}}(E) \prod_{j=1}^{\ell} w(E_j). \quad \square$$

6. Deformation theory for real log curves

In this section we show that given a maximally degenerate real log map in the central fiber of a toric degeneration there exists a unique real stable log map obtained by a deformation of it. Throughout this section, for every log morphism $Y \rightarrow Z$, between two log schemes Y and Z we denote by $\Theta_{Y/Z}$ the associated relative log tangent sheaf. Also, for every real scheme Y , we denote by $Y^{\mathbb{R}}$ the corresponding scheme over $\text{Spec } \mathbb{R}$, so that $Y = Y^{\mathbb{R}} \times_{\text{Spec } \mathbb{R}} \text{Spec } \mathbb{C}$. Similarly, for every real sheaf E on a real scheme Y , we denote by $E^{\mathbb{R}}$ the corresponding sheaf on $Y^{\mathbb{R}}$, so that $E = E^{\mathbb{R}} \times_{\text{Spec } \mathbb{R}} \text{Spec } \mathbb{C}$. Note that $H^0(Y^{\mathbb{R}}, E^{\mathbb{R}}) = H^0(Y, E)^{\mathbb{R}}$, but $H^i(Y^{\mathbb{R}}, E^{\mathbb{R}}) \neq H^i(Y, E)^{\mathbb{R}}$ in general for $i > 0$.

Let $g \in \mathbb{N}$, $\Delta: M \setminus \{0\} \rightarrow \mathbb{N}$ with finite support, and $\mathbf{A} = (A_1, \dots, A_\ell)$ an affine constraint that is general for (g, Δ) in the sense of Definition 2.11. Let \mathcal{P} be a polyhedral decomposition of $M_{\mathbb{Q}}$ which is good for (g, Δ, \mathbf{A}) in the sense of Definition 2.16. Let $\pi: \mathcal{X} \rightarrow \mathbb{A}^1$ be the toric degeneration defined by \mathcal{P} (see Section 2.2). Let $X_t := \pi^{-1}(t)$ be the fiber of π over $t \in \mathbb{A}^1$. In particular, we denote by X_0 the central fiber of π . We fix $\mathbf{P} = (P_1, \dots, P_\ell)$ a ℓ -tuple of real points in the n -dimensional torus orbit of $X = X_1$. By (2.5)–(2.6), the affine subspaces A_j and the points P_j define incidence conditions $\mathcal{Z}_{A_j, P_j} \subset \mathcal{X}$ and $Z_{A_j, P_j, t} = \mathcal{Z}_{A_j, P_j} \cap X_t \subset X_t$. We denote $\tilde{\mathcal{Z}}_{\mathbf{A}, \mathbf{P}} := (\mathcal{Z}_{A_1, P_1}, \dots, \mathcal{Z}_{A_\ell, P_\ell})$ and $\mathbf{Z}_{\mathbf{A}, \mathbf{P}, t} := (Z_{A_1, P_1, t}, \dots, Z_{A_\ell, P_\ell, t})$. In particular, $\mathbf{Z}_{\mathbf{A}, \mathbf{P}, 0}$ is a tuple of incidence conditions in the central fiber X_0 .

Let $(\varphi_0: C_0/O_0 \rightarrow X_0, \mathbf{x}_0)$ be a maximally degenerate ℓ -marked real stable log map over the standard log point O_0 as in Theorem 5.1 and matching incidence conditions $\mathbf{Z}_{\mathbf{A}, \mathbf{P}, 0}$, with associated tropical curve $(\Gamma, \mathbf{E}, h) \in \mathfrak{T}_{g, \ell, \Delta}(\mathbf{A})$. Recall that $\varphi_0: C_0 \rightarrow X_0$ is strict wherever $X_0 \rightarrow O_0$ is strict and that we are not at a marked point. For every nonnegative integer k , we consider the thickening

$$O_k := \text{Spec } \mathbb{C}[t]/(t^{k+1}),$$

endowed with the real log structure obtained by asking that the inclusion $O_k \hookrightarrow \mathbb{A}^1$ is strict, that is, the log structure on O_k is defined by the chart $\mathbb{N} \rightarrow \mathcal{O}_{O_k}$, $1 \mapsto t$. We will study the lifts order by order in k of $(\varphi_0: C_0/O_0 \rightarrow X_0, \mathbf{x})$ into a ℓ -marked real stable map $(\varphi_k: C_k/O_k \rightarrow \mathcal{X})$ over O_k matching the constraints $\tilde{\mathbf{Z}}_{\mathbf{A}, \mathbf{P}}$. Over \mathbb{C} without taking into account real structures, an analogous study has been done in [11, 33, 34] using log smooth deformation theory [28, 29, 30]. We explain below how to incorporate the real structures in this deformation argument.

The deformation theory of $(\varphi_0: C_0/O_0 \rightarrow X_0)$ is controlled by the logarithmic normal sheaf $\mathcal{N}_{\varphi_0} := \varphi_0^* \Theta_{X_0/O_0} / \Theta_{C_0/O_0}$. Real log structures on X_0/O_0 and C_0/O_0 induce real structures on the logarithmic tangent sheaves Θ_{X_0/O_0} and Θ_{C_0/O_0} respectively. As φ_0 is a real log map, the real structure on Θ_{C_0/O_0} is induced by the real structure on $\varphi_0^* \Theta_{X_0/O_0}$, and so the quotient $\mathcal{N}_{\varphi_0} = \varphi_0^* \Theta_{X_0/O_0} / \Theta_{C_0/O_0}$ admits a natural real structure.

LEMMA 6.1. — *Let $(\varphi_{k-1}: C_{k-1}/O_{k-1} \rightarrow \mathcal{X})$ be a real stable log map over O_{k-1} lifting $(\varphi_0: C_0/O_0 \rightarrow X_0)$. Then the set of isomorphism classes of real stable log maps $(\varphi_k: C_k/O_k \rightarrow \mathcal{X})$ over O_k lifting φ_{k-1} is a torsor under $H^0(C_0^{\mathbb{R}}, \mathcal{N}_{\varphi_0}^{\mathbb{R}}) = H^0(C_0, \mathcal{N}_{\varphi_0})^{\mathbb{R}}$.*

Proof. — Since the log smooth deformation theory of [28, 29, 30] is valid over any base field, it suffices to essentially follow the arguments of [11,

33, 34]. We first prove that the set of real lifts $(\varphi_k: C_k/O_k \rightarrow \mathcal{X})$ of φ_{k-1} is not empty. As $C_0^{\mathbb{R}}$ is of dimension one, we have $H^2(C_0^{\mathbb{R}}, \Theta_{C_0/O_0}^{\mathbb{R}}) = 0$, so deformations of a real log smooth curve are unobstructed and so there exists a real log smooth lift C_k/O_k of C_{k-1}/O_{k-1} .

By [11, Proposition 3.3], whose proof uses general log smooth deformation theory and so is valid over any base field, to show the existence of a real lift $(\varphi_k: C_k/O_k \rightarrow \mathcal{X})$ of φ_{k-1} , it is enough to show that the natural map

$$(6.1) \quad H^1(C_0^{\mathbb{R}}, \Theta_{C_0/O_0}^{\mathbb{R}}) \rightarrow H^1(C_0^{\mathbb{R}}, \varphi_0^* \Theta_{X_0/O_0}^{\mathbb{R}})$$

is surjective. As Γ is trivalent, the map (6.1) can be identified by the proof of [11, Proposition 4.2] with the abundancy map

$$(6.2) \quad \begin{aligned} \mathbb{R}^{\sharp E(\Gamma)} &\longrightarrow \text{Hom}(H_1(\Gamma), M_{\mathbb{R}}) \\ (l_E) &\longmapsto \left(\sum_E a_E [E] \mapsto \sum_E a_E l_E (h(\partial^+ E) - h(\partial^- E)) \right) \end{aligned}$$

which is surjective as (Γ, h) is non-superabundant. This concludes the proof of existence of a lift φ_k of φ_{k-1} .

The fact that the set of real lifts of φ_{k-1} is a pseudo torsor under $H^0(C_0, \mathcal{N}_{\varphi_0})^{\mathbb{R}}$ follows from general deformation theory arguments which are valid over any base field, see the last part of the proof of [34, Lemma 7.2]. □

LEMMA 6.2. — *Let $(\varphi_{k-1}: C_{k-1}/O_{k-1} \rightarrow \mathcal{X}, \mathbf{x}_{k-1})$ be a real stable log map over O_{k-1} lifting $(\varphi_0: C_0/O_0 \rightarrow \mathcal{X}, \mathbf{x}_0)$ and matching the constraints $\mathcal{Z}_{\mathbf{A}, \mathbf{P}}$. Then up to isomorphism there exists a unique real stable log map*

$$(\varphi_k: C_k/O_k \rightarrow X, \mathbf{x}_k)$$

over O_k matching the constraints $\mathcal{Z}_{\mathbf{A}, \mathbf{P}}$ and lifting φ_{k-1} .

Proof. — As in the proof of [34, Proposition 7.3], we denote by T_y the fiber at a closed point y of a log tangent sheaf Θ . As the real log map φ_0 is real and the constraints \mathcal{Z}_{A_i, P_i} are real, the transversality map

$$H^0(C_0, \mathcal{N}_{\varphi_0}) \longrightarrow \prod_i T_{\mathcal{X}/\mathbb{A}^1, \varphi_0(x_i)} / (T_{\mathcal{Z}_{A_i, P_i}/\mathbb{A}^1, \varphi_0(x_i)} + D\varphi_0(T_{C_0/O_0, x_i}))$$

is real.

According to [34, Proposition 7.3], the transversality map is an isomorphism. Therefore, as the transversality map is real, it induces an isomorphism at the level of real subspaces:

$$H^0(C_0, \mathcal{N}_{\varphi_0})^{\mathbb{R}} \simeq \prod_i T_{\mathcal{X}/\mathbb{A}^1, \varphi_0(x_i)}^{\mathbb{R}} / (T_{\mathcal{Z}_{A_i, P_i}/\mathbb{A}^1, \varphi_0(x_i)}^{\mathbb{R}} + D\varphi_0(T_{C_0/O_0, x_i}^{\mathbb{R}})).$$

As by Lemma 6.1 the set of real lifts $(\varphi_k: C_k/O_k \rightarrow \mathcal{X})$ of φ_{k-1} is a torsor under $H^0(C_0, \mathcal{N}_{\varphi_0})^{\mathbb{R}}$, this isomorphism implies Lemma 6.2 \square

THEOREM 6.3. — *There exists a unique real stable log map*

$$(\varphi_{\infty}: C_{\infty}/O_{\infty} \rightarrow \mathcal{X})$$

over $O_{\infty} := \text{Spec } \mathbb{C}[[t]]$, matching the constraints $\mathcal{Z}_{\mathbf{A}, \mathbf{P}}$ and lifting

$$(\varphi_0: C_0/O_0 \rightarrow X_0, \mathbf{x}_0).$$

Proof. — We take the limit $k \rightarrow +\infty$ of Lemma 6.2 and use the existence of the moduli space of stable maps, as in the proof of [34, Corollary 7.4]. \square

7. The tropical correspondence theorem for real log curves

Let X be a n -dimensional proper toric variety, defined by a complete fan Σ in $M_{\mathbb{R}}$. Fix a tuple $(g, \Delta, \mathbf{A}, \mathbf{P})$, where:

- g is a nonnegative integer.
- Δ is a map $\Delta: M \setminus \{0\} \rightarrow \mathbb{N}$ with support contained in the union of rays of Σ . The choice of Δ specifies a degree and tangency conditions along the toric divisors for a curve in X , and a tropical degree for a tropical curve in $M_{\mathbb{R}}$. We denote by $|\Delta|$ the number of $v \in M \setminus \{0\}$ with $\Delta(v) \neq 0$.
- $\mathbf{A} = (A_1, \dots, A_{\ell})$ is an affine constraint that is general for (g, Δ) in the sense of Definition 2.11.
- $\mathbf{P} = (P_1, \dots, P_{\ell})$ is a tuple of real points in the n -dimensional torus orbit of X .

Let \mathcal{P} be a polyhedral decomposition of $M_{\mathbb{Q}}$ which is good for (g, Δ, \mathbf{A}) in the sense of Definition 2.16. Let $\pi: \mathcal{X} \rightarrow \mathbb{A}^1$ be the toric degeneration defined by \mathcal{P} (see Section 2.2). Let $X_t := \pi^{-1}(t)$ be the fiber of π over $t \in \mathbb{A}^1$. In particular, we denote by X_0 the central fiber of π . We fix $\mathbf{P} = (P_1, \dots, P_{\ell})$ a ℓ -tuple of real points in the n -dimensional torus orbit of $X = X_1$. By (2.5)–(2.6), the affine subspaces A_j and the points P_j define incidence conditions $\mathcal{Z}_{A_j, P_j} \subset \mathcal{X}$ and $Z_{A_j, P_j, t} = \mathcal{Z}_{A_j, P_j} \cap X_t \subset X_t$. We denote $\mathcal{Z}_{\mathbf{A}, \mathbf{P}} := (\mathcal{Z}_{A_1, P_1}, \dots, \mathcal{Z}_{A_{\ell}, P_{\ell}})$ and $\mathbf{Z}_{\mathbf{A}, \mathbf{P}, t} := (Z_{A_1, P_1, t}, \dots, Z_{A_{\ell}, P_{\ell}, t})$. Because the points P_j are taken to be real, the subvarieties \mathcal{Z}_{A_j, P_j} are real subvarieties of \mathcal{X} , and for $t \in \mathbb{A}^1(\mathbb{R})$, $Z_{A_j, P_j, t}$ is a real subvariety of X_t .

For every $t \in \mathbb{A}^1(\mathbb{R}) \setminus \{0\} \simeq \mathbb{R}^{\times}$, the number of real curves in X_t of degree Δ and constrained by $\mathbf{Z}_{\mathbf{A}, \mathbf{P}, t}$, which we denote by $N_{(g, \Delta, \mathbf{A}, \mathbf{P}), t}^{\mathbb{R}-\log}$, is defined as follows. Recall that the toric prime divisors on X are in correspondence with

primitive generators of the rays of the toric fan Σ for X . Denote by D_v the toric divisor corresponding to $v \in M$. For a torically transverse real stable map $\varphi : C \rightarrow X$ (Definition 4.1), and for $\lambda \in \mathbb{N}$, define P_λ as the number of points of multiplicity λ in φ^*D_v , and define a map $\Delta(\varphi) : M \setminus \{0\} \rightarrow \mathbb{N}$ by setting

$$(7.1) \quad \Delta(\varphi)(\lambda \cdot v) = \begin{cases} 0 & \text{if } \mathbb{Q}_{\geq 0}v \notin \Sigma^{[1]} \\ P_\lambda & \text{otherwise.} \end{cases}$$

So, $\Delta(\varphi)$ records the data of the number of intersection points with the toric prime divisors of any given multiplicity, and clearly has finite support. Let $M_{(g,\Delta,\mathbf{A},\mathbf{P}),t}^{\mathbb{R}\text{-log}}$ be the set of isomorphism classes of real torically transverse ℓ -marked stable maps $(\varphi : C \rightarrow X_t, \mathbf{x})$ of genus g and matching the constraints $\mathbf{Z}_{\mathbf{A},\mathbf{P},t}$. Define

$$(7.2) \quad N_{(g,\Delta,\mathbf{A},\mathbf{P}),t}^{\mathbb{R}\text{-log}} := \# M_{(g,\Delta,\mathbf{A},\mathbf{P}),t}^{\mathbb{R}\text{-log}}.$$

The count of real curves $N_{(g,\Delta,\mathbf{A},\mathbf{P}),t}^{\mathbb{R}\text{-log}}$ is a piecewise constant function of $t \in \mathbb{A}^1(\mathbb{R}) \setminus \{0\} \simeq \mathbb{R}^\times$, possibly jumping at the finitely many values of t for which the constraints $\mathbf{Z}_{\mathbf{A},\mathbf{P},t}$ become non-generic. We denote by t_+ (resp. t_-) the smallest positive (resp. biggest negative) value of t at which $N_{(g,\Delta,\mathbf{A},\mathbf{P}),t}^{\mathbb{R}\text{-log}}$ jumps. In particular, $N_{(g,\Delta,\mathbf{A},\mathbf{P}),t}^{\mathbb{R}\text{-log}}$ is a locally constant function of t for $t \in (t_-, t_+) \setminus \{0\}$.

We now define a tropical count. Let $\mathfrak{T}_{g,\ell,\Delta}(\mathbf{A})$ be the set of genus g ℓ -marked tropical curves of degree Δ and matching \mathbf{A} . This set is finite by Proposition 2.13. Define

$$(7.3) \quad N_{(g,\Delta,\mathbf{A},\mathbf{P})}^{\mathbb{R}\text{-trop}} := \sum_{(\Gamma, \mathbf{E}, h) \in \mathfrak{T}_{g,\ell,\Delta}(\mathbf{A})} w^{\mathbb{R}}(\Gamma, \mathbf{E}) \cdot \mathcal{D}_{\mathcal{T}_h, \sigma}^{\mathbb{R}} \cdot \prod_{i=1}^{\ell} \mathcal{D}_{\mathcal{A}_i}^{\mathbb{R}},$$

where $w^{\mathbb{R}}(\Gamma, \mathbf{E})$ is the total real weight defined as in (5.1), $\mathcal{D}_{\mathcal{T}, \sigma}^{\mathbb{R}}$ is the twisted real lattice index of the map \mathcal{T}_h (see (4.2)), and $\mathcal{D}_{\mathcal{A}_i}^{\mathbb{R}}$ is the real lattice index of the inclusion of lattices \mathcal{A}_i defined in (4.10) (recall that the real lattice index is defined in Definition 4.12 and the twisted real lattice index is defined in Definition 4.14). Remark that, unlike its complex analogue, the count of tropical curves $N_{(g,\Delta,\mathbf{A},\mathbf{P})}^{\mathbb{R}\text{-trop}}$ depends on \mathbf{P} through the twist by σ in the definition of $\mathcal{D}_{\mathcal{T}_h, \sigma}^{\mathbb{R}}$.

THEOREM 7.1. — *For every tuple $(g, \Delta, \mathbf{A}, \mathbf{P})$ as above, we have*

$$(7.4) \quad N_{(g,\Delta,\mathbf{A},\mathbf{P}),t}^{\mathbb{R}\text{-log}} = N_{(g,\Delta,\mathbf{A},\mathbf{P})}^{\mathbb{R}\text{-trop}}$$

for every $t \in (t_-, t_+) \setminus \{0\}$.

Proof. — By Theorem 4.15, $\mathcal{D}_{\mathcal{T}_h, \sigma}^{\mathbb{R}}$ is the number of real maximally degenerate curves in X_0 intersecting $\mathbf{Z}_{\mathbf{A}, \mathbf{P}, 0}$ and with associated tropical curve $h: \Gamma \rightarrow M_{\mathbb{R}}$. For every $1 \leq j \leq \ell$, the image of such real maximally degenerate curve $\varphi_0: \underline{C}_0 \rightarrow X_0$ intersects $\mathbf{Z}_{\mathbf{A}, \mathbf{P}, 0}$ in $\mathcal{D}_{\mathcal{A}_j}^{\mathbb{R}}$ real points, where \mathcal{A}_j is the index of the inclusion of lattices defined in Proposition 4.16. Thus, there are $\mathcal{D}_{\mathcal{A}_j}^{\mathbb{R}}$ choices of real marked points mapping to $\mathbf{Z}_{\mathbf{A}, \mathbf{P}, 0}$. Moreover, by Theorem 5.1, there are $w^{\mathbb{R}}(\Gamma, \mathbf{E})$ pairwise nonisomorphic ways to lift the real stable map φ_0 to a real stable log map $\varphi_0: C_0 \rightarrow X_0$. Therefore, $N_{(g, \Delta, \mathbf{A}, \mathbf{P})}^{\mathbb{R}\text{-trop}}$ is the number of real stable log maps to X_0 lifting maximally degenerate stable maps $\varphi_0: \underline{C}_0 \rightarrow X_0$ passing through the constraints $\mathbf{Z}_{\mathbf{A}, \mathbf{P}, 0}$.

By Theorem 6.3, each real stable log map $\varphi_0: C_0 \rightarrow X_0$ obtained as real log lift of a maximally degenerate stable map $\varphi_0: \underline{C}_0 \rightarrow X_0$ passing through the constraints $\mathbf{Z}_{\mathbf{A}, \mathbf{P}, 0}$ deforms in a unique way in family of real stable log maps $\varphi_{\infty}: C_{\infty} \rightarrow \mathcal{X}$ over $\text{Spec } \mathbb{C}[[t]]$ passing through the constraints $\mathcal{Z}_{\mathbf{A}, \mathbf{P}}$.

Conversely, we have to show that every real stable log map $\varphi: C \rightarrow \mathcal{X} \times_{\mathbb{C}[[t]]} \mathbb{C}((t))$ defined over the point $\text{Spec } \mathbb{C}((t))$ (with trivial log structure) and passing through the constraints $\mathcal{Z}_{\mathbf{A}, \mathbf{P}} \times_{\mathbb{C}[[t]]} \mathbb{C}((t))$ is obtained by deformation of a real maximally degenerate stable log map $\varphi_0: C_0 \rightarrow X_0$ defined over the standard log point. Without the reality condition, it is proved in the proof of [34, Theorem 8.3]. The real case follows immediately: a limit of real stable log maps is real and so if $\varphi: C \rightarrow \mathcal{X} \times_{\mathbb{C}[[t]]} \mathbb{C}((t))$ is a deformation of $\varphi_0: C_0 \rightarrow X_0$, then $\varphi_0: C_0 \rightarrow X_0$ is automatically a real stable log map.

Using the general theory of basic stable log maps developed in [22] (see Remark 3.15), we give a proof that φ is a deformation of some φ_0 which is distinct and more conceptual than the one given in the proof of [34, Theorem 8.3] (which relies on the full [34, Section 6]). By the stable reduction theorem for basic stable log maps ([22, Theorem 4.1]), after a finite base change, there exists an extension of $\varphi: C \rightarrow \mathcal{X} \times_{\mathbb{C}[[t]]} \mathbb{C}((t))$ into a basic stable log map $\bar{\varphi}: \bar{C} \rightarrow \mathcal{X}$ over $\text{Spec } \mathbb{C}[[t]]$ endowed with a possibly non-trivial log structure, and passing through the constraints $\mathcal{Z}_{\mathbf{A}, \mathbf{P}}$. By restriction to the special fiber, we get a basic stable log map $\varphi_0: C_0 \rightarrow X_0$ over $\text{Spec } \mathbb{C}$ endowed with some log structure. Then, by the construction of a tropicalization of stable log maps (see [22, Appendix B], [5, Construction 8.3]) the tropicalization of $\varphi_0: C_0 \rightarrow X_0$ is a ℓ -marked tropical curve of degree Δ matching \mathbf{A} , that is an element of $\mathfrak{T}_{g, \ell, \Delta}(\mathbf{A})$. As by construction, the polyhedral decomposition defining our toric degeneration contains all the tropical curves in $\mathfrak{T}_{g, \ell, \Delta}(\mathbf{A})$, it follows that the stable map underlying $\varphi_0: C_0 \rightarrow X_0$ is maximally degenerate, that the basic monoid is equal to \mathbb{N} and so that φ_0 is defined over the standard log point O_0 . □

8. Tropical Welschinger signs in dimension two

In this section we set $n = 2$ and we define tropical Welschinger multiplicities for trivalent tropical curves in $M_{\mathbb{R}} = \mathbb{R}^2$, following [27, Section 2.5.1], [32], [37].

8.1. Tropical Welschinger signs and the dual subdivision

DEFINITION 8.1. — *Let $h: \Gamma \rightarrow \mathbb{R}^2$ be a trivalent tropical curve and let V be a vertex of Γ . The dual triangle Δ_V is the cell associated to V in the dual subdivision of $h: \Gamma \rightarrow \mathbb{R}^2$ (see [27, Section 3.2]). Explicitly, Δ_V is the integral triangle with inner normals given by the direction vectors of the edges adjacent to V , and with sides of integral length equal to the weight of the corresponding edge.*

DEFINITION 8.2. — *Let $h: \Gamma \rightarrow \mathbb{R}^2$ be a trivalent tropical curve and let V be a vertex of Γ . Let Δ_V be the triangle dual to V . We define*

$$(8.1) \quad \text{Mult}_{\mathbb{R}}(V) := (-1)^{I_{\Delta_V}},$$

where I_{Δ_V} is the number of integral points in the interior of Δ_V .

DEFINITION 8.3. — *Let $h: \Gamma \rightarrow \mathbb{R}^2$ be a trivalent tropical curve. We define*

$$(8.2) \quad \text{Mult}_{\mathbb{R}}(h) := \begin{cases} 0 & \text{if } \Gamma \text{ contains a bounded edge of even weight} \\ \prod_{V \in \Gamma^{[0]}} \text{Mult}_{\mathbb{R}}(V) & \text{else.} \end{cases}$$

8.2. Tropical Welschinger signs: reformulation

First recall that given a trivalent tropical curve $h: \Gamma \rightarrow \mathbb{R}^2$, the *complex vertex multiplicity* is defined as follows [32]. For each vertex $V \in \Gamma^{[0]}$, consider two different edges E_1, E_2 emanating from V and set

$$(8.3) \quad \text{Mult}(V) := w(E_1) \cdot w(E_2) \cdot |\det(u_{(V,E_1)}, u_{(V,E_2)})|$$

where $w(E_i)$ is the weight on the edge E_i , and $u_{(V,E_i)}$ are primitive integral vectors emanating from $h(V)$ in the direction of $h(E_i)$. By the balancing condition (2.1) this number does not depend on the choices of E_1 and E_2 .

LEMMA 8.4. — *Let $h: \Gamma \rightarrow \mathbb{R}^2$ be a trivalent tropical curve and let V be a vertex of Γ . Let E_1, E_2, E_3 be the edges of Γ emanating from V with weights $w(E_1), w(E_2), w(E_3)$. Then*

$$(8.4) \quad \text{Mult}_{\mathbb{R}}(V) = (-1)^{\frac{1}{2}(\text{Mult}(V) - w(E_1) - w(E_2) - w(E_3)) + 1}.$$

Proof. — As the complex vertex multiplicity $\text{Mult}(V)$ defined as in (8.3) is twice the area of Δ_V and $w(E_1) + w(E_2) + w(E_3)$ is the number of integral points on the boundary of Δ_V , we have

$$I_{\Delta_V} = \frac{1}{2}(\text{Mult}(V) - w(E_1) - w(E_2) - w(E_3)) + 1$$

by Pick’s formula. Hence, the result follows from the definition of $\text{Mult}_{\mathbb{R}}(V)$. □

LEMMA 8.5. — *Let $h: \Gamma \rightarrow \mathbb{R}^2$ be a trivalent tropical curve and let V be a vertex of Γ . Let E_1, E_2, E_3 be the edges of Γ emanating from V with weights $w(E_1), w(E_2), w(E_3)$. If the weights $w(E_1), w(E_2), w(E_3)$ are odd, then the complex multiplicity $\text{Mult}(V)$ defined as in (8.3) is also odd.*

Proof. — For $i \in \{1, 2, 3\}$, let $u_{(V, E_i)}$ be the primitive integral vector emanating from $h(V)$ in the direction $h(E_i)$. Set

$$m := \det(u_{(V, E_1)}, u_{(V, E_2)}).$$

Using the action of $SL(2, \mathbb{Z})$ on \mathbb{Z}^2 , we can assume that $u_{(V, E_1)} = (1, 0)$ and $u_{(V, E_2)} = (a, m)$ with a coprime to m .

By (8.3), we have $\text{Mult}(V) = w(E_1)w(E_2)|m|$. As we are assuming that $w(E_1)$ and $w(E_2)$ are odd, it is enough to show that m is odd to prove that $\text{Mult}(V)$ is odd. We assume by contradiction that m is even. Then, a is odd since $u_{(V, E_2)}$ is primitive. By the tropical balancing condition (2.1), we have

$$w(E_3)u_{(V, E_3)} = -w(E_1)u_{(V, E_1)} - w(E_2)u_{(V, E_2)} = -(w(E_1) + aw(E_2), m).$$

As $w(E_1), w(E_2), a$ are odd, we deduce that $w(E_1) + aw(E_2)$ is even, and as we are assuming that m is also even, that $w(E_3)u_{(V, E_3)}$ is divisible by 2 in \mathbb{Z}^2 . But as $u_{(V, E_3)}$ is primitive in \mathbb{Z}^2 , this is only possible if $w(E_3)$ is even, contradiction. □

8.3. Tropical Welschinger signs à la Mikhalkin

In [32, Definition 7.19], Mikhalkin only considers tropical curves with unbounded edges of weight 1 and uses a slightly different looking version of the tropical Welschinger sign.

DEFINITION 8.6. — *Let V be a trivalent vertex with complex multiplicity $\text{Mult}(V)$. Then we define*

$$(8.5) \quad \text{Mult}_{\mathbb{R}}^M(V) := \begin{cases} (-1)^{\frac{\text{Mult}(V)-1}{2}} & \text{if } \text{Mult}(V) \text{ is odd} \\ 0 & \text{otherwise.} \end{cases}$$

DEFINITION 8.7. — *Let $h: \Gamma \rightarrow \mathbb{R}^2$ be a trivalent tropical curve. We define*

$$(8.6) \quad \text{Mult}_{\mathbb{R}}^M(h) = \prod_V \text{Mult}_{\mathbb{R}}^M(V).$$

LEMMA 8.8. — *Let $h: \Gamma \rightarrow \mathbb{R}^2$ be a trivalent tropical curve. Assume that all the weights of unbounded edges of Γ are odd. If the number of unbounded edges of h with weights congruent to $3 \pmod 4$ is even, then*

$$\text{Mult}_{\mathbb{R}}(h) = \text{Mult}_{\mathbb{R}}^M(h).$$

If the number of unbounded edges of h with weights congruent to $3 \pmod 4$ is odd, then

$$\text{Mult}_{\mathbb{R}}(h) = -\text{Mult}_{\mathbb{R}}^M(h).$$

Proof. — If Γ contains a bounded edge of even weight, then $\text{Mult}_{\mathbb{R}}(h) = 0$ by (8.2), and Γ contains a vertex of even complex multiplicity by (8.3), and so also $\text{Mult}_{\mathbb{R}}^M(h) = 0$ by (8.5)–(8.6).

Hence, we can assume that all bounded edges of Γ have odd weight for the remainder of the proof. By assumption, all unbounded weights of Γ are odd, so we are now assuming that all edges of Γ have odd weights. As every bounded edge is adjacent to two vertices whereas an unbounded is adjacent to only one vertex, we deduce from (8.4) that

$$\text{Mult}_{\mathbb{R}}(h) = \prod_{V \in \Gamma^{[0]}} (-1)^{\frac{\text{Mult}(V)}{2}+1} \prod_{E \in \Gamma^{[1]} \setminus \Gamma_{\infty}^{[1]}} (-1)^{-w(E)} \prod_{E \in \Gamma_{\infty}^{[1]}} (-1)^{-\frac{w(E)}{2}}.$$

On the other hand, as we are assuming that all edges of Γ have odd weight, we deduce from Lemma 8.5 that all vertices of Γ of odd complex multiplicity and so

$$\text{Mult}_{\mathbb{R}}^M(h) = \prod_{V \in \Gamma^{[0]}} (-1)^{\frac{\text{Mult}(V)-1}{2}}$$

by (8.5)–(8.6). Therefore, $\text{Mult}_{\mathbb{R}}(h)$ and $\prod_V \text{Mult}_{\mathbb{R}}^M(V)$ differ by the sign given by -1 to the power

$$\begin{aligned} & \frac{3}{2} \#\Gamma^{[0]} - \#\{\Gamma^{[1]} \setminus \Gamma_{\infty}^{[1]}\} - \frac{1}{2} \#\Gamma_{\infty}^{[1]} + \#\{E \in \Gamma_{\infty}^{[1]} \mid w(E) = 3 \pmod 4\} \\ &= \frac{1}{2} (3\#\Gamma^{[0]} - 2\#\{\Gamma^{[1]} \setminus \Gamma_{\infty}^{[1]}\} - \#\Gamma_{\infty}^{[1]} + \#\{E \in \Gamma_{\infty}^{[1]} \mid w(E) = 3 \pmod 4\}). \end{aligned}$$

As Γ is a trivalent graph, we have

$$3\#\Gamma^{[0]} = 2\#\left(\Gamma^{[1]} \setminus \Gamma_\infty^{[1]}\right) + \#\Gamma_\infty^{[1]},$$

and so $\text{Mult}_\mathbb{R}(h)$ and $\prod_V \text{Mult}_\mathbb{R}^M(V)$ differ by the sign given by -1 to the power

$$\#\{E \in \Gamma_\infty^{[1]} \mid w(E) = 3 \pmod 4\}. \quad \square$$

9. Log Welschinger signs and invariance in dimension two

In this section, we specialize the setup of Section 7 to $n = 2$ and zero-dimensional constraints \mathbf{A} . In Section 9.1, we show that for $t \in \mathbb{R}^\times$ sufficiently close to 0 and for every $(\varphi_t: C_t \rightarrow X_t)$ in $M_{(g,\Delta,\mathbf{A},\mathbf{P}),t}^{\mathbb{R}-\log}$, all the singularities of the curve $\varphi_t(C_t)$ are nodes. In Section 9.2, we introduce counts of φ_t with Welschinger signs, defined by the real nature of the nodes of $\varphi_t(C_t)$. In Sections 9.3–9.4, we study explicitly the real nature of the nodes of $\varphi_t(C_t)$. We deduce from this study Theorem 9.8 (=Theorem 1.2) in Section 9.5. In Section 9.6, we discuss the relation with the symplectically defined Welschinger invariants.

9.1. Nodes as only singularities

We show in Proposition 9.2 below that for t sufficiently close to 0, all the curves $\varphi_t(C_t)$ for $(\varphi_t: C_t \rightarrow X_t)$ in $M_{(g,\Delta,\mathbf{A},\mathbf{P}),t}^{\mathbb{R}-\log}$ are nodal. We start by showing that the image curve of a line in a toric surface is nodal.

PROPOSITION 9.1. — *Let X be a complete toric surface and let*

$$(\mathbf{u}, \mathbf{w}) = ((u_i)_{1 \leq i \leq 3}, (w_i)_{1 \leq i \leq 3}) \in M^3 \times (\mathbb{N} \setminus \{0\})^3$$

with u_i primitive and $\sum_{i=1}^3 w_i u_i = 0$. Let $\varphi: \mathbb{P}^1 \rightarrow X$ be a line in X with type (\mathbf{u}, \mathbf{w}) (see Definition 4.6). Then, all the singularities of the image curve $\varphi(\mathbb{P}^1)$ are nodes, that is ordinary double points, and are all contained in the 2-dimensional torus orbit of X .

Proof. — Without loss of generality, we can assume that X is the complete toric surface whose toric fan is given by the rays $\mathbb{Q}u_i$. Let D_1, D_2, D_3 be the toric divisors of X corresponding to the rays $\mathbb{Q}u_1, \mathbb{Q}u_2, \mathbb{Q}u_3$.

We will first prove that $\varphi(\mathbb{P}^1)$ does not have unibranch singularities. As in the proof of Lemma 4.9, one can describe a real line $\varphi: \mathbb{P}^1 \rightarrow X$ in X of type (\mathbf{u}, \mathbf{w}) by

$$(9.1) \quad \varphi^*(z^n) = \chi_\varphi(n) \prod_{i=1}^3 (y - y(q_i))^{(w_i u_i, n)}$$

for every $n \in N$, where χ_φ is a real character of N , y the unique real coordinate on \mathbb{P}^1 such that at the points q_1, q_2, q_3 of \mathbb{P}^1 mapped by φ on D_1, D_2, D_3 , we have $y(q_1) = -1, y(q_2) = 0, y(q_3) = 1$.

Applying (9.1) to $n = \det(-, w_1 u_1)$ and using $\sum_{i=1}^3 w_i u_i = 0$, we obtain

$$\varphi^*(z^{\det(-, w_1 u_1)}) = \chi_\varphi(n) \left(\frac{y - 1}{y} \right)^\mu,$$

where $\mu := w_1 w_2 \det(u_1, u_2) = -w_3 w_2 \det(u_3, u_2)$. Therefore, if $\mu > 0$,

$$\frac{d}{dy} \varphi^*(z^{\det(-, w_1 u_1)}) \neq 0$$

for $y \neq 1$ and so $\varphi(\mathbb{P}^1)$ does not have a unibranch singularity for $y \neq 1$. If $\mu < 0$, $\frac{d}{dy} \varphi^*(z^{\det(-, w_1 u_1)}) \neq 0$ for $y \neq 0$ and so $\varphi(\mathbb{P}^1)$ does not have a unibranch singularity for $y \neq 0$. Similarly applying (9.1) to $n = \det(-, w_2 u_2)$ and $n = \det(-, w_3 u_3)$, we obtain that $\varphi(\mathbb{P}^1)$ does not have unibranch singularities at all.

Therefore, it remains to study multibranch singularities of $\varphi(C)$, created by distinct points of C mapped by φ to the same point. By the Definition 4.6 of a line, there is a unique point of \mathbb{P}^1 mapped by φ to each intersection point of $\varphi(\mathbb{P}^1)$ with the toric divisors of X , and so multibranch singularities of $\varphi(\mathbb{P}^1)$ are necessarily contained in the 2-dimensional torus orbit of X . Our goal is to show that all multibranch singularities of $\varphi(\mathbb{P}^1)$ are ordinary double points, that is double points with distinct tangent lines.

By [34, Proposition 5.5] (or see the proof of Lemma 4.9 for a different argument), the natural action of $M \otimes_{\mathbb{Z}} \mathbb{C}^\times$ on the space of lines in X of type (\mathbf{u}, \mathbf{w}) is transitive. Therefore, it is enough to prove the result for one specific line in X of type (\mathbf{u}, \mathbf{w}) . Let $\psi: \mathbb{Z}^2 \rightarrow \mathbb{Z}^2$ be the map of lattices such that $(1, 0) \mapsto w_1 u_1, (0, 1) \mapsto w_2 u_2, (-1, -1) \mapsto w_3 u_3$, and let $\psi_{\mathbb{C}}: (\mathbb{C}^\times)^2 \mapsto (\mathbb{C}^\times)^2$ be the corresponding map of complex tori, which can be naturally compactified in a map $\bar{\psi}_{\mathbb{C}}: \mathbb{P}^2 \rightarrow X$ of toric varieties. Let ι be the linear embedding $\mathbb{P}^1 \rightarrow \mathbb{P}^2$ of image the closure of $\{(x, y) \in (\mathbb{C}^\times)^2 \mid 1 + x + y = 0\}$. We will study the line $\varphi: \mathbb{P}^1 \rightarrow X$ of type (\mathbf{u}, \mathbf{w}) defined by the composition $\varphi := \bar{\psi}_{\mathbb{C}} \circ \iota$.

We prove that multibranch singularities of $\varphi(\mathbb{P}^1)$ are double points. We have to prove that 3 distinct points of \mathbb{P}^1 cannot be mapped by φ on the

same point of X . It is enough to show that there are at most two points $(x_1, y_1), (x_2, y_2) \in (\mathbb{C}^\times)^2$ on the line of equation $1 + x + y = 0$ and differing multiplicatively by an element of the kernel of $\Psi_{\mathbb{C}}$. As $\Psi_{\mathbb{C}}$ is a monomial map, coordinates of elements in the kernel of $\Psi_{\mathbb{C}}$ are roots of unity, and so it is enough to show that for given $(x_1, y_1) \in (\mathbb{C}^\times)^2$ on the line of equation $1 + x + y = 0$, there is at most another point $(x_2, y_2) \in (\mathbb{C}^\times)^2$ on the line with $|x_2| = |x_1|, |y_2| = |y_1|$. Writing $x_2 = \zeta x_1$ and $y_2 = \xi y_1$ with $|\zeta| = |\xi| = 1, \zeta \neq 1, \xi \neq 1$, we are looking for ζ and ξ such that $1 + \zeta x_1 + \xi y_1 = 0$. We can set $\xi = -\frac{1}{y_1}(1 + \zeta x_1)$ only if $|\frac{1}{y_1}(1 + \zeta x_1)|^2 = 1$, that is $\frac{1}{|y_1|^2}(1 + \zeta x_1)(1 + \zeta^{-1}\bar{x}_1) = 1$, which is a non-trivial degree two equation in ζ , so with at most two roots. As $1 + x_1 + y_1 = 0, \zeta = 1$ is a root and so there is at most one root ζ with $\zeta \neq 1$.

It remains to show that double points of $\varphi(\mathbb{P}^1)$ have distinct tangent lines. The map $\Psi_{\mathbb{C}}: (\mathbb{C}^\times)^2 \rightarrow (\mathbb{C}^\times)^2$ is of the form $(x, y) \mapsto (x' = x^a y^b, y' = x^c y^d)$ for some $a, b, c, d \in \mathbb{Z}$ with $ad - bc \neq 0$. We compute the differential of $\Psi_{\mathbb{C}}$ restricted to the line $1 + x + y = 0$. We have

$$\begin{aligned} dx' &= ax^{a-1}y^b dx + bx^a y^{b-1} dy = \frac{a}{x}x' dx + \frac{b}{y}x' dy \\ dy' &= cx^{c-1}y^d dx + dx^c y^{d-1} dy = \frac{c}{x}y' dx + \frac{d}{y}y' dy. \end{aligned}$$

As $1 + x + y = 0$, we have $dx = -dy$ so

$$\begin{aligned} dx' &= \left(\frac{a}{x} - \frac{b}{y}\right)x' dx \\ dy' &= \left(\frac{c}{x} - \frac{d}{y}\right)y' dx. \end{aligned}$$

Therefore, the equation of the tangent at the point $(x', y') = \Psi_{\mathbb{C}}(x, y)$ is

$$\left(\frac{c}{x} - \frac{d}{y}\right)y' dx' + \left(\frac{a}{x} - \frac{b}{y}\right)x' dy' = 0.$$

Let us assume that we have a double point formed by two distinct points (x_1, y_1) and (x_2, y_2) on the line $1 + x + y = 0$ mapped by $\Psi_{\mathbb{C}}$ to the same point $(x'_1, y'_1) = (x'_2, y'_2)$. If the tangent lines to $\varphi(\mathbb{P}^1)$ at the nodes along the two branches coincide, then

$$\frac{ay_1 - bx_1}{cy_1 - dx_1} = \frac{ay_2 - bx_2}{cy_2 - dx_2}.$$

It follows that $(ad - bc)(x_1 y_2 - x_2 y_1) = 0$, so $x_1 y_2 = x_2 y_1$. As $y_2 = -1 - x_2$ and $y_1 = -1 - x_1$, we obtain $x_1(1 + x_2) = x_2(1 + x_1)$ and so $x_1 = x_2$, and $y_1 = y_2$, in contradiction with the assumption that (x_1, y_1) and (x_2, y_2) are distinct. □

PROPOSITION 9.2. — For every $t \in \mathbb{A}^1 \setminus \{0\}$ sufficiently close to 0 and for every $(\varphi_t: C_t \rightarrow X_t)$ in $M_{(g,\Delta,\mathbf{A},\mathbf{P}),t}^{\mathbb{R}\text{-log}}$, the only singularities of the curves $\varphi_t(C_t)$ are nodes.

Proof. — The map $(\varphi_t: C_t \rightarrow X_t)$ is a deformation of $(\varphi_0: C_0 \rightarrow X_0)$, so $\varphi_t(C_t)$ is a deformation of $\varphi_0(C_0)$. As φ_0 is maximally degenerate, it follows from Proposition 9.1 that $\varphi_0(C_0)$ is a nodal curve. Therefore, $\varphi_t(C_t)$ is nodal for t sufficiently close to 0. As $M_{(g,\Delta,\mathbf{A},\mathbf{P}),t}^{\mathbb{R}\text{-log}}$ is finite, this holds for all φ_t for t sufficiently close to 0. □

9.2. Log Welschinger signs

We first recall the classification of possible types of nodes of a real nodal curve. These nodes can be of one of the following possible types.

- (i) *Elliptic (isolated) nodes*: These are real nodes $x^2 + y^2 = 0$ for a choice of local real coordinates (x, y) .
- (ii) *Hyperbolic (non-isolated) nodes*: These are real nodes, with local equation $x^2 - y^2 = 0$ for a choice of local real coordinates (x, y) .
- (iii) *Imaginary nodes*: These are nodes of C that are at non-real points. Such nodes come in complex conjugate pairs.

DEFINITION 9.3. — Let $\varphi: C \rightarrow X$ be a real stable log map in a toric surface X with $\varphi(C)$ nodal. The log Welschinger sign of φ is

$$(9.2) \qquad \mathcal{W}^{\text{log}}(\varphi) := (-1)^{m(\varphi)}$$

where $m(\varphi)$ is the total number of elliptic (isolated) nodes of $\varphi(C)$.

Let $\varphi_t: C_t \rightarrow X_t$ be an element of $M_{(g,\Delta,\mathbf{A},\mathbf{P}),t}^{\mathbb{R}\text{-log}}$. By Proposition 9.2, for $t \in \mathbb{A}^1(\mathbb{R}) \setminus \{0\} \simeq \mathbb{R}^\times$ sufficiently close to 0, $\varphi_t(C_t)$ is a real nodal curve. We will study in the next sections the real types of these nodes. As $\varphi_t: C_t \rightarrow X_t$ is a deformation of $\varphi_0: C_0 \rightarrow X_0$, the nodes of $\varphi_t(C_t)$ fall into one of the two following cases, see Figure 1.1.

- (a) Nodes obtained by local isomorphic deformations of nodes of $\varphi_0(C_0)$ contained in the smooth locus of X_0 .
- (b) Nodes obtained by the non-trivial deformation of a node of $\varphi_0(C_0)$ contained in the double locus of X_0 .

We study nodes of type (b) in Section 9.3 and nodes of type (a) in Section 9.4.

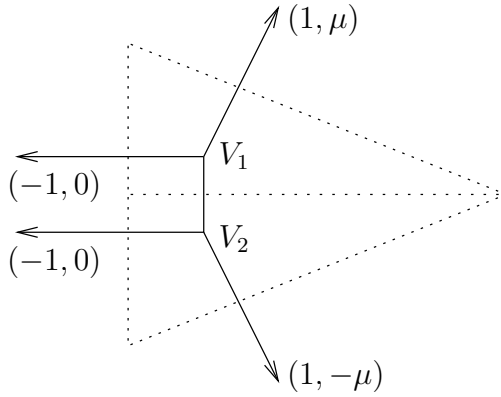

Figure 9.1. The tropical image around a nodal point after a suitable blow-up and base-change.

9.3. New nodes generated during the deformation

Let $\varphi_0: C_0 \rightarrow X_0$ be a maximally degenerate real stable log map, with associated tropical curve $(h: \Gamma \rightarrow M_{\mathbb{R}} \simeq \mathbb{R}^2) \in \mathfrak{T}_{g,\ell,\Delta}(\mathbf{A})$. Let $(\varphi_t: C_t \rightarrow X_t) \in M_{(g,\Delta,\mathbf{A},\mathbf{P}),t}^{\mathbb{R}\text{-log}}$ be the deformation of φ_0 for $t \in \mathbb{A}^1(\mathbb{R}) \setminus \{0\} \simeq \mathbb{R}^\times$. We focus on a node P of C_0 , corresponding to an edge E of Γ of weight $\mu := w(E)$, and on the node of $\varphi_t(C_t)$ which are contracted to $\varphi_0(P)$ at $t = 0$. There are $\mu - 1$ such nodes, corresponding to the $\mu - 1$ interior integral points on the edge dual to E in the subdivision dual to Γ . In this section, we analyze the real type of these nodes. The following Lemma will allow us in the proof of Theorem 9.5 to reduce the general case to a specific situation which can be handled explicitly.

LEMMA 9.4. — *Let $\varphi_0: C_0 \rightarrow X_0$ be a real maximally degenerate stable log map with associated tropical curve $(h: \Gamma \rightarrow M_{\mathbb{R}} \cong \mathbb{R}^2) \in \mathfrak{T}_{g,\ell,\Delta}(\mathbf{A})$, and let $P \in C_0$ be a nodal point corresponding to an edge $E \in \Gamma^{[1]}$, of weight $\mu := w(E)$. Denote the vertices adjacent to E by $\partial E = \{V_1, V_2\}$, and let $\{E, E_i, E'_i\}$ be the set of edges adjacent to V_i . Then, by a suitable base change, a blow-up and a further degeneration of X_0 , we can assume that*

$$u_{V_1, E_1} = (-1, 0), \quad u_{V_1, E'_1} = (1, \mu), \quad u_{V_2, E_2} = (-1, 0), \quad u_{V_2, E'_2} = (1, -\mu),$$

as illustrated in Figure 9.1.

Proof. — Since φ_0 is torically transverse (Definition 4.1), the image $h(E)$ of the edge E is a segment of the polyhedral decomposition \mathcal{P} . Since the

question is local near $\varphi_0(P)$ in X_0 and near $h(E)$ in $M_{\mathbb{R}}$, we can assume by a local rescaling of M that the affine integral length of $h(E)$ equals μ . Let X_1 and X_2 be the irreducible components of the central fiber of the toric degeneration corresponding to the vertices $h(V_1)$ and $h(V_2)$ of the polyhedral decomposition. The surfaces X_1 and X_2 intersect along a divisor X_E corresponding to the edge $h(E)$ of the polyhedral decomposition. Let C_1 and C_2 be the two components of C mapped by φ to X_1 and X_2 respectively. Let $p \in C$ be node of C given by the intersection point of C_1 and C_2 . We have $\varphi(p) \in X_E$.

Étale locally near $\varphi(p)$, the total space \mathcal{X} of the toric degeneration can be described as $\text{Spec } \mathbb{C}[x, y, \gamma, t]/(xy - t^\mu)$, where $\varphi(p)$ is the point $x = y = t = \gamma = 0$, γ is a coordinate along X_E , X_1 is locally defined by $x = 0$ and X_2 is locally defined by $y = 0$, such that $h(C_1)$ is locally defined by an equation of the form $x = \gamma^\mu$ and $h(C_2)$ is locally defined by an equation of the form $y = \gamma^\mu$. Note that because γ is centered around the point $\varphi(p)$, which is in the 1-dimensional torus orbit of X_E , γ is not induced by a toric monomial.

We perform the base change $t = s^2$. The resulting total space can be locally described as $\text{Spec } \mathbb{C}[x, y, \gamma, s]/(xy - s^{2\mu})$. We then blow-up the ideal

$$(x, y, s^\mu, s^{\mu-1}\gamma, \dots, s\gamma^{\mu-1}, \gamma^\mu)$$

of $\text{Spec } \mathbb{C}[x, y, \gamma, s]/(xy - s^{2\mu})$, that is a non-reduced version of the point $\varphi(p)$ defined by $x = y = \gamma = s = 0$. We denote by $\tilde{\mathcal{X}}$ the resulting total space, and $\pi: \tilde{\mathcal{X}} \rightarrow \mathcal{X}$ the blow-up morphism composed with the base change morphism. Note that because $\varphi(p)$ is not a torus fixed point of \mathcal{X} , $\tilde{\mathcal{X}}$ is not toric in general.

We show that the exceptional divisor S is isomorphic to the toric surface whose fan is dual to the triangle with vertices $(0, 1)$, $(0, -1)$, $(0, \mu)$. As the ideal $(x, y, s^\mu, s^{\mu-1}\gamma, \dots, s\gamma^{\mu-1}, \gamma^\mu)$ of $\text{Spec } \mathbb{C}[x, y, \gamma, s]/(xy - s^{2\mu})$ is monomial, the blow-up can be studied using the tools of toric geometry. The moment cone of $\text{Spec } \mathbb{C}[x, y, \gamma, s]/(xy - s^{2\mu})$ is isomorphic to the cone \mathcal{C} in \mathbb{Z}^3 generated by $(\mu, 1, 0)$, $(\mu, -1, 0)$, $(0, 0, 1)$, with $(\mu, 1, 0)$ corresponding to x , $(\mu, -1, 0)$ corresponding to y , $(0, 0, 1)$ corresponding to γ and $(1, 0, 0)$ corresponding to s . The linear relation

$$(\mu, 1, 0) + (\mu, -1, 0) = 2\mu(1, 0, 0)$$

corresponds to the relation $xy = s^{2\mu}$. The monomials

$$x, y, s^\mu, s^{\mu-1}\gamma, \dots, s\gamma^{\mu-1}, \gamma^\mu$$

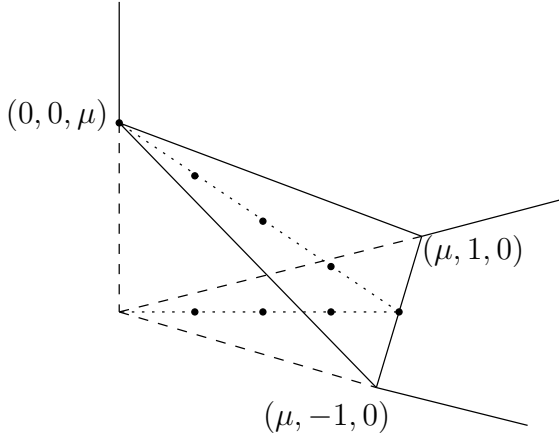

Figure 9.2. Toric polytope description of the blow-up

exactly correspond to the integral points of the intersection of \mathcal{C} with the integral plane P in \mathbb{Z}^3 passing through the three points $(\mu, 1, 0)$, $(\mu, -1, 0)$, $(0, 0, 1)$. Therefore, by standard toric geometry, blowing-up the ideal

$$(x, y, s^\mu, s^{\mu-1}\gamma, \dots, s\gamma^{\mu-1}, \gamma^\mu)$$

corresponds to chopping off \mathcal{C} along $\mathcal{C} \cap P$, and the cone of the exceptional divisor is given by the triangle $\mathcal{C} \cap P$ inside P , see Figure 9.3. The map $(\mu, 1, 0) \mapsto (0, 1)$, $(\mu, -1, 0) \mapsto (0, -1)$, $(0, 0, \mu) \mapsto (\mu, 0)$ induces an affine integral isomorphism between $\mathcal{C} \cap P$ in P and the triangle with vertices $(0, 1)$, $(0, -1)$, $(\mu, 0)$ in \mathbb{Z}^2 .

It follows that the fan of S consists of the three rays generated by $(-1, 0)$, $(1, \mu)$, and $(1, -\mu)$. Let D_1 be the toric divisor of S dual to the ray generated by $(1, \mu)$ and let D_2 be the toric divisor of S dual to the ray generated by $(1, -\mu)$. If we continue to denote by X_1 and X_2 the strict transforms of X_1 and X_2 in $\tilde{\mathcal{X}}$, then $X_1 \cap S = D_1$ and $X_2 \cap S = D_2$.

As π is not a toric blowup, S does not come naturally with a toric structure: there are natural divisors D_1 and D_2 but no canonical choice of divisor D_3 dual to the ray generated by $(-1, 0)$. The blow-up geometry $\tilde{\mathcal{X}}$ comes with a natural log smooth log structure over \mathbb{A}^1 . The corresponding central fiber \tilde{X}_0 is log smooth over the standard log point. In restriction to S , the morphism to the standard log point is strict away from $D_1 \cup D_2$.

The stable log map $\varphi: C \rightarrow X_0$ lifts to a stable log map $\tilde{\varphi}: \tilde{C} \rightarrow \tilde{X}_0$, where \tilde{C} is obtained from C by replacing the node p by a new \mathbb{P}^1 -component C_S , meeting the rest of \tilde{C} in two nodes p_1, p_2 , and $\tilde{\varphi}(C_S) \subset S$, $\tilde{\varphi}(p_1) \in$

$D_1, \tilde{\varphi}(p_2) \in D_2$. By construction of the blow-up, the curve $\tilde{\varphi}(C_S)$ has contact orders 1 with D_1 and D_2 at the points $\tilde{\varphi}(p_1)$ and $\tilde{\varphi}(p_2)$, and so the smoothing of the two nodes p_1 and p_2 of \tilde{C} does not create new nodes in the image curve. Therefore, the nodes of the image curve coming from the smoothing of the node p of the curve C in X_0 can be identified with the nodes of the image curve $\tilde{\varphi}(C_S)$ in $S \subset \tilde{X}_0$.

It follows that the study of the real nature of the nodes of the image curve coming from the smoothing of the node p of C is reduced to the study of the real nature of the nodes of the image of $\tilde{\varphi}(C_S)$. In order to do that, we complete $(S, D_1 \cup D_2)$ into a general toric structure $(S, D_1 \cup D_2 \cup D_3)$ and we pick a toric degeneration of S defined by the polyhedral decomposition given by a tropical curve $h_S: \Gamma_S \rightarrow M_{\mathbb{R}}$ with two vertices V_1, V_2 , one bounded edge of weight μ connecting V_1, V_2 , two unbounded edges of directions $(-1, 0)$ and $(1, \mu)$ with weight 1 attached to V_1 , and two unbounded edges of directions $(-1, 0)$ and $(1, -\mu)$ with weight 1 attached to V_2 . In such degeneration, the curve $\tilde{\varphi}|_{C_S}: C_S \rightarrow S$ degenerates into a curve with tropicalization $h_S: \Gamma_S \rightarrow M_{\mathbb{R}}$. Therefore, we have reduced the study of the nodes of the image curve produced by the smoothing of a node corresponding to an edge of weight μ in a general tropical curve to the study of the nodes of the image curve produced by the smoothing of a node corresponding to the edge of weight μ in the tropical curve $h_S: \Gamma_S \rightarrow M_{\mathbb{R}}$, and this ends the proof of Lemma 9.4. □

We remark that the proof of Lemma 9.4 is a version of the shift operation introduced by Shustin in [37, Section 3.5]. The reformulation of the shift operation in terms of blow-up is also discussed by Shustin and Tyomkin in [39, 40].

THEOREM 9.5. — *Let $\varphi_0: C_0 \rightarrow X_0$ be a real maximally degenerate stable log map with associated tropical curve $(h: \Gamma \rightarrow M_{\mathbb{R}} \cong \mathbb{R}^2) \in \mathfrak{T}_{g,\ell,\Delta}(\mathbf{A})$. Let $P \in C_0$ be a node corresponding to an edge $E \in \Gamma^{[1]}$ of weight $\mu := w(E)$, and let e be the integral affine length of $h(E)$. Let ζ be the real root of unity specifying the real log structure of C_0 at P . Then, the real types of the $\mu - 1$ nodes in the image $\varphi(C)$ of the deformation $\varphi: C \rightarrow X$ of φ_0 over $t \in \mathbb{A}^1(\mathbb{R}) \setminus \{0\} \simeq \mathbb{R}^\times$ and which have limit $\varphi_0(P)$ at $t = 0$, are as follows:*

- *If μ is odd (and so necessarily $\zeta = 1$), then all the $\mu - 1$ nodes of $\varphi(C)$ are elliptic.*
- *If μ is even and ζ and $t^{\frac{e}{\mu}}$ have the same sign, then all the $\mu - 1$ created nodes of $\varphi(C)$ are elliptic.*

- If μ is even and ζ and $t^{\frac{e}{\mu}}$ have opposite signs, then one of the nodes of $\varphi(C)$ is hyperbolic and the $\mu - 2$ others form $\frac{\mu - 2}{2}$ pairs of complex conjugated nodes.

Proof. — By Lemma 9.4, we can assume that the tropical curve $h: \Gamma \rightarrow \mathbb{R}^2$ is given locally near the edge E by Figure 9.1. Denote by $V_1, V_2 \in \Gamma^{[0]}$ the vertices adjacent to E , and let C_1 and C_2 be the corresponding components of C_0 , meeting at the node P . Let $X_1, X_2 \subset X_0$ be the irreducible components of X_0 corresponding to $h(V_1)$ and $h(V_2)$. Denote by X_E the double locus in X_0 , where X_1 and X_2 intersect.

A chart for the log structure \mathcal{M}_{X_0} , on an open neighbourhood U around the point $\varphi_0(P)$ is given by

$$\begin{aligned}
 \overline{\mathcal{M}}_{X_0}|_U &\longrightarrow \mathcal{M}_{X_0}|_U \\
 \bar{x} &\longmapsto s_x \\
 \bar{y} &\longmapsto s_y \\
 \bar{\gamma} &\longmapsto s_\gamma \\
 \bar{t} &\longmapsto s_t
 \end{aligned}
 \tag{9.3}$$

where $\bar{x} \cdot \bar{y} = \bar{t}^e$. The coordinates x, y, γ on U are such that γ is a toric coordinate along X_E (unlike the γ coordinate used in the proof of Lemma 9.4), X_1 is locally defined by $x = 0$ and X_2 is locally defined by $y = 0$,

Now, before analysing the log structure on the domain curve around C , recall by Definition 4.2, the intersection index of either C_1 or C_2 with X_E is equal to μ . From the proof of Theorem 5.1 it follows that there exists a chart for the log structure \mathcal{M}_C on a neighbourhood V around P given by

$$\begin{aligned}
 \overline{\mathcal{M}}_C|_V &\longrightarrow \mathcal{M}_C|_V \\
 \bar{z} &\longmapsto \zeta^{-1} s_z \\
 \bar{w} &\longmapsto s_w \\
 \bar{t} &\longmapsto s_t^{e/\mu}
 \end{aligned}
 \tag{9.4}$$

where $\bar{z} \cdot \bar{w} = \bar{t}^{e/\mu}$. Moreover, $\zeta = 1$ if μ is odd, and $\zeta \in \{1, -1\}$ if μ is even. The coordinates on V are given by $\{z, w, t \mid z \cdot w = t^{e/\mu}\}$. Now, in the remaining part of this section we assume that the charts for the log structures around P and $\varphi_0(P)$ are given as in (9.4) and (9.3) respectively.

Label the points $\{0_{C_i}, 1_{C_i}, \infty_{C_i}\}$ on each irreducible component C_i mapping to the toric boundary of X_i , and assume that $P = 0_{C_1} = 0_{C_2}$. Let

$$(9.5) \quad \begin{aligned} \varphi_0(1_{C_1}) &= p_1 := (x = c, y = 0, \gamma = 0) \in X_1 \\ \varphi_0(1_{C_2}) &= p_2 := (x = 0, y = c', \gamma = 0) \in X_2 \\ \varphi_0(P) &= p_0 := (x = 0, y = 0, \gamma = d) \in X_E \end{aligned}$$

for some $c, c', d \in \mathbb{R}^\times$. The data of the tropical curve $h: \Gamma \rightarrow \mathbb{R}^2$ given by Figure 9.1 defines the morphisms $\mathcal{M}_{X_0, \varphi_0(x)} \rightarrow \mathcal{M}_{C_0, x}$ on ghost sheaf level for any closed point $x \in C_0$ [5, Section 8]. Moreover, by the definition of the log structure on X_0 , the sections of $\mathcal{M}_{X_0, \varphi_0(x)}$ are obtained by restrictions of regular functions in

$$\mathcal{M}_{\mathcal{X}, \varphi_0(P)} \subset \mathcal{O}_{\mathcal{X}, \varphi_0(P)},$$

where we recall that \mathcal{X} denotes the total space of degeneration. Thus, determining lifts to log morphisms amounts to specifying the values $c, c', d \in \mathbb{R}^\times$, which define the morphism

$$(9.6) \quad \begin{aligned} \mathcal{M}_{\mathcal{X}, \varphi_0(P)} &\longrightarrow \mathcal{M}_{C_0, P} \\ x &\longmapsto cz^\mu \\ y &\longmapsto c'w^\mu \\ \gamma &\longmapsto d(z + w - 1) \\ t &\longmapsto t \end{aligned}$$

Since on a neighbourhood of P , the coordinates satisfy the relation

$$\{z, w, t \mid z \cdot w = t^{e/\mu}\}$$

and on a neighbourhood of $\varphi_0(P)$ on the total space we have the relation

$$\{x, y, \gamma, t \mid x \cdot y = t^e\}$$

we obtain $c' = c^{-1}$. Then, we indeed get a well-defined map in (9.6) because

$$(9.7) \quad xy = cz^\mu c^{-1}w^\mu = (zw)^\mu = (t^{e/\mu})^\mu = t^e.$$

For fixed $t \neq 0$, from (9.7) we get

$$y = \frac{t^e}{x} \quad \text{and} \quad w = \zeta \frac{t^{e/\mu}}{z},$$

and obtain a parametrization of the deformation of $\varphi_0(C_0)$ in a neighbourhood of P , given by

$$\begin{aligned} \mathbb{C}^\times &\longrightarrow (\mathbb{C}^\times)^2 \\ z &\longmapsto (x(z), \gamma(z)) \end{aligned}$$

with

$$(9.8) \quad \begin{aligned} x(z) &= cz^\mu \\ \gamma(z) &= d \left(z + \zeta \frac{t^{e/\mu}}{z} - 1 \right). \end{aligned}$$

The nodal points in the image of the deformation are generated as the images of points $z_1, z_2 \in \mathbb{C}^\times$, with $z_1 \neq z_2$, and

$$(x(z_1), \gamma(z_1)) = (x(z_2), \gamma(z_2)).$$

From the parametrization (9.8), these points are obtained as solutions of the following equations:

$$(9.9) \quad z_1^\mu = z_2^\mu$$

$$(9.10) \quad z_1 + \zeta \frac{t^{e/\mu}}{z_1} = z_2 + \zeta \frac{t^{e/\mu}}{z_2}.$$

From (9.9), since $z_1 \neq z_2$, we obtain $z_2 = \xi z_1$ for some $\xi \in \mathbb{C}$ such that $\xi^\mu = 1$, $\xi \neq 1$. Then (9.10) gives

$$\begin{aligned} z_1 + \zeta \frac{t^{e/\mu}}{z_1} &= \xi z_1 + \zeta \frac{t^{e/\mu}}{\xi z_1} \\ z_1^2 + \zeta t^{e/\mu} &= \xi z_1^2 + \zeta \frac{t^{e/\mu}}{\xi} \\ z_1^2(1 - \xi) &= \zeta t^{e/\mu} \left(\frac{1}{\xi} - 1 \right) \\ z_1^2 &= \zeta \frac{t^{e/\mu}}{\xi}. \end{aligned}$$

It follows that $z_2^2 = (\xi z_1)^2 = \xi \zeta t^{e/\mu}$.

We have $(\mu - 1)$ choices for ξ and two choices of square root of $\zeta \frac{t^{e/\mu}}{\xi}$. Because of the symmetry between z_1 and z_2 , we finally get $\mu - 1$ nodes in the image of the curve.

We now study the real nature of these nodes. We will use the following facts. Assume that z_1 and z_2 are such that $(x(z_1), \gamma(z_1)) = (x(z_2), \gamma(z_2))$ and so define a node in the image curve. If $z_1, z_2 \in \mathbb{R}$, then we get an hyperbolic node. If $z_1 \notin \mathbb{R}$, $z_2 \notin \mathbb{R}$, and $(x(z_1), \gamma(z_1)) \in \mathbb{R}^2$, then we get an elliptic node. If $z_1 \notin \mathbb{R}$, $z_2 \notin \mathbb{R}$, and $(x(z_1), \gamma(z_1)) \notin \mathbb{R}^2$, then we get an imaginary node.

As ζ and $t^{\frac{e}{\mu}}$ only enter the above equation through the combination $\zeta t^{\frac{e}{\mu}}$, flipping the sign of ζ is equivalent to flipping the sign of $t^{\frac{e}{\mu}}$, and so we can assume without loss of generality that $t^{\frac{e}{\mu}} \in \mathbb{R}_{>0}$.

Assume $\zeta = 1$. We then have $z_1^2 = \frac{t^{\frac{e}{\mu}}}{\xi}$ and so $|z_1|^2 = t^{\frac{e}{\mu}}$. It follows that

$$\frac{t^{\frac{e}{\mu}}}{z_1} = \frac{|z_1|^2}{z_1} = \bar{z}_1$$

and so

$$\gamma(z_1) = d(z_1 + \bar{z}_1 - 1) = d(2 \operatorname{Re}(z_1) - 1) \in \mathbb{R}.$$

On the other hand, we have $z_1^{2\mu} = t^e$, so $z_1^\mu = \pm t^{\frac{e}{2}}$ and $\alpha(z_1) = \pm ct^{\frac{e}{2}} \in \mathbb{R}$. The upshot is that the node is elliptic.

Assume $\zeta = -1$. We then have $z_1^2 = -\frac{t^{\frac{e}{\mu}}}{\xi}$ and so $|z_1|^2 = t^{\frac{e}{\mu}}$. It follows that

$$\frac{t^{\frac{e}{\mu}}}{z_1} = \frac{|z_1|^2}{z_1} = \bar{z}_1$$

and so

$$\gamma(z_1) = d(z_1 - \bar{z}_1 - 1) = d(2i \operatorname{Im} z_1 - 1).$$

If $\xi \notin \mathbb{R}$, which is always the case if μ is odd, then $z_1 \notin \mathbb{R}$, so $\gamma(z_1) \notin \mathbb{R}$ and therefore the node is imaginary. If $\xi \in \mathbb{R}$, which is only the case if μ is even and then $\xi = -1$, we have $z_1^2 = t^{\frac{e}{\mu}}$ and $z_2^2 = t^{\frac{e}{\mu}}$, so $z_1, z_2 \in \mathbb{R}$, and therefore the node is hyperbolic.

We can now summarize the results. If μ is odd, then $\zeta = 1$ and all the $(\mu - 1)$ nodes are elliptic. If μ is even and $\zeta = 1$, then all the $(\mu - 1)$ nodes are elliptic. If μ is even and $\zeta = -1$, then the node corresponding to $\xi = -1$ is hyperbolic, and the $\mu - 2$ other nodes corresponding to $\xi \neq -1$ are imaginary nodes. □

9.4. Nodes which are preserved under the deformation.

In this section we analyse the types of nodes that appear in the image of a maximally degenerate real stable log map $\varphi_0: C_0 \rightarrow X_0$ and which are contained in the smooth locus of X_0 . They will deform into locally isomorphic nodes in the deformation $\varphi_t: C_t \rightarrow X_t$.

Recall that nodal points on the image of φ_0 are generated, if two points of C_0 , say p_1, p_2 map to the point under the map $\varphi_0: C_0 \rightarrow X_0$. There are two possible cases:

- (i) The points p_1, p_2 are points on different irreducible components of C_0 .
- (ii) The points p_1, p_2 belong to the same irreducible component of C_0 .

We focus on nodes of $\varphi_0(C_0)$ contained in the smooth locus of X_0 , and we will analyse the types of the nodes in each case separately. The following lemma shows that in the first case we only obtain hyperbolic nodes.

LEMMA 9.6. — *Let $\varphi_0: C_0 \rightarrow X_0$ be a real maximally degenerate stable log map with associated tropical curve $(h: \Gamma \rightarrow M_{\mathbb{R}} \cong \mathbb{R}^2) \in \mathfrak{T}_{g,\ell,\Delta}(\mathbf{A})$. Every node in the image of $\varphi_0(C_0)$ that is contained in the smooth locus of X_0 and that is obtained from identification by φ_0 of two points lying on different irreducible components of C_0 is hyperbolic.*

Proof. — Let $p_1, p_2 \in C_0$ be two distinct points mapping by φ_0 to the same point $\varphi_0(p_1) = \varphi_0(p_2)$ contained in the smooth locus of X_0 . Assume that p_1 and p_2 lie on different irreducible components $C_{0,1}$ and $C_{0,2}$ of C_0 . As φ_0 is a real map, this can only happen if either p_1 and p_2 are complex conjugated, in which case p is elliptic, or if p_1 and p_2 are real, in which case p is hyperbolic. We will show that the latter case is realized.

We denote the vertices of Γ corresponding to $C_{0,1}$ and $C_{0,2}$ by V_1 and V_2 respectively, and let X_p be the irreducible component of X_0 corresponding to the vertex $h(V_1) = h(V_2)$ in the image of φ_0 . Since h is a general tropical curve, two vertices $V_1, V_2 \in \Gamma$ can map to the same point transversally only if they are bivalent vertices, and create a 4-valent vertex, so that $X_p \cong \mathbb{P}^1 \times \mathbb{P}^1$. In particular, the homology classes of $\varphi_0(C_{0,1})$ and $\varphi_0(C_{0,2})$ in X_p are distinct. As the real involution of X_p acts trivially on the homology of X_p , we deduce that the components $C_{0,1}$ and $C_{0,2}$ are not complex-conjugated but are each preserved by the real involution of C_0 . Therefore, the points p_1 and p_2 are not complex-conjugated and are both real. It follows that p is an hyperbolic node of $\varphi_0(C_0)$. \square

Next we will analyse the second case, assuming two points p_1, p_2 belonging to the same component of C_0 map to the same point under $\varphi_0: C_0 \rightarrow X_0$. Let $V = \varphi_0(p_1) = \varphi_0(p_2)$ denote the vertex in the image of the tropicalization $h: \Gamma \rightarrow \mathbb{R}^2$, and let X_V denote the irreducible component of X_V corresponding to V . We will denote the restriction of φ_0 to the \mathbb{P}^1 -component of C_0 containing p_1, p_2 as

$$(9.11) \quad \varphi: \mathbb{P}^1 \longrightarrow X_V.$$

PROPOSITION 9.7. — *Let V be a trivalent vertex of Γ . Then all real nodes in the image of the map $\varphi: \mathbb{P}^1 \rightarrow X_V$ in (9.11) are elliptic.*

Proof. — Let $(\mathbf{u}, \mathbf{w}) = ((u_i)_{1 \leq i \leq 3}, (w_i)_{1 \leq i \leq 3})$ be the tuple of direction vectors and weights associated to the edges E_i adjacent to V , for $i \in \{1, 2, 3\}$. Denote by D_i the toric divisor of X_V corresponding to E_i . As in the proof of Lemma 4.9, the real line $\varphi: \mathbb{P}^1 \rightarrow X_V$ in X_V of type (\mathbf{u}, \mathbf{w})

is defined by the equation

$$(9.12) \quad \varphi^\times(z^n) = \chi_\varphi(n) \prod_{i=1}^3 (y - y(q_i))^{(w_i u_i, n)}$$

for every $n \in N$, where χ_φ is a real character of N , and denotes y the unique real coordinate on \mathbb{P}^1 . By $y(q_i)$ we denote the coordinate of the point $q_i \in \mathbb{P}^1$ whose image under φ intersects the toric boundary divisor D_i , and we assume $y(q_1) = -1, y(q_2) = 0, y(q_3) = 1$.

Now let us assume that a real node of $\varphi(\mathbb{P}^1)$ is hyperbolic. Then, we can find y and y' real with $y \neq y'$ and $\varphi(y) = \varphi(y')$. Using (9.12), the condition $\varphi(y) = \varphi(y')$ can be rewritten as

$$(9.13) \quad \prod_{i=1}^3 (y - y(q_i))^{(w_i u_i, n)} = \prod_{i=1}^3 (y' - y(q_i))^{(w_i u_i, n)}$$

for every $n \in N$. Applying (9.13) to $n = \det(\cdot, w_1 u_1)$, we obtain

$$(9.14) \quad \left(\frac{y + 1}{y' + 1}\right)^\mu = \left(\frac{y}{y'}\right)^\mu,$$

where, recalling from Definition 2.1 the balancing condition (2.1) $w_1 u_1 + w_2 u_2 + w_3 u_3 = 0$, we have

$$\mu := w_1 w_2 \det(u_1, u_2) = w_3 w_1 \det(u_3, u_1) = w_2 w_3 \det(u_2, u_3),$$

which equals the multiplicity of the vertex V possibly up to a sign. As both $\frac{y+1}{y'+1}$ and $\frac{y}{y'}$ are real, it follows from (9.14) that either

$$(9.15) \quad \frac{y + 1}{y' + 1} = \frac{y}{y'}$$

or

$$(9.16) \quad \frac{y + 1}{y' + 1} = -\frac{y}{y'}.$$

But (9.15) implies $y = y'$, in contradiction with the assumption that $y \neq y'$. Therefore, (9.16) holds and so we have

$$(9.17) \quad 2yy' = -y - y'.$$

Applying (9.13) to $n = \det(-, w_3 u_3)$, we obtain

$$(9.18) \quad \left(\frac{y - 1}{y' - 1}\right)^\mu = \left(\frac{y}{y'}\right)^\mu.$$

As both $\frac{y-1}{y'-1}$ and $\frac{y}{y'}$ are real, it follows from (9.18) that either

$$(9.19) \quad \frac{y - 1}{y' - 1} = \frac{y}{y'}$$

or

$$(9.20) \quad \frac{y - 1}{y' - 1} = -\frac{y}{y'}.$$

But (9.19) implies $y = y'$, in contradiction with the assumption that $y \neq y'$. Therefore, (9.20) holds and so we have

$$(9.21) \quad 2yy' = y + y'.$$

Comparing (9.17) and (9.21), we obtain first $yy' = 0$ and then $y = y' = 0$, which is a contradiction with the assumption $y \neq y'$.

Therefore, we conclude that $\varphi(\mathbb{P}^1)$ does not admit hyperbolic real nodes and so all the real nodes of $\varphi(\mathbb{P}^1)$ are elliptic. □

9.5. Correspondence theorem with Welschinger signs

We specialise the setup of Section 7 with rank $M = 2$ and zero-dimensional constraints $\mathbf{A} = (A_1, \dots, A_\ell)$. For $t \in \mathbb{A}^1(\mathbb{R}) \setminus \{0\} \simeq \mathbb{R}^\times$ general, we have a finite set $M_{(g,\Delta,\mathbf{A},\mathbf{P}),t}^{\mathbb{R}\text{-log}}$ of real stable log maps to X_t matching the constraints $\mathbf{Z}_{\mathbf{A},\mathbf{P},t}$. By Proposition 9.2, for every $(\varphi: C \rightarrow X)$ element of $M_{(g,\Delta,\mathbf{A},\mathbf{P}),t}^{\mathbb{R}\text{-log}}$, the real curve $\varphi(C)$ is nodal, and so it makes sense to define $\mathcal{W}^{\text{log}}(\varphi)$ following Definition 9.3. We define *log Welschinger numbers*

$$\mathcal{W}_{(g,\Delta,\mathbf{A},\mathbf{P}),t}^{\mathbb{R}\text{-log}} := \sum_{\varphi \in M_{(g,\Delta,\mathbf{A},\mathbf{P}),t}^{\mathbb{R}\text{-log}}} \mathcal{W}^{\text{log}}(\varphi).$$

On the other hand, we have finite set $\mathfrak{T}_{g,\ell,\Delta}(\mathbf{A})$ of tropical curves matching the tropical constraints \mathbf{A} . For every (Γ, \mathbf{E}, h) element of $\mathfrak{T}_{g,\ell,\Delta}^{\mathbb{R}\text{-log}}$, we can define $\text{Mult}_{\mathbb{R}}(h)$ following Definition 8.3. We define *tropical Welschinger numbers*

$$\mathcal{W}_{(g,\Delta,\mathbf{A},\mathbf{P})}^{\mathbb{R}\text{-trop}} := \sum_{(\Gamma, \mathbf{E}, h) \in \mathcal{T}_{g,\ell,\Delta}(\mathbf{A})} \text{Mult}_{\mathbb{R}}(h).$$

THEOREM 9.8. — *For every $t \in \mathbb{A}^1(\mathbb{R}) \setminus \{0\} \simeq \mathbb{R}^\times$ sufficiently close to 0, we have*

$$(9.22) \quad \mathcal{W}_{(g,\Delta,\mathbf{A},\mathbf{P}),t}^{\mathbb{R}\text{-log}} = \mathcal{W}_{(g,\Delta,\mathbf{A},\mathbf{P})}^{\mathbb{R}\text{-trop}}.$$

Proof. — Let $\varphi_0: \underline{C}_0 \rightarrow X_0$ be a maximally degenerate real stable map. Let $h: \Gamma \rightarrow M_{\mathbb{R}}$ be the corresponding tropical curve. The proof is divided into two cases: either Γ contains one bounded edge of even weight, or all the bounded edges of Γ have odd weight.

Let us assume that Γ contains a bounded edge E of even weight $w(E)$. By Theorem 5.1, in trying to lift $\varphi_0: \underline{C}_0 \rightarrow X_0$ to a real stable log map

$\varphi_0: C_0 \rightarrow X_0$, we have two choices for each bounded edge of Γ of even weight, labeled by $\zeta = 1$ or $\zeta = -1$. Therefore, we can divide all real log lifts of φ_0 into pairs, where two elements φ_0^+ and φ_0^- of a pair only differ by the sign of ζ specifying the log structure at the node corresponding to the edge E . By Theorem 9.5, the nodes of the image curves of the deformations φ_t^+ and φ_t^- of φ_0^+ and φ_0^- are in a one-to-one correspondence preserving the real type, except for the nodes created by the smoothing of the node p_E of \underline{C}_0 corresponding to the edge E . For either φ_t^+ and φ_t^- , the $w(E) - 1$ nodes of the image curve created by the smoothing of p_E are all real elliptic, whereas for the other, the $w(E) - 1$ nodes of the image curve created by the smoothing of p_E split into one real hyperbolic node and $w(E) - 2$ non-real nodes. It follows that the contributions of φ_+ and φ_- to $\mathcal{W}_{(g,\Delta,\mathbf{A},\mathbf{P}),t}^{\mathbb{R}\text{-log}}$ differ by $(-1)^{w(E)-1} = -1$ and so they cancel. Therefore, the total contribution to $\mathcal{W}_{(g,\Delta,\mathbf{A},\mathbf{P}),t}^{\mathbb{R}\text{-log}}$ of all the real log lifts of φ_0 is zero. On the other hand, the contribution of the tropical curve $h: \Gamma \rightarrow M_{\mathbb{R}}$ to $\mathcal{W}_{(g,\Delta,\mathbf{A},\mathbf{P})}^{\mathbb{R}\text{-trop}}$ is also zero by Definition 8.3.

Let us assume that all edges of Γ have odd weight. By Theorem 5.1, there is a unique lift of φ_0 to a real stable log map $\varphi_0: C_0 \rightarrow X_0$. Let $\varphi_t: C_t \rightarrow X_t$ be the deformation of φ_0 . By Definition 9.3, the contribution of φ_t to $\mathcal{W}_{(g,\Delta,\mathbf{A},\mathbf{P}),t}^{\mathbb{R}\text{-log}}$ is $\mathcal{W}(\varphi_t) = (-1)^{m(\varphi_t)}$, where $m(\varphi_t)$ is the number of elliptic nodes of $\varphi_t(C_t)$. Nodes of $\varphi_t(C_t)$ fall into three categories.

First, there are nodes of $\varphi_t(C_t)$ produced by the smoothing of a node p_E of φ_0 corresponding to an edge E of Γ of weight $w(E)$. By Theorem 5.1, for every edge E of Γ , there are $w(E) - 1$ such nodes, all real elliptic. As $w(E)$ is odd, $w(E) - 1$ is even, so the total factor contribution of these nodes to $\mathcal{W}(\varphi_t)$ is 1.

Second, there are nodes of $\varphi_t(C_t)$ which are deformation of nodes of $\varphi_0(C_0)$ where the images by φ_0 of two irreducible components of C_0 intersect. All these nodes are real hyperbolic by Lemma 9.6 and so their factor contribution to $\mathcal{W}(\varphi_t)$ is 1.

Third, there are nodes of $\varphi_t(C_t)$ which are deformation of nodes of $\varphi_0(C_0)$ where the image by φ_0 of an irreducible component C_V of C_0 self-intersects. Let V be the vertex of Γ corresponding to C_V . By Proposition 9.7, all real nodes of $\varphi_0(C_V)$ are elliptic. On the other hand, the total number of nodes of $\varphi_0(C_V)$ is the number I_{Δ_V} of integral points in the interior of the triangle Δ_V dual to V . As the total numbers of nodes and the number of real nodes have the same parity (because differing by the numbers of non-real nodes which come in complex conjugated pairs), we deduce that

the factor contribution of the nodes of $\varphi_t(c_t)$ which are deformation of the nodes of $\varphi_0(C_V)$ is $(-1)^{I_{\Delta_V}}$.

In conclusion, we get $\mathcal{W}(\varphi_t) = \prod_V (-1)^{I_{\Delta_V}}$, which is equal to the contribution $\text{Mult}_{\mathbb{R}}(h)$ of $h: \Gamma \rightarrow M_{\mathbb{R}}$ to $\mathcal{W}_{(g,\Delta,\mathbf{A},\mathbf{P})}^{\mathbb{R}\text{-trop}}$ by Definition 8.3. \square

9.6. Welschinger invariants

Let (X, ω, ι_X) be a compact 4-manifold endowed with a symplectic form ω and an anti-symplectic involution ι_X , that is, such that $\iota_X^* \omega = -\omega$. Fix $d \in H_2(X; \mathbb{Z})$ such that $c_1(X) \cdot d > 0$, and let $x \subset X$ be a generic configuration of $c_1(X) \cdot d - 1$ distinct real (ι_X -fixed) points in X . For a generic almost complex structure J tamed by ω , there are finitely many J -holomorphic rational curves in X of degree d and passing through x , all nodal. In particular, finitely many of these curves are real (that is ι_X -invariant). The count of J -holomorphic rational curves in X of degree d and passing through x does not depend on J and x : it is a genus 0 degree d Gromov–Witten invariant. By contrast, the count of real J -holomorphic rational curves in X of degree d and passing through x is not invariant in general under variation of J and x . Welschinger [49, 50] understood how to construct an invariant by considering a signed count of real J -holomorphic rational curves in X .

The following definition of Welschinger signs can be found in [50, Section 2.1].

DEFINITION 9.9. — *Let C be a nodal real irreducible rational pseudo-holomorphic curve in a real rational symplectic 4-manifold X with homology class $d \in H_2(X, \mathbb{Z})$. The Welschinger sign of C is defined as*

$$(9.23) \quad \mathcal{W}(C) := (-1)^{m(C)}$$

where $m(C)$, referred to as the mass of C , is the total number of elliptic nodes of C .

Note that by the adjunction formula, a nodal rational curve of degree d in a symplectic 4-manifold has a total number of nodes equal to

$$(9.24) \quad \delta = \frac{d \cdot d - c_1(X) \cdot d + 2}{2}.$$

The following result is due to Welschinger.

THEOREM 9.10 ([49, Theorem 2.1]). — *For every integer m ranging from 0 to δ , denote by $n_d(m)$ the total number of real J -holomorphic rational curves of mass m in X passing through x and realizing the homology*

class d . Then, the number

$$(9.25) \quad \mathcal{W}_{X,d}^{\mathbb{R}\text{-symp}}(x, J) = \sum_{m=0}^{\delta} (-1)^m n_d(m)$$

is invariant; it neither depends on the choice of J nor on the choice of x and we denote it by $\mathcal{W}_{X,d}^{\mathbb{R}\text{-symp}}$.

Let X be a smooth toric del Pezzo surface and $d \in H_2(X, \mathbb{Z})$ such that $c_1(X) \cdot d - 1 > 0$. Let $\mathcal{W}_{X,d}^{\mathbb{R}\text{-symp}}$ be the corresponding Welschinger invariant. Let $\Delta_v: M \setminus \{0\} \rightarrow \mathbb{N}$ be the tropical degree defined by $\Delta_d(v) = d \cdot D_v$ if v is the primitive generator of a ray of the fan of X corresponding to the toric divisor D_v , and $\Delta_d(v) = 0$ else.

COROLLARY 9.11. — We have

$$\mathcal{W}_{X,d}^{\mathbb{R}\text{-symp}} = \mathcal{W}_{(0, \Delta_d, \mathbf{A}, \mathbf{P})}^{\mathbb{R}\text{-trop}}.$$

Proof. — By [26], for a toric del Pezzo surface X , Welschinger invariants are counts with Welschinger signs of real rational curves in X for the standard integrable complex structure of X and passing through a generic configuration of real points. Furthermore every such curve is torically transverse. Therefore, considering a toric degeneration as in the setting of Theorem 9.8, we have

$$\mathcal{W}_{X,d}^{\mathbb{R}\text{-symp}} = \mathcal{W}_{(g, \Delta, \mathbf{A}, \mathbf{P}), t}^{\mathbb{R}\text{-log}}$$

for every $t \in \mathbb{A}^1(\mathbb{R}) \setminus \{0\} \simeq \mathbb{R}^\times$ general, and so the result follows from Theorem 9.8. □

BIBLIOGRAPHY

- [1] D. ABRAMOVICH & Q. CHEN, “Stable logarithmic maps to Deligne–Faltings pairs II”, *Asian J. Math.* **18** (2014), no. 3, p. 465–488.
- [2] D. ABRAMOVICH, Q. CHEN, M. GROSS & B. SIEBERT, “Decomposition of degenerate Gromov–Witten invariants”, *Compos. Math.* **156** (2020), no. 10, p. 2020–2075.
- [3] H. ARGÜZ, “Real loci in (log-) Calabi–Yau manifolds via Kato–Nakayama spaces of toric degenerations”, 2016, <https://arxiv.org/abs/1610.07195>.
- [4] ———, “Log geometric techniques for open invariants in mirror symmetry”, PhD Thesis, University of Hamburg, 2017.
- [5] ———, “A tropical and log geometric approach to algebraic structures in the ring of theta functions”, 2017, <https://arxiv.org/abs/1712.10260>.
- [6] ———, “Topological torus fibrations on Calabi–Yau manifolds via Kato–Nakayama spaces”, to appear in *Eur. J. Math.*, 2020, <https://arxiv.org/abs/2003.11589>.
- [7] P. BOUSSEAU, “A proof of N. Takahashi’s conjecture for (\mathbb{P}^2, E) and a refined sheaves/Gromov–Witten correspondence”, 2019, <https://arxiv.org/abs/1909.02992>.

- [8] ———, “The quantum tropical vertex”, *Geom. Topol.* **24** (2020), no. 3, p. 1297-1379.
- [9] E. BRUGALÉ & G. MIKHALKIN, “Enumeration of curves via floor diagrams”, *C. R. Math. Acad. Sci. Paris* **345** (2007), no. 6, p. 329-334.
- [10] ———, “Floor decompositions of tropical curves: the planar case”, in *Proceedings of Gökova Geometry-Topology Conference 2008*, International Press, 2009, p. 64-90.
- [11] M.-W. CHEUNG, L. FANTINI, J. PARK & M. ULIRSCH, “Faithful realizability of tropical curves”, *Int. Math. Res. Not.* (2016), no. 15, p. 4706-4727.
- [12] S. A. FILIPPINI & J. STOPPA, “Block–Göttsche invariants from wall-crossing”, *Compos. Math.* **151** (2015), no. 8, p. 1543-1567.
- [13] W. FULTON, *Introduction to toric varieties*, Annals of Mathematics Studies, vol. 131, Princeton University Press, 1993, xii+157 pages.
- [14] A. GATHMANN, H. MARKWIG & F. SCHROETER, “Broccoli curves and the tropical invariance of Welschinger numbers”, *Adv. Math.* **240** (2013), p. 520-574.
- [15] P. GEORGIEVA & A. ZINGER, “Real Gromov–Witten theory in all genera and real enumerative geometry: construction”, *Ann. Math.* **188** (2018), no. 3, p. 685-752.
- [16] ———, “Real Gromov–Witten theory in all genera and real enumerative geometry: computation”, *J. Differ. Geom.* **113** (2019), no. 3, p. 417-491.
- [17] ———, “Real Gromov–Witten theory in all genera and real enumerative geometry: properties”, *J. Symplectic Geom.* **17** (2019), no. 4, p. 1083-1158.
- [18] A. GROSS, “Correspondence theorems via tropicalizations of moduli spaces”, *Commun. Contemp. Math.* **18** (2016), no. 3, article no. 1550043 (36 pages).
- [19] M. GROSS, *Tropical geometry and mirror symmetry*, CBMS Regional Conference Series in Mathematics, vol. 114, American Mathematical Society, 2011, xvi+317 pages.
- [20] M. GROSS, R. PANDHARIPANDE & B. SIEBERT, “The tropical vertex”, *Duke Math. J.* **153** (2010), no. 2, p. 297-362.
- [21] M. GROSS & B. SIEBERT, “Mirror symmetry via logarithmic degeneration data. I”, *J. Differ. Geom.* **72** (2006), no. 2, p. 169-338.
- [22] ———, “Logarithmic Gromov–Witten invariants”, *J. Am. Math. Soc.* **26** (2013), no. 2, p. 451-510.
- [23] I. ITENBERG, V. KHARLAMOV & E. SHUSTIN, “Welschinger invariant and enumeration of real rational curves”, *Int. Math. Res. Not.* (2003), no. 49, p. 2639-2653.
- [24] ———, “Logarithmic equivalence of the Welschinger and the Gromov–Witten invariants”, *Usp. Mat. Nauk* **59** (2004), no. 6(360), p. 85-110.
- [25] ———, “A Caporaso–Harris type formula for Welschinger invariants of real toric del Pezzo surfaces”, *Comment. Math. Helv.* **84** (2009), no. 1, p. 87-126.
- [26] ———, “Welschinger invariants revisited”, in *Analysis meets geometry*, Trends in Mathematics, Birkhäuser/Springer, 2017, p. 239-260.
- [27] I. ITENBERG, G. MIKHALKIN & E. SHUSTIN, *Tropical algebraic geometry*, second ed., Oberwolfach Seminars, vol. 35, Birkhäuser, 2009, x+104 pages.
- [28] F. KATO, “Log smooth deformation theory”, *Tôhoku Math. J.* **48** (1996), no. 3, p. 317-354.
- [29] ———, “Log smooth deformation and moduli of log smooth curves”, *Int. J. Math.* **11** (2000), no. 2, p. 215-232.
- [30] K. KATO, “Logarithmic structures of Fontaine–Illusie”, in *Algebraic analysis, geometry, and number theory (Baltimore, MD, 1988)*, Johns Hopkins University Press, 1989, p. 191-224.
- [31] T. MANDEL & H. RUDDAT, “Descendant log Gromov–Witten invariants for toric varieties and tropical curves”, *Trans. Am. Math. Soc.* **373** (2020), no. 2, p. 1109-1152.

- [32] G. MIKHALKIN, “Enumerative tropical algebraic geometry in \mathbb{R}^2 ”, *J. Am. Math. Soc.* **18** (2005), no. 2, p. 313-377.
- [33] T. NISHINO, “Correspondence theorems for tropical curves”, 2009, <https://arxiv.org/abs/0912.5090v1>.
- [34] T. NISHINO & B. SIEBERT, “Toric degenerations of toric varieties and tropical curves”, *Duke Math. J.* **135** (2006), no. 1, p. 1-51.
- [35] A. OGUS, *Lectures on logarithmic algebraic geometry*, Cambridge Studies in Advanced Mathematics, vol. 178, Cambridge University Press, 2018, xviii+539 pages.
- [36] D. RANGANATHAN, “Skeletons of stable maps I: rational curves in toric varieties”, *J. Lond. Math. Soc.* **95** (2017), no. 3, p. 804-832.
- [37] E. SHUSTIN, “A tropical approach to enumerative geometry”, *Algebra Anal.* **17** (2005), no. 2, p. 170-214.
- [38] ———, “A tropical calculation of the Welschinger invariants of real toric del Pezzo surfaces”, *J. Algebr. Geom.* **15** (2006), no. 2, p. 285-322.
- [39] E. SHUSTIN & I. TYOMKIN, “Patchworking singular algebraic curves. I”, *Isr. J. Math.* **151** (2006), p. 125-144.
- [40] ———, “Patchworking singular algebraic curves. II”, *Isr. J. Math.* **151** (2006), p. 145-166.
- [41] J. P. SOLOMON, “Intersection theory on the moduli space of holomorphic curves with Lagrangian boundary conditions”, PhD Thesis, Massachusetts Institute of Technology, 2006, <https://www.proquest.com/docview/304947035>.
- [42] J. P. SOLOMON & S. TUKACHINSKY, “Point like bounding chains in open Gromov–Witten theory”, 2016, <https://arxiv.org/abs/1608.02495>.
- [43] I. TYOMKIN, “Tropical geometry and correspondence theorems via toric stacks”, *Math. Ann.* **353** (2012), no. 3, p. 945-995.
- [44] ———, “Enumeration of rational curves with cross-ratio constraints”, *Adv. Math.* **305** (2017), p. 1356-1383.
- [45] O. Y. VIRO, “Gluing of plane real algebraic curves and constructions of curves of degrees 6 and 7”, in *Topology (Leningrad, 1982)*, Lecture Notes in Mathematics, vol. 1060, Springer, 1984, p. 187-200.
- [46] ———, “Real plane algebraic curves: constructions with controlled topology”, *Algebra Anal.* **1** (1989), no. 5, p. 1-73.
- [47] ———, “Patchworking real algebraic varieties”, 2006, <https://arxiv.org/abs/math/0611382>.
- [48] C. A. WEIBEL, *An introduction to homological algebra*, Cambridge Studies in Advanced Mathematics, vol. 38, Cambridge University Press, 1994, xiv+450 pages.
- [49] J.-Y. WELSCHINGER, “Invariants of real rational symplectic 4-manifolds and lower bounds in real enumerative geometry”, *C. R. Math. Acad. Sci. Paris* **336** (2003), no. 4, p. 341-344.
- [50] ———, “Invariants of real symplectic 4-manifolds and lower bounds in real enumerative geometry”, *Invent. Math.* **162** (2005), no. 1, p. 195-234.
- [51] ———, “Spinor states of real rational curves in real algebraic convex 3-manifolds and enumerative invariants”, *Duke Math. J.* **127** (2005), no. 1, p. 89-121.
- [52] ———, “Open Gromov–Witten invariants in dimension six”, *Math. Ann.* **356** (2013), no. 3, p. 1163-1182.

Manuscrit reçu le 25 mai 2020,
révisé le 8 mars 2021,
accepté le 8 avril 2021.

Hülya ARGÜZ
Laboratoire de Mathématiques
Université de Versailles
St Quentin en Yvelines (France)
nuromur-hulya.arguz@uvsq.fr

Pierrick BOUSSEAU
Université Paris-Saclay, CNRS
Laboratoire de mathématiques d'Orsay
91405 Orsay (France)
pierrick.bousseau@universite-paris-saclay.fr